

Copia y relaciona:

CHOPO

.....



CHAPA

.....



CHOCOLATE

.....



CHINO

.....

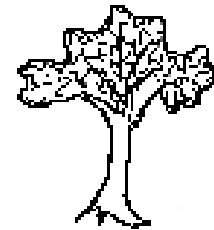

CHAQUETA

.....



CHIMEMEA

.....



Copia y relaciona:

chopo

.....



chimenea

.....



chaqueta

.....



chino

.....



chapa

.....

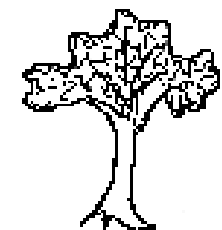

chocolate

.....



Copia y relaciona:

chapa

.....



chocolate

.....



chopo

.....



chimenea

.....

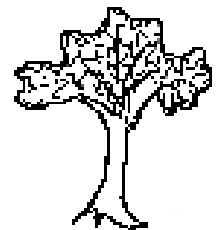

chaqueta

.....



chapa

.....



Relaciona:

CHAPA

chaqueta

chocolate

CHAQUETA

chopo

chimenea

CHIMENEA

chapa

chino

CHOCOLATE

chocolate

chapa

CHOPO

chimenea

chaqueta

CHINO

chino

chopo

Escribe:

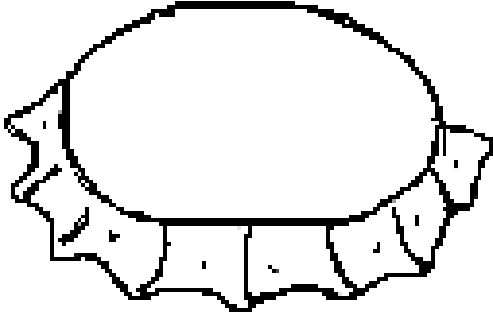
	CHA	PA
	CHE	PE
	CHI	PI
	CHO	PO
	CHU	PU

	CHA	CA	TA
	CHE	QUE	TE
	CHI	QUI	TI
	CHO	CO	TO
	CHU	CU	TU

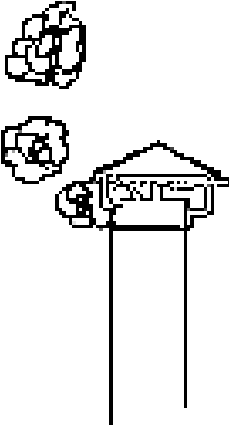
	CHA	MA	NA	A
	CHE	ME	NE	E
	CHI	MI	NI	I
	CHO	MO	NO	O
	CHU	MU	NU	U

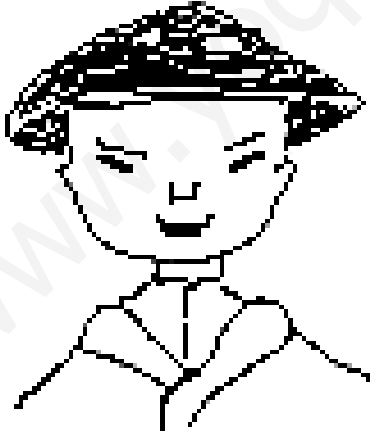
	CHA	NA
	CHE	NE
	CHI	NI
	CHO	NO
	CHU	NU

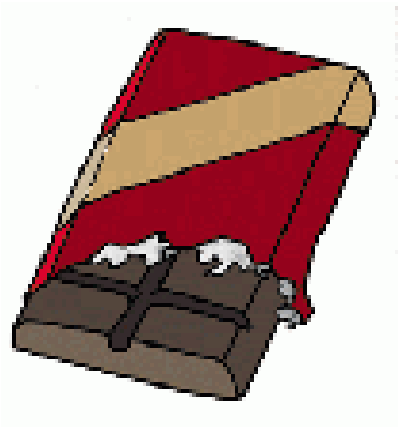

CHA	CA	LA	TA
CHE	QUE	LE	TE
CHI	QUI	LI	TI
CHO	CO	LO	TO
CHU	CU	LU	TU

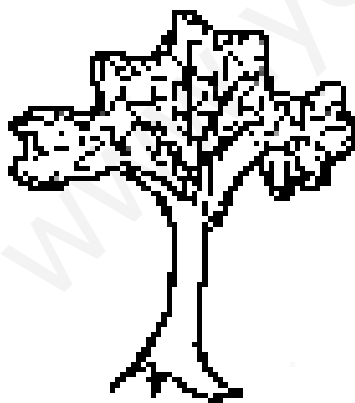

CA	SA
QUE	SE
QUI	SI
CO	SO
CU	SU

Dibuja:

chino

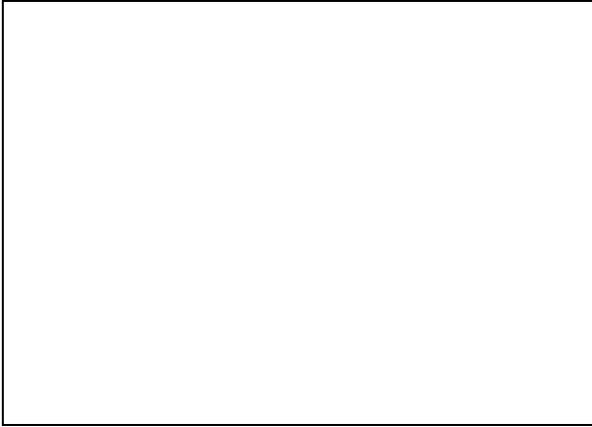

chopo



chocolate



chimenea

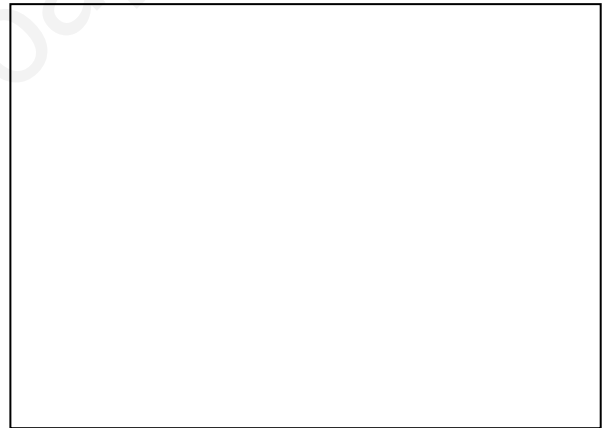

chapa



chaqueta



Escribe:

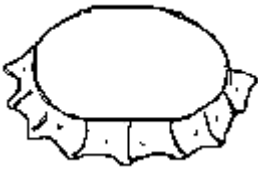

.....



.....

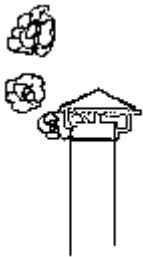

.....



.....



.....

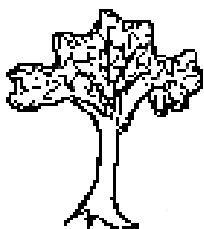

.....

www.yoquieroaprobar.es

Copia y relaciona:

DUCHA

.....



CHULETA

.....



CHUPETE

.....



LECHE

.....



COCHE

.....

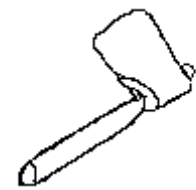

HACHA

.....



Copia y relaciona:

chuleta

.....



ducha

.....



chupete

.....



leche

.....



hacha

.....

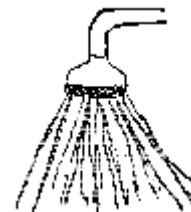

coche

.....

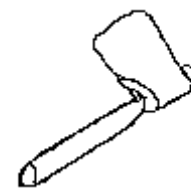

Copia y relaciona:

hacha

.....

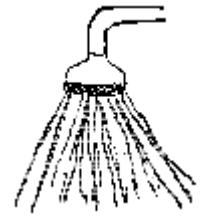

ducha

.....

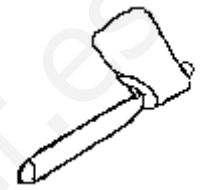

coche

.....



chuleta

.....



chupete

.....

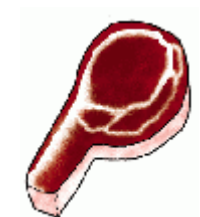

hacha

.....



Relaciona:

DUCHA

hacha

chupete

CHULETA

chuleta

hacha

CHUPETE

ducha

chuleta

LECHE

coche

leche

COCHE

chupete

ducha

HACHA

leche

coche

Escribe:

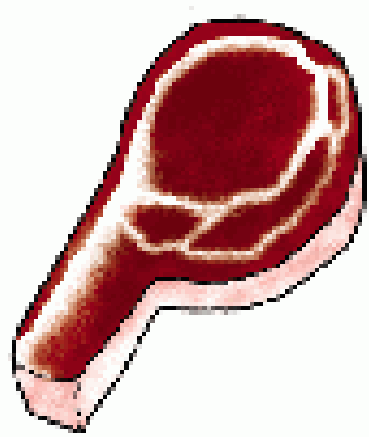
	CHA	LA	TA
	CHE	LE	TE
	CHI	LI	TI
	CHO	LO	TO
	CHU	LU	TU

	CA	CHA
	QUE	CHE
	QUI	CHI
	CO	CHO
	CU	CHU

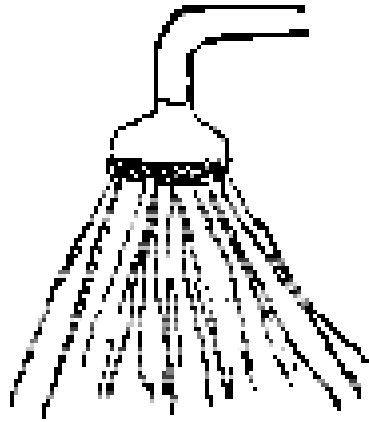

DA

CHA

DE

CHE

DI

CHI

DO

CHO

DU

CHU

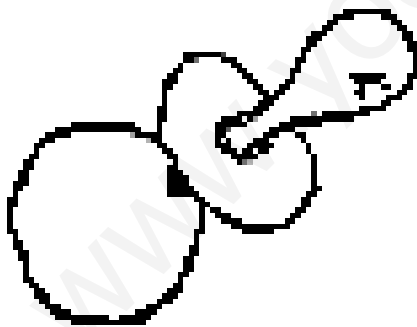

CHA

PA

TA

CHE

PE

TE

CHI

PI

TI

CHO

PO

TO

CHU

PU

TU

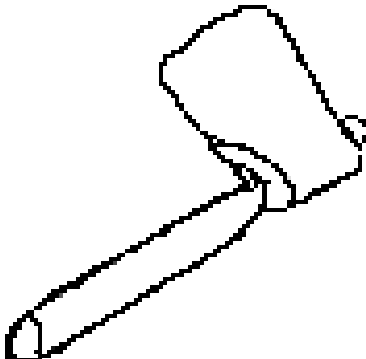
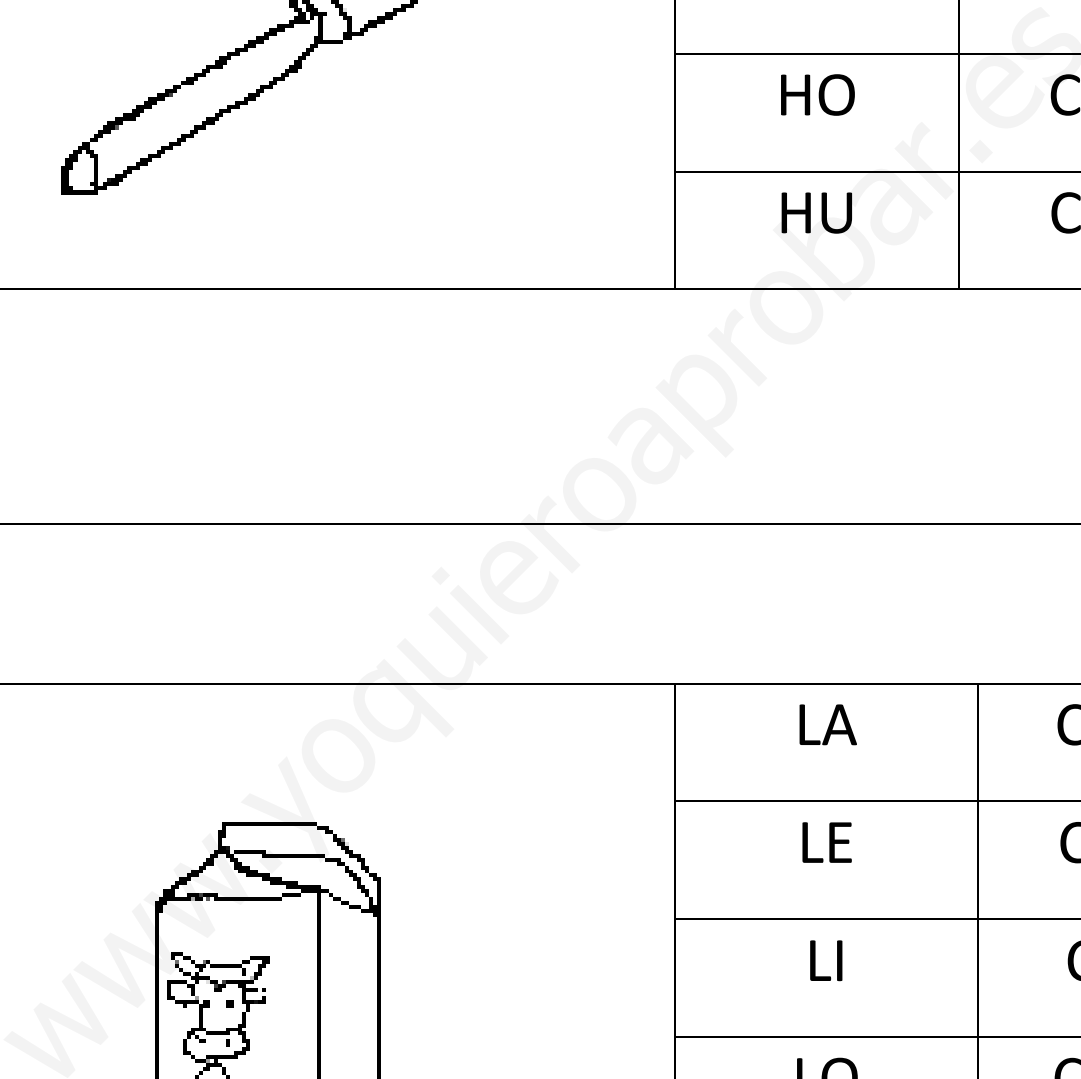
	HA	CHA
	HE	CHE
	HI	CHI
	HO	CHO
	HU	CHU
<div style="text-align: center;">  </div>		

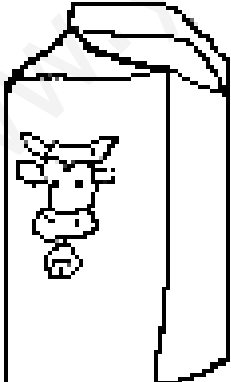
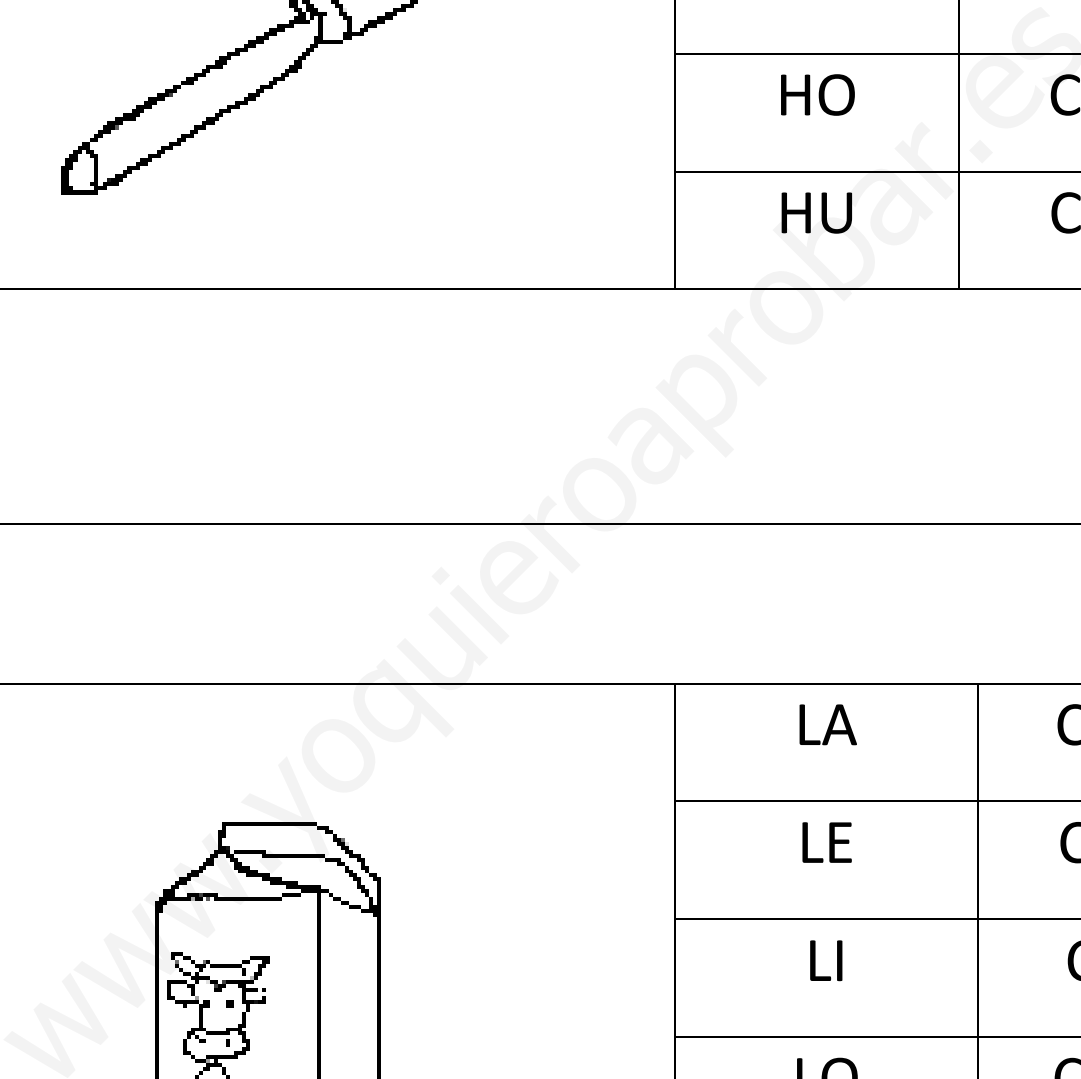
	LA	CHA
	LE	CHE
	LI	CHI
	LO	CHO
	LU	CHU
<div style="text-align: center;">  </div>		

Dibuja:

chuleta

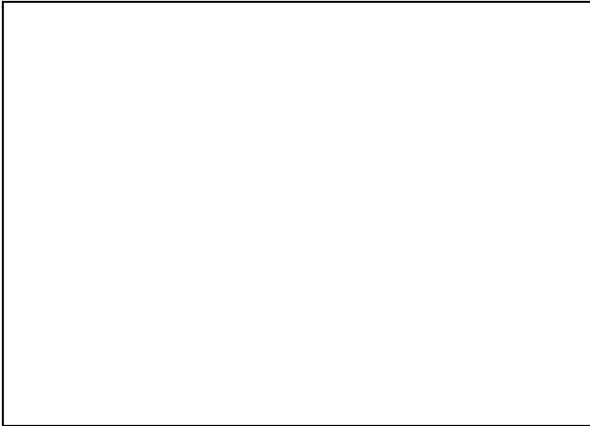

hacha



chupete

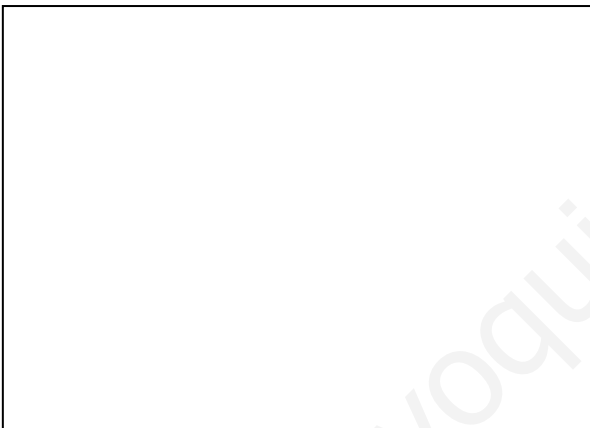

leche



coche



ducha



Escribe:



.....



.....

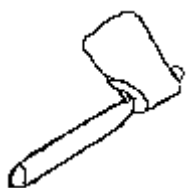

.....



.....



.....



.....

www.yoquieroaprobar.es

Copia y relaciona:

OCHO

.....



NOCHE

.....



EFE

.....



FILA

.....



FELIPE

.....



CAFE

.....



Copia y relaciona:

fila

.....



noche

.....



ocho

.....



café

.....



Felipe

.....



efe

.....



Copia y relaciona:

noche
.....



fila
.....



Felipe
.....



cafe
.....



ocho
.....



eje
.....



Relaciona:

NOCHE

ocho

noche

OCHO

noche

ocho

CAFE

efe

cafe

EFE

cafe

efe

FELIPE

fila

Felipe

FILA

Felipe

fila

Escribe:

NA

CHA

NE

CHE

NI

CHI

NO

CHO

NU

CHU



A

CHA

E

CHE

I

CHI

O

CHO

U

CHU

	CA	FA
	QUE	FE
	QUI	FI
	CO	FO
	CU	FU

	A	FA
	E	FE
	I	FI
	O	FO
	U	FU

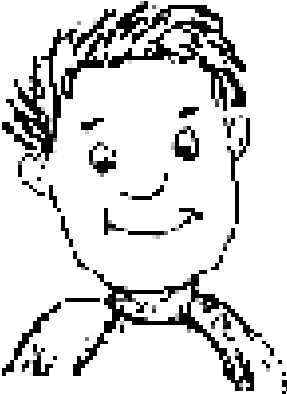
	FA	LA	PA
	FE	LE	PE
	FI	LI	PI
	FO	LO	PO
	FU	LU	PU

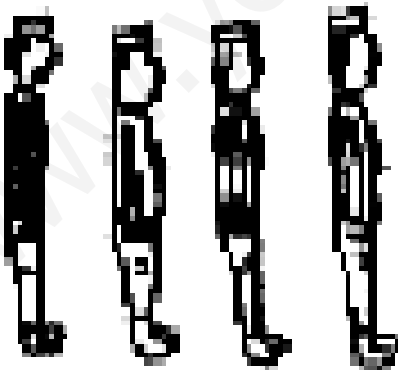
	FA	LA
	FE	LE
	FI	LI
	FO	LO
	FU	LU

Dibuja:

fila

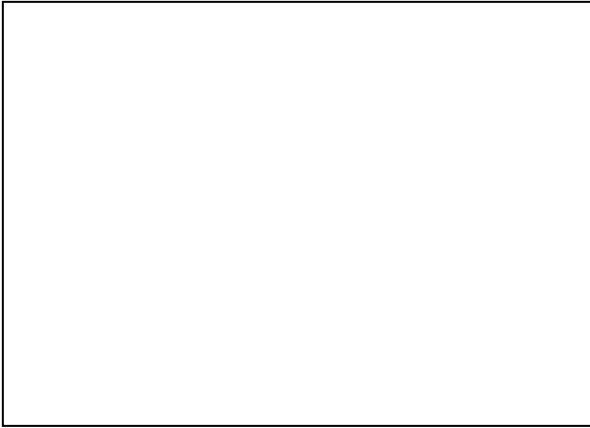

Felipe



eфе



cafe

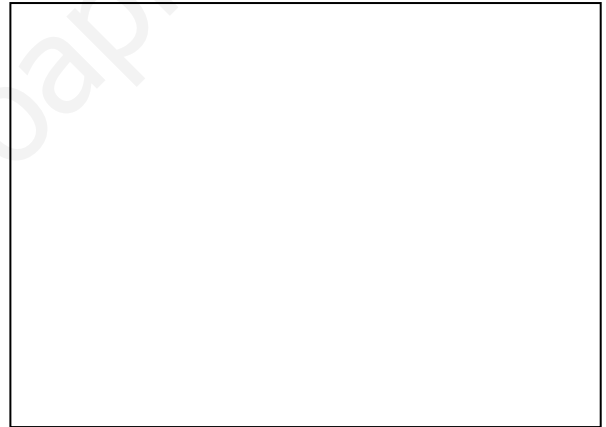

ocho



noche



Escribe:



.....



.....



.....



.....



.....



.....

www.yoquieroaprobar.es

Copia y relaciona:

FUEGO

.....



FUMA

.....



FILO

.....



FOCA

.....



FOLIO

.....



FUENTE

.....



Copia y relaciona:

foca

.....



fuelle

.....



folio

.....



filo

.....



fuego

.....



fuma

.....



Copia y relaciona:

foca

.....



fuego

.....

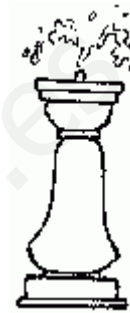

filo

.....



fuego

.....



fuma

.....



folio

.....

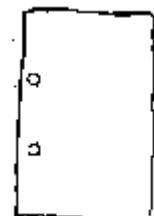

Relaciona:

FOLIO

foca

foca

FILO

folio

fuego

FUENTE

filo

folio

FUMA

fuelle

filo

FUEGO

fuma

fuelle

FOCA

fuego

fuma

Escribe:

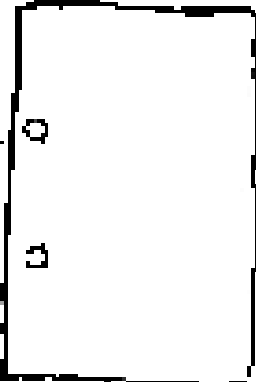
	FA	LA	A
	FE	LE	E
	FI	LI	I
	FO	LO	O
	FU	LU	U

	FA	LA
	FE	LE
	FI	LI
	FO	LO
	FU	LU



FA

MA

FE

ME

FI

MI

FO

MO

FU

MU



FA

A

GA

FE

E

GUE

FI

I

GUI

FO

O

GO

FU

U

GU

	FA	CA
	FE	QUE
	FI	QUI
	FO	CO
	FU	CU
<p style="text-align: center;">www.yoquieroaprobar.es</p>		

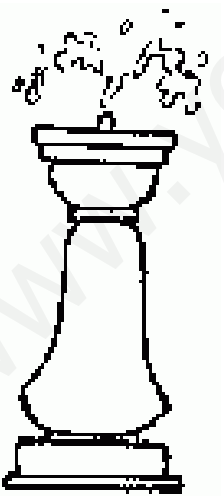
	FA	AN	TA
	FE	EN	TE
	FI	IN	TI
	FO	ON	TO
	FU	UN	TU
<p style="text-align: center;">www.yoquieroaprobar.es</p>			

Dibuja:

foca

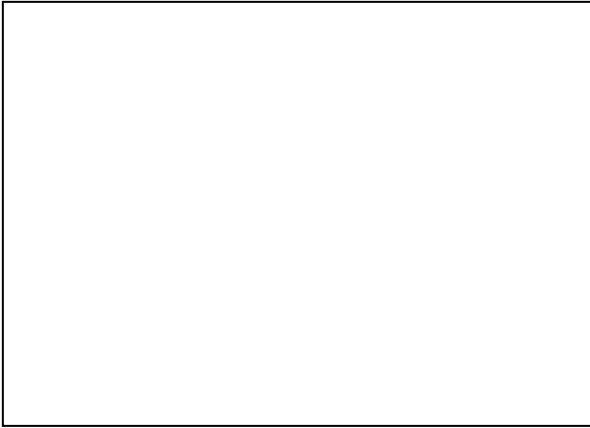

fuente



folio

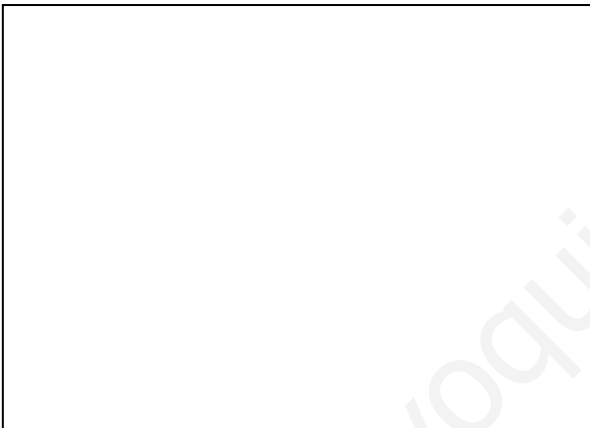

fuego



fuma



filo



Escribe:

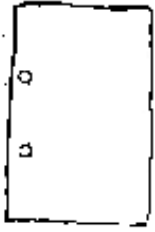

.....



.....



.....



.....

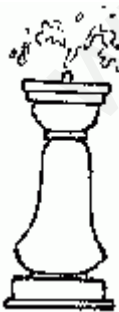

.....



.....

www.yoquieroaprobar.es

Copia y relaciona:

SOFA

.....

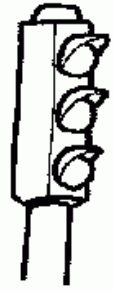

SEMAFORO

.....

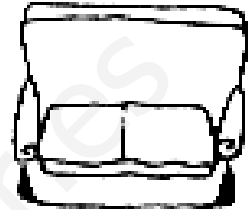

CANGURO

.....

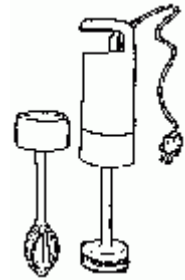

BATIDORA

.....



CORAZON

.....



CEREZA

.....



Copia y relaciona:

canguro

.....

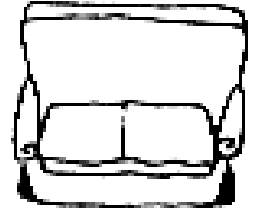

sofa

.....

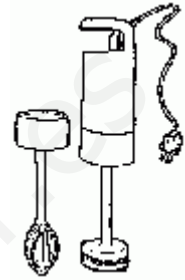

corazon

.....



semaforo

.....



cereza

.....

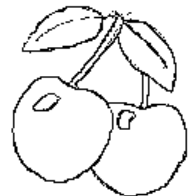

batidora

.....



Copia y relaciona:

cereza

.....



corazon

.....



batidora

.....

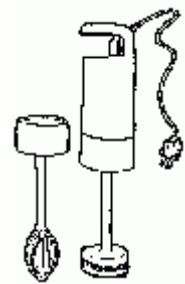

semaforo

.....



canguro

.....

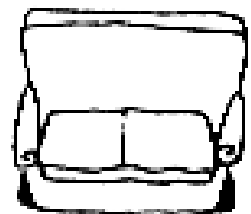

sofa

.....



Relaciona:

SOFA

semaforo

cereza

SEMAFORO

batidora

semaforo

BATIDORA

sofa

canguro

CANGURO

corazon

sofa

CEREZA

cereza

batidora

CORAZON

canguro

corazon

Escribe:

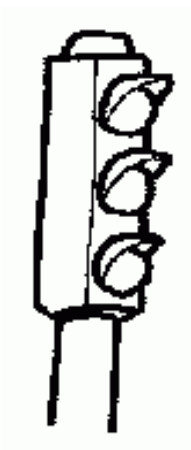
	SA	MA	FA	RA
	SE	ME	FE	RE
	SI	MI	FI	RI
	SO	MO	FO	RO
	SU	MU	FU	RU

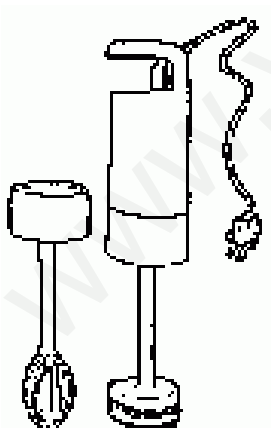
	BA	TA	DA	RA
	BE	TE	DE	RE
	BI	TI	DI	RI
	BO	TO	DO	RO
	BU	TU	DU	RU

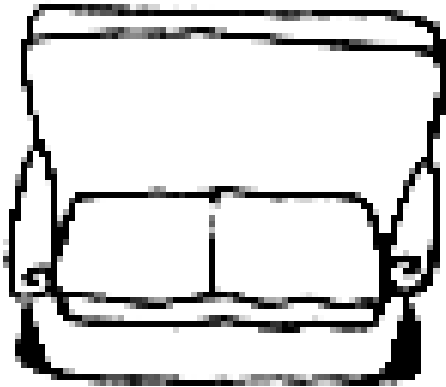

SA

FA

SE

FE

SI

FI

SO

FO

SU

FU



CAN

GA

RA

QUEN

GUE

RE

QUIN

GUI

RI

CON

GO

RO

CUN

GU

RU

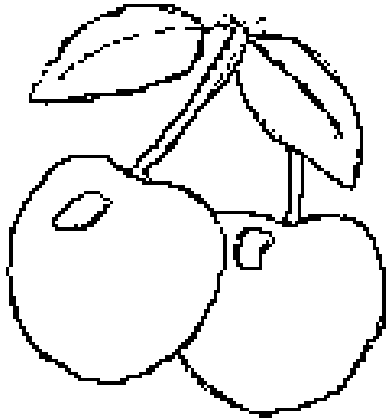

ZA

RA

ZA

CE

RE

CE

CI

RI

CI

ZO

RO

ZO

ZU

RU

ZU

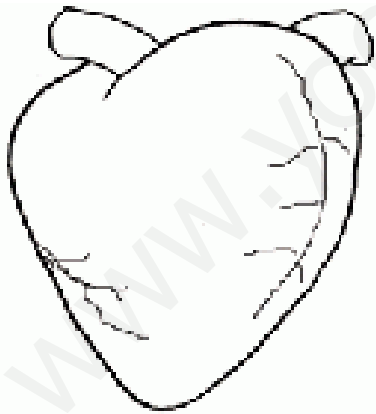

CA

RA

ZAN

QUE

RE

CEN

QUI

RI

CIN

CO

RO

ZON

CU

RU

ZUN

Dibuja:

corazon

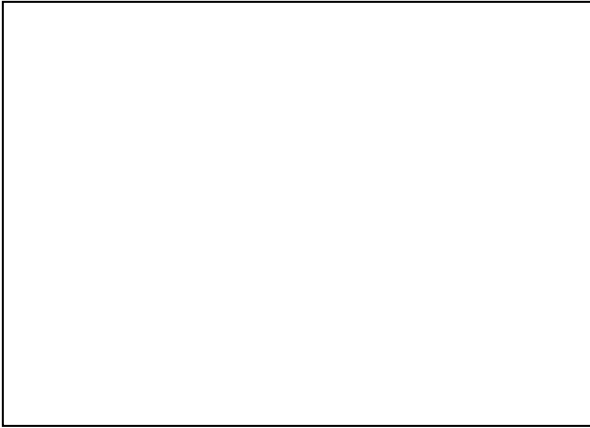

cereza



sofa



semaforo



canguro



batidora



Escribe:



.....

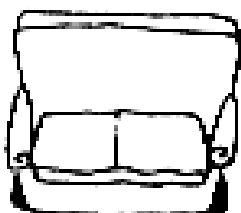

.....

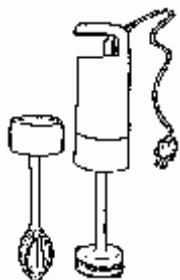

.....



.....



.....



.....

www.yoquieroaprobar.es

Copia y relaciona:

LORO

.....



MARIPOSA

.....



ROCA

.....

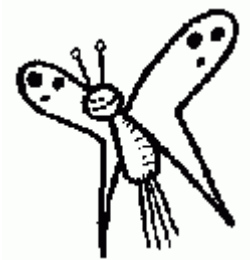

LAPICERO

.....



TIJERAS

.....



REINA

.....

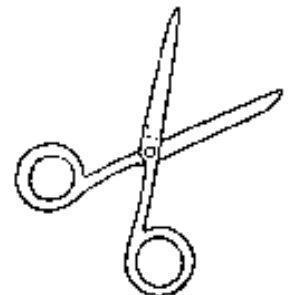

Copia y relaciona:

mariposa

.....



loro

.....



reina

.....



lapicero

.....



roca

.....

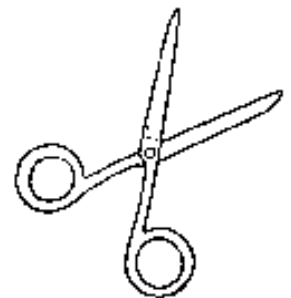

tijeras

.....



Copia y relaciona:

tijeras

.....



roca

.....

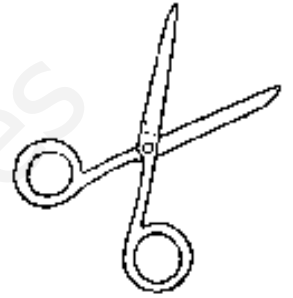

loro

.....



mariposa

.....

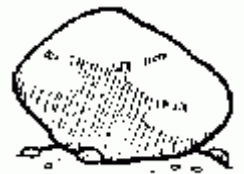

reina

.....

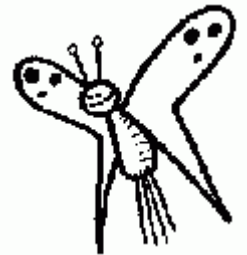

lapicero

.....



Relaciona:

LAPICERO

mariposa

mariposa

LORO

loro

tijeras

MARIPOSA

roca

lapicero

REINA

tijeras

roca

TIJERAS

lapicero

reina

ROCA

reina

loro

Escribe:

	LA	PA	ZA	RA
	LE	PE	CE	RE
	LI	PI	CI	RI
	LO	PO	ZO	RO
	LU	PU	ZU	RU

	LA	RA
	LE	RE
	LI	RI
	LO	RO
	LU	RU

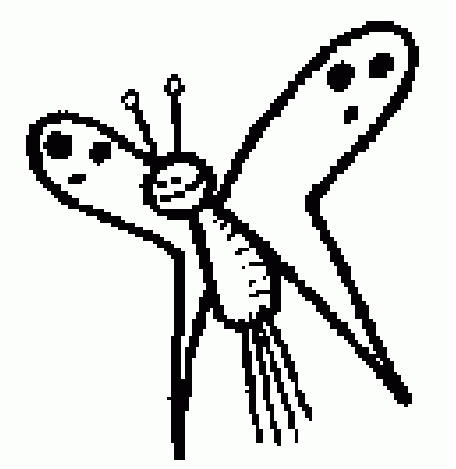

MA

RA

PA

SA

ME

RE

PE

SE

MI

RI

PI

SI

MO

RO

PO

SO

MU

RU

PU

SU



RA

A

NA

RE

E

NE

RI

I

NI

RO

O

NO

RU

U

NU



RA

CA

RE

QUE

RI

QUI

RO

CO

RU

CU

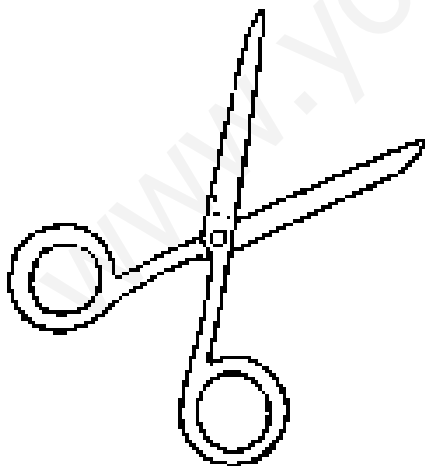

TA

JA

RAS

TE

JE

RES

TI

JI

RIS

TO

JO

ROS

TU

JU

RUS

Dibuja:

tijeras

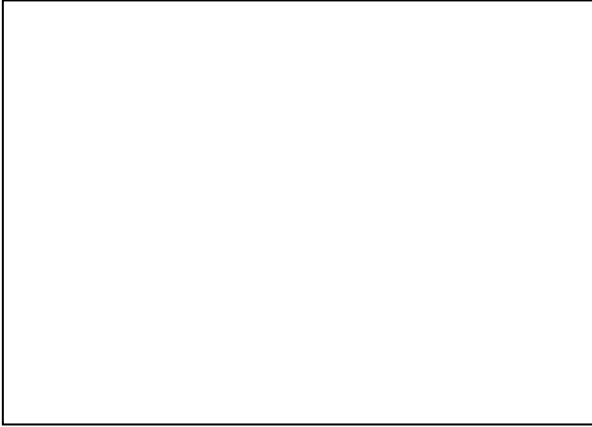

roca



reina



loro



lapicero



mariposa

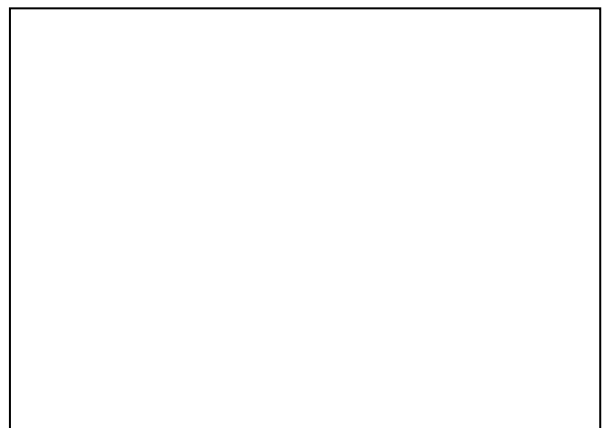

Escribe:



.....



.....

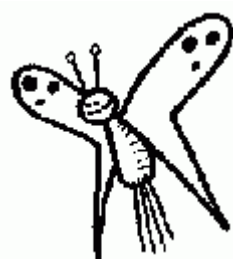

.....



.....



.....

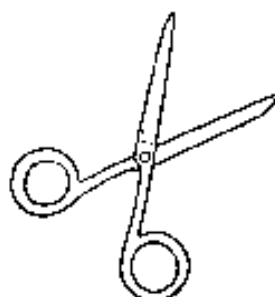

.....

www.yoquieroaprobar.es

Copia y relaciona:

CARRO

.....



BURRO

.....

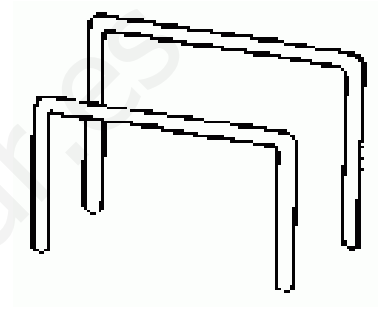

BARRACA

.....

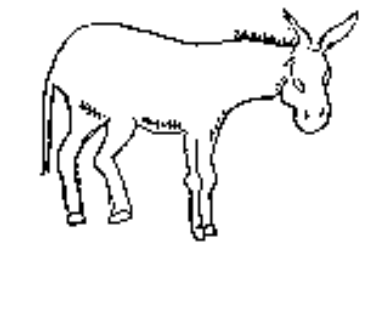

CORREDOR

.....

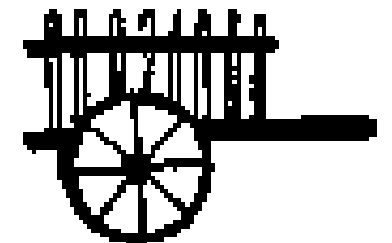

GORRA

.....



BARRAS

.....



Copia y relaciona:

barras

.....

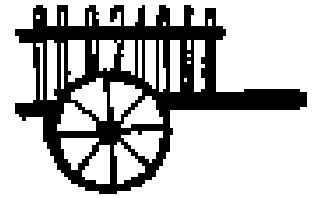

corredor

.....



barraca

.....



carro

.....

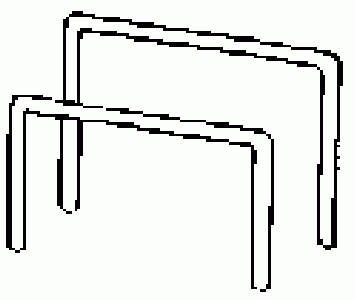

gorra

.....

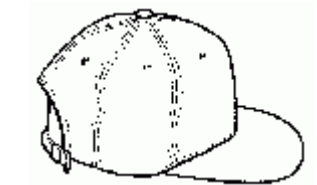

burro

.....



Copia y relaciona:

burro

.....

roca

.....

barraca

.....

carro

.....

corredor

.....

gorra

.....

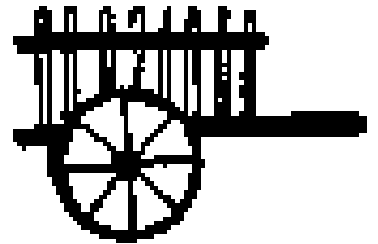
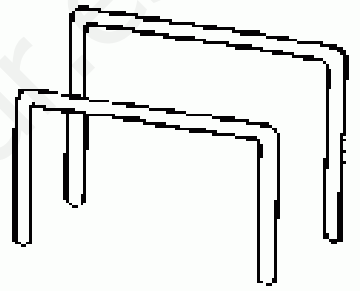

Relaciona:

BARRACA

burro

corredor

ROCA

roca

barras

BURRO

barraca

carro

CORREDOR

carro

barraca

BARRAS

corredor

burro

CARRO

barras

roca

Escribe:

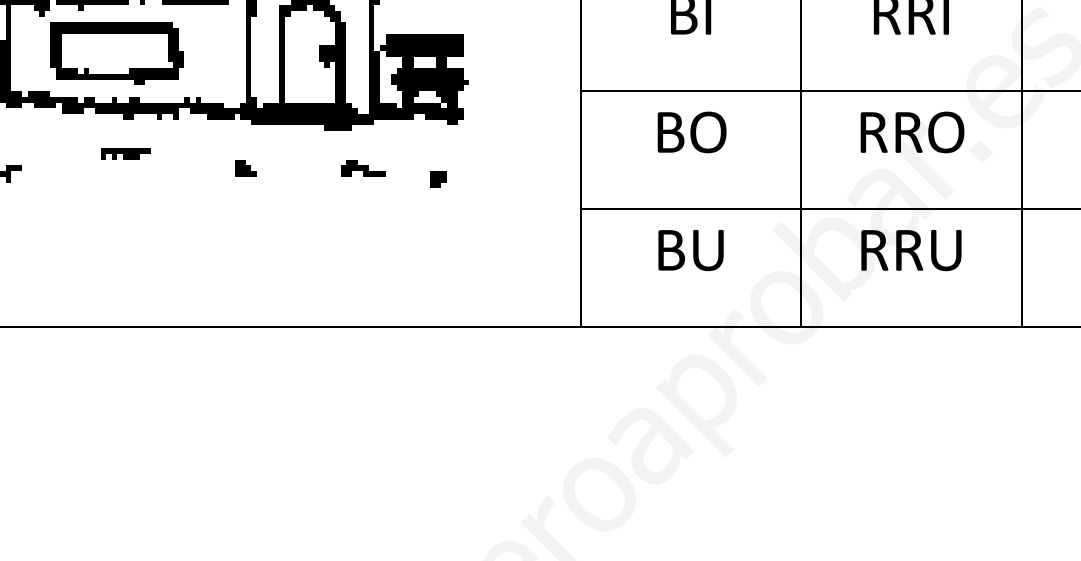
	BA	RRA	CA
	BE	RRE	QUE
	BI	RRI	QUI
	BO	RRO	CO
	BU	RRU	CU
<div style="text-align: center;">  </div>			

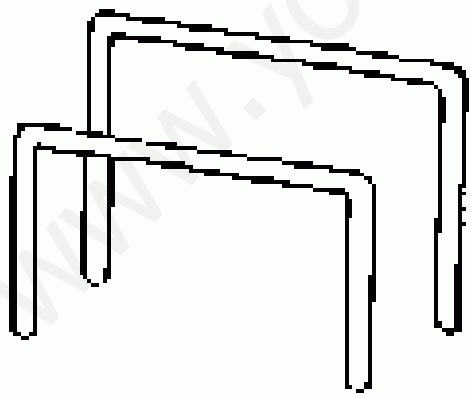
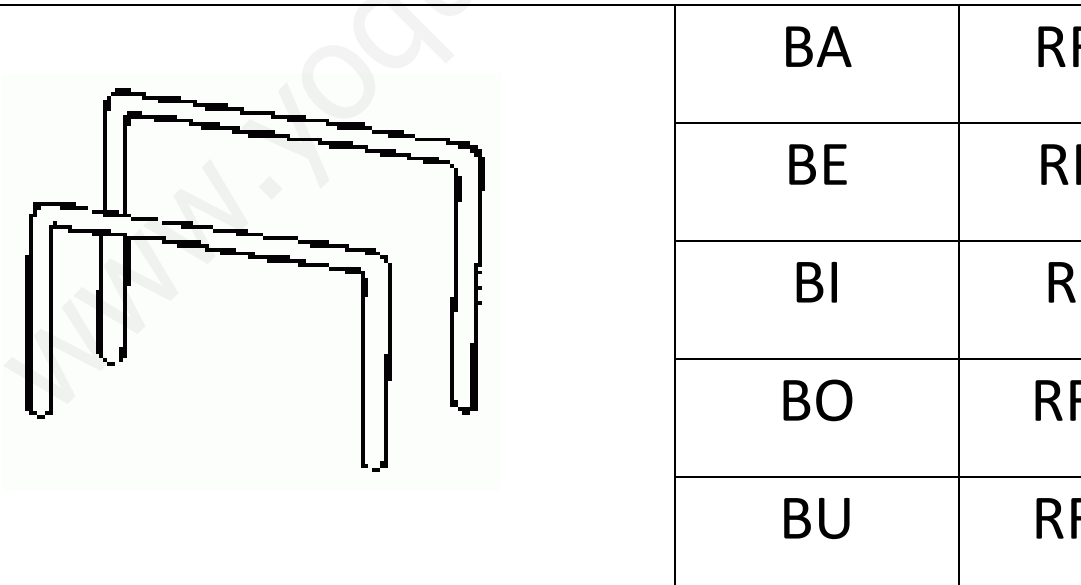
	BA	RRAS
	BE	RRES
	BI	RRIS
	BO	RROS
	BU	RRUS
<div style="text-align: center;">  </div>		

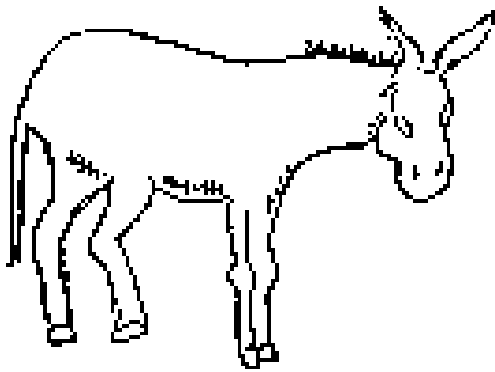

BA

RRA

BE

RRE

BI

RRI

BO

RRO

BU

RRU

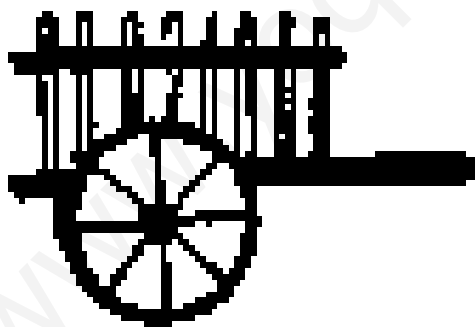

CA

RRA

QUE

RRE

QUI

RRI

CO

RRO

CU

RRU

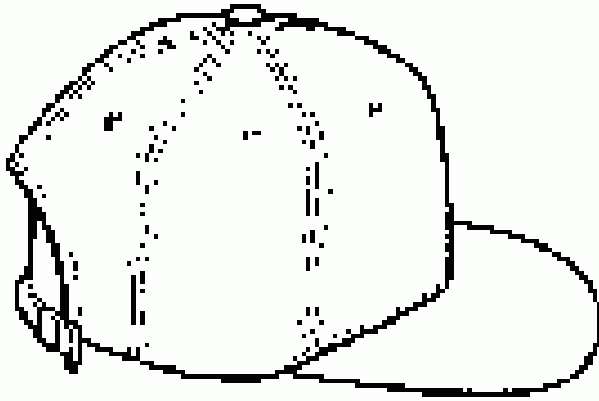

GA

RRA

GUE

RRE

GUI

RRI

GO

RRO

GU

RRU



CA

RRA

AR

QUE

RRE

DER

QUI

RRI

DIR

CO

RRO

DOR

CU

RRU

DUR

Dibuja:

gorra

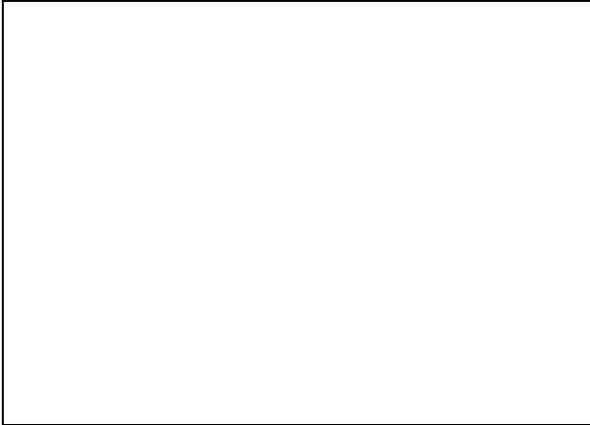

barraca



barras



carro



burro



corredor



Escribe:



.....

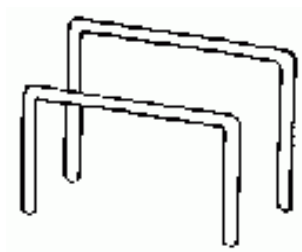

.....



.....

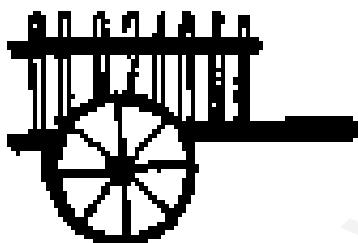

.....



.....



.....

www.yoquieroaprobar.es

Copia y relaciona:

TARRO

.....

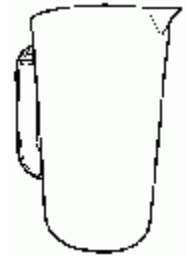

PERRO

.....

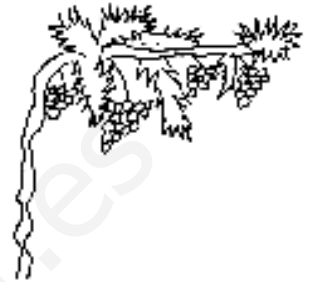

JARRA

.....

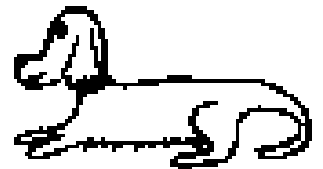

PARRA

.....



CARRUAJE

.....

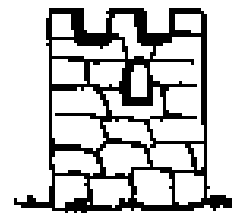

TORRE

.....

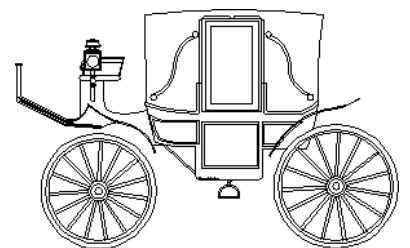

Copia y relaciona:

torre

.....



perro

.....

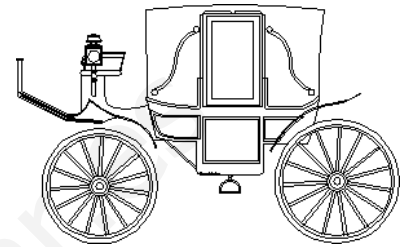

carruaje

.....



tarro

.....

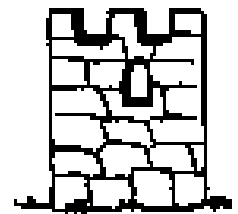

parra

.....

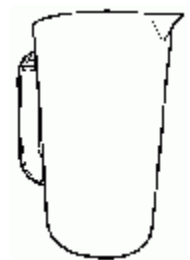

jarra

.....



Copia y relaciona:

tarro

.....

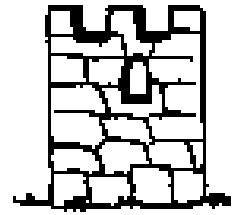

torre

.....



perro

.....

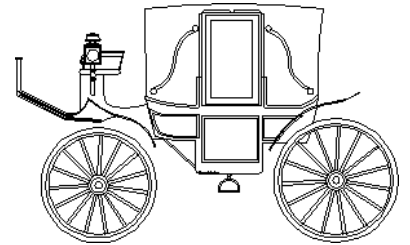

carruaje

.....

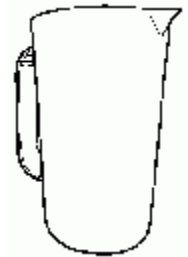

parra

.....



jarra

.....



Relaciona:

JARRA

parra

parra

PARRA

jarra

jarra

TORRE

carruaje

perro

TARRO

perro

torre

CARRUAJE

torre

tarro

PERRO

tarro

carruaje

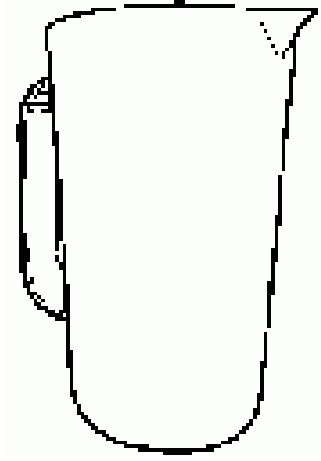
Escribe:

JA

RRA

JE

RRE

JI

RRI

JO

RRO

JU

RRU

PA

RRA

PE

RRE

PI

RRI

PO

RRO

PU

RRU

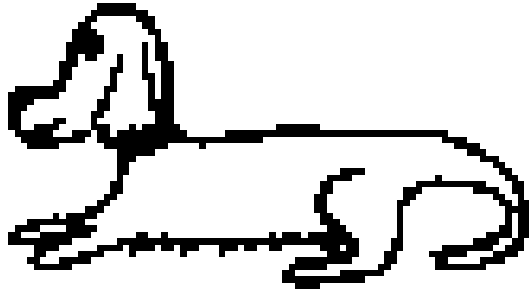

PA

RRA

PE

RRE

PI

RRI

PO

RRO

PU

RRU

TA

RRA

TE

RRE

TI

RRI

TO

RRO

TU

RRU

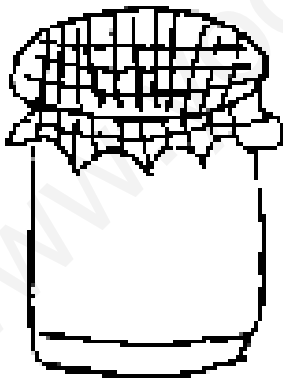

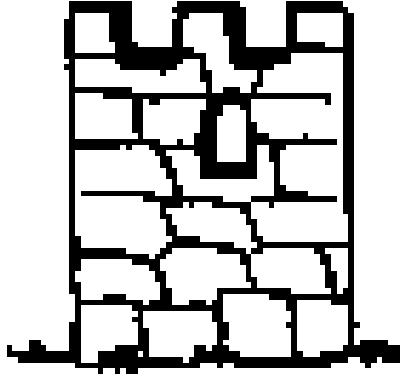

TA

RRA

TE

RRE

TI

RRI

TO

RRO

TU

RRU

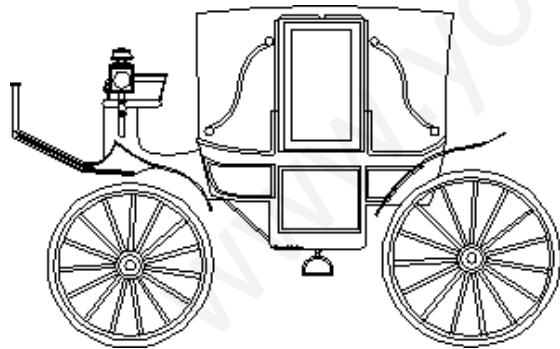

CA

RRA

A

JA

QUE

RRE

E

JE

QUI

RRI

I

JI

CO

RRO

O

JO

CU

RRU

U

JU

Dibuja:

parra

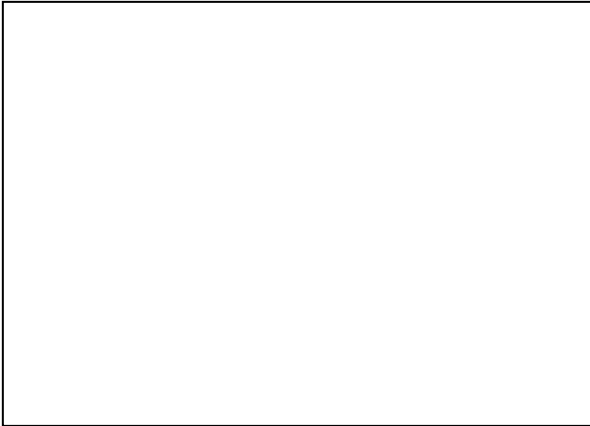

jarra



carruaje

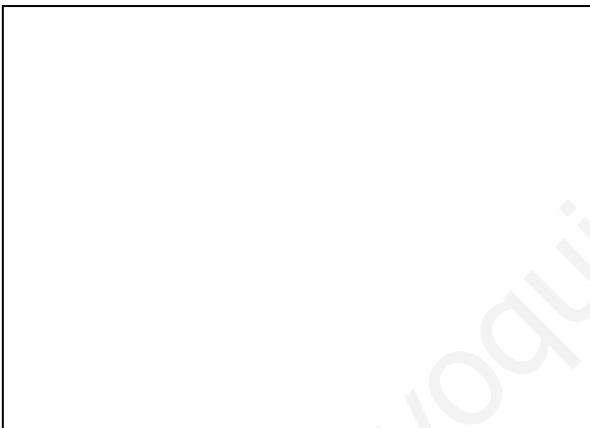

perro



torre



tarro



Escribe:

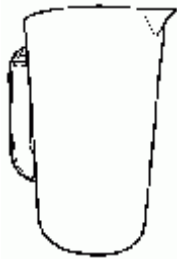

.....



.....



.....



.....

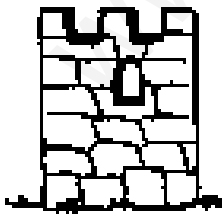

.....

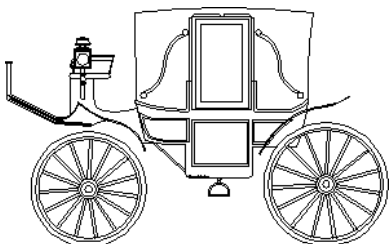

.....

www.yoquieroaprobar.es