

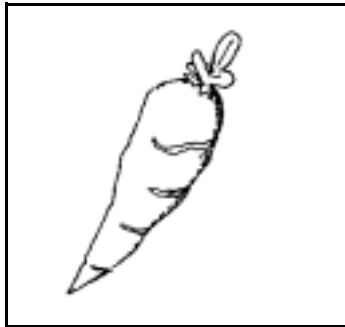

za zo zu

az ez iz oz uz



zanahoria

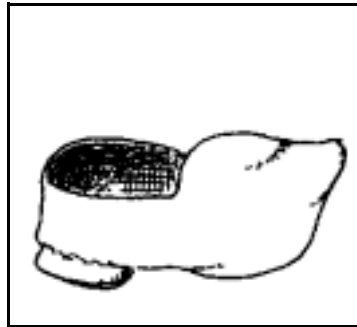

zueco

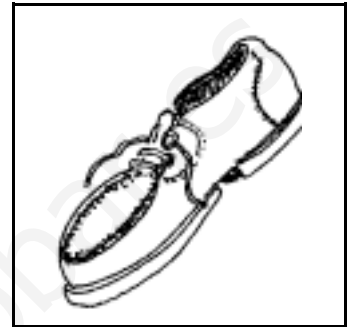

zapato

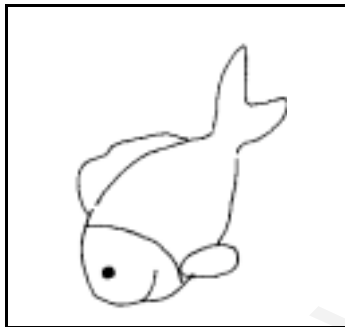

pez

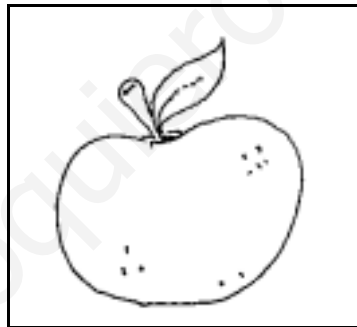

manzana

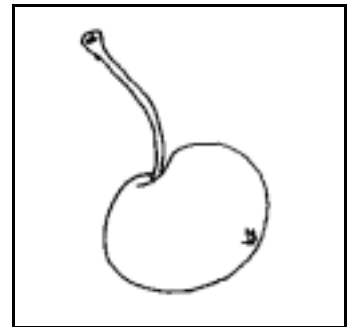

cereza



zambomba



zumo

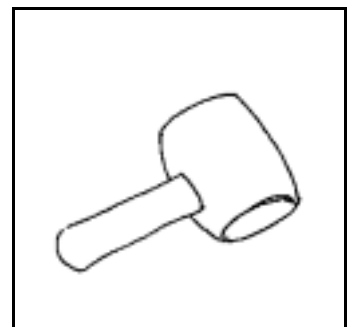

mazo

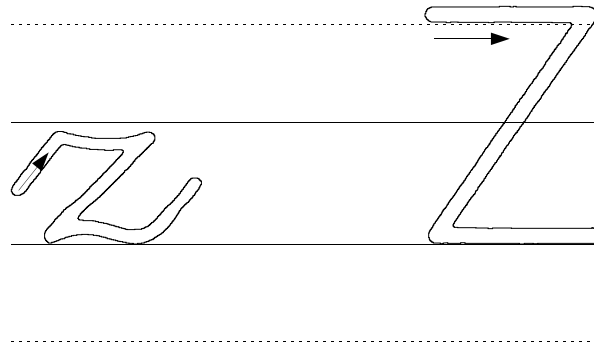

za zo zu Za Zo Zu
az ez iz ez uz

zambonía zueco zapato pez
manzana cereza mazapán
zambomba zumo mazo lazo
azul anuelo raíz zoco

El zapato tiene un lazo.
Un manzano con manzanas.
El cerro bebe agua en el río.
Tengo un pastel de cerezas.
Este lápiz es de color azul.
La taza de café está caliente.
El buzo sale del agua.



Za Ze Zu

za ze zu

El agua está en el pozo

Como un helado de cerezas

Desayuno zumo de naranjas

El cielo es de color azul

La azteca está arriba

Nadia tiene un lazo en el pelo

Dame esa taza de café

Mamá sale a la terraza



Yi toma zumo de naranjas.

¿Qué toma Yi?

Este zapato me queda pequeño.

¿Cómo te queda el zapato?

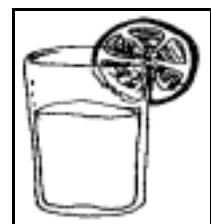
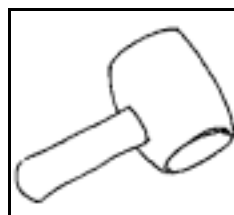
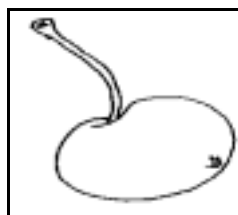
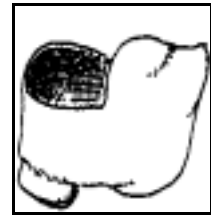

el pez
 la manzana
 el zueco
 el maíz
 el zapato
 la zanahoria
 la cereza
 el mazo
 el zumo
 la zambomba



manzana

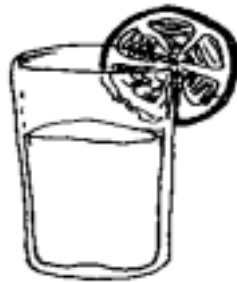

zumo



mazo



anzuelo



maíz



lazo



zanahoria



pez



zapato



Este zapato me queda pequeño

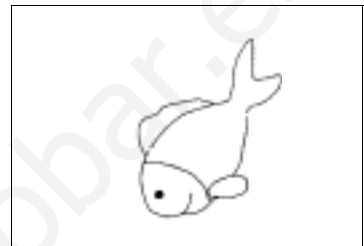

El pez nada en el estanque

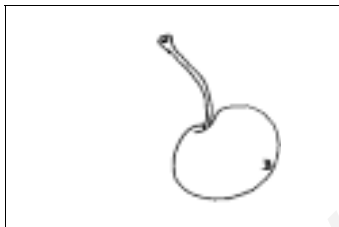

Me como una tarta de cerezas



Desayuno zumo de naranjas



Escribe un o una

un albormoz	_____ terraza
una luz	_____ mozo
_____ yate	_____ taza
_____ yogur	_____ lápiz
_____ rayo	_____ zorro
_____ mayonesa	_____ manzana
_____ camión	_____ buzo
_____ pez	_____ lazo
_____ zumo	_____ cereza

~~cielo~~ zorro choza ceja pozo cerrojo
buzo cocido zapato ciego

ce ci
cielo

za zo zu



 <p>Leo...</p>	<p>El pez Azulín</p>	
		
<p>Azulín es un pez pequeñito</p>	<p>Es de color azul celeste</p>	<p>Nada en el río con su familia</p>
		
<p>Quiero salir del agua, mamá</p>	<p>No puedes, Azulín</p>	<p>¡Cuidado con el anzuelo!</p>

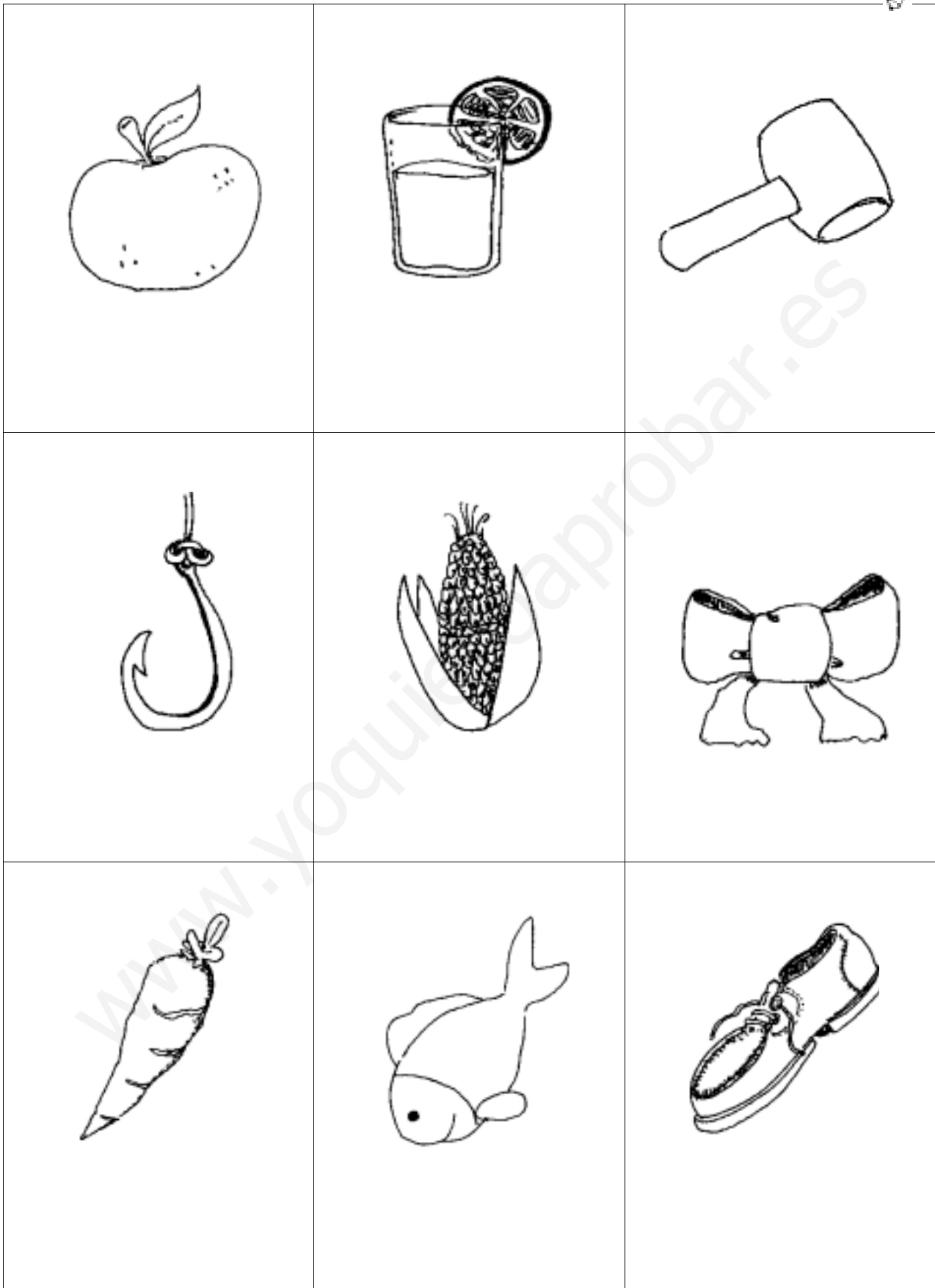



Yi come  con la ensalada

Como  y 

El  escapa del 

Me gusta el  de 

Hace un  a su 



El zapato tiene un lazo.
Un manzano con manzanas.
El zorro bebe agua en el rio.
Tengo un pastel de cerezas.
Los zuecos son zapatos de madera
La taza de café está caliente.
El buzo sale del agua.
Este lápiz es de color azul.



Handwriting practice lines with a watermark: www.yoquieroaprobar.es



Tema 25

第二十五课

Unit 25

El pez Azulín.	小鱼阿祖林	Azulín the fish.
Azulín es un pez pequeño.	阿祖林是一条小鱼	Azulín is a little fish.
Es de color azul celeste.	他是天蓝色的	He is sky-blue.
Nada en el río con su familia.	他在河里跟他的家人一起游	He swims in the river with his family.
Quiero salir del agua, mamá.	我要走出水,妈妈	Mummy, I want to go out from water.
No puedes, Azulín.	你不可以的,阿祖林	You can't, Azulín.
¡Cuidado con el anzuelo!	小心鱼钩	Look out for the hook!



El zapato tiene un lazo.	鞋上有一条蝴蝶结	The shoe has a ribbon.
Un manzano con manzanas.	一棵苹果树有苹果	An apple tree with some apples on it.
El zorro bebe agua en el río.	狐狸在河里喝水	The fox drinks some water at the river.
Tengo un pastel de cerezas.	我有一各樱桃蛋糕	I have a cherry cake.
Los zuecos son zapatos de madera.	木头做的鞋子	Clogs are wooden shoes.
La taza de café está caliente.	咖啡杯里的咖啡还热的.	The cup of coffee is hot.
El buzo sale del agua.	潜水员从水里出来.	The diver is coming out from water.
Este lápiz es de color azul.	这支笔是蓝色的.	This pencil is blue.