

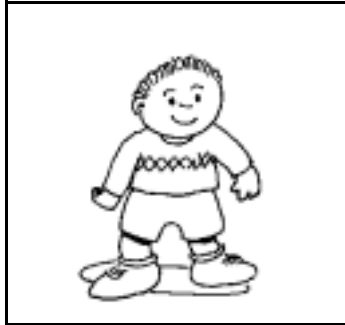

ña ne ni no nu

ñ Ñ



niño

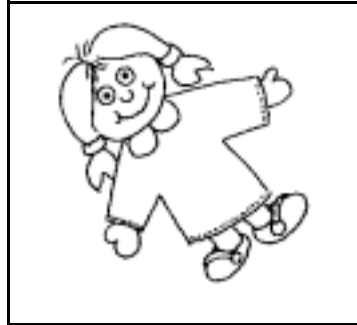

muñeca

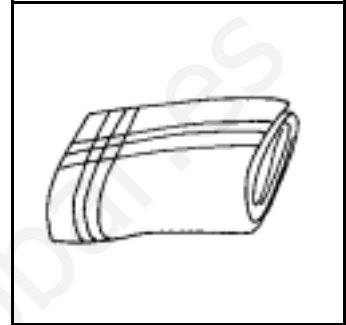

pañuelo

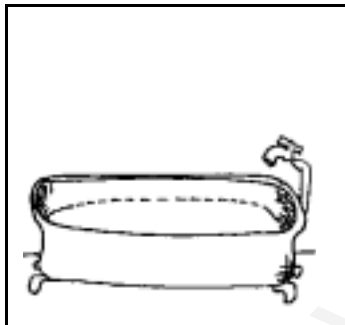

bañera

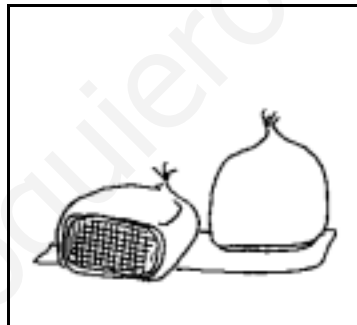

castañas

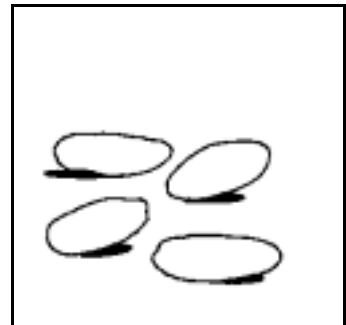

piñones



uña



cabaña

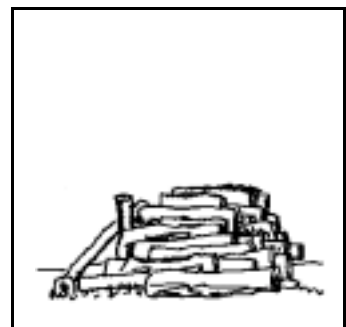

leña

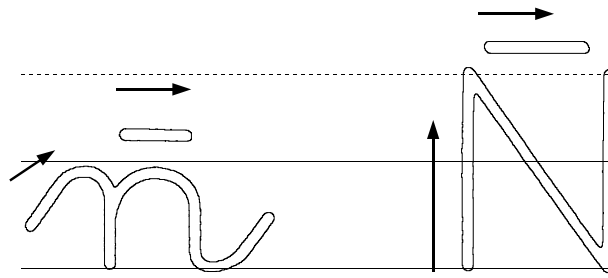

na ne ni ñe nu  
Na Ne Ni Ñe Nu

niño pañuelo muñeca ñu  
castaña bañera cabaña uña  
niña muñeco leña leñador  
muñeco muñequera bañador  
piña piñones pañoleta paño

Fátima se pone el pañuelo.  
Miguel se mete en la cabaña.  
Papá echa leña al fuego.  
Me duele la uña.  
Pongo el bañador al muñeco.  
Los niños juegan al cerro.



Na Ne Ni No Nu

na ne ni no nu

Las niñas juegan en la arena

La muñeca de Teñi es bonita

Fátima se pone la pañolera

Como castañas y piñones

Papá pone mucha leña

Me pongo el bañador rojo

Berta juega con su muñeco

El leñador cuida el abeto



Toñi tiene una muñeca.

¿Qué tiene Toñi?

La muñeca tiene un babi rojo.

¿Qué tiene la muñeca?

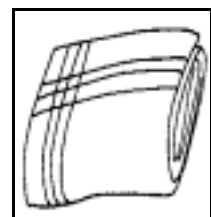
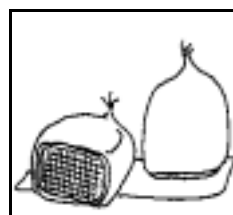
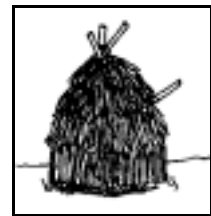
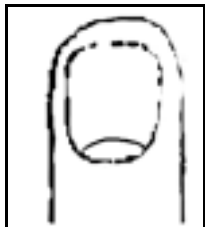

Toñi  
 la niña  
 los piñones  
 la cabaña  
 la uña  
 el pañuelo  
 la muñeca  
 las castañas  
 la leña  
 el niño



muñeca



Teti



caña

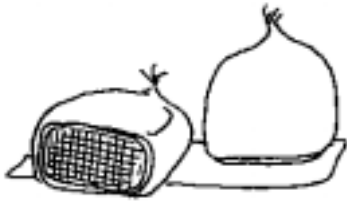

castañas



piñones



urina



bañera



nino

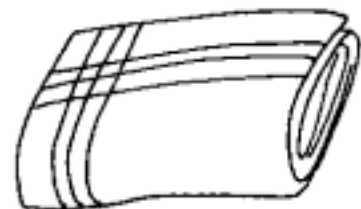

pañuelo



Toñi juega con su muñeca

.....

\_\_\_\_\_

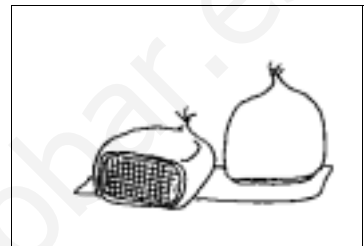

Como castañas y piñones

.....

\_\_\_\_\_



La niña juega con el balón

.....

\_\_\_\_\_



El bati de la muñeca es rojo

.....

\_\_\_\_\_



Delante de r y l ponemos m

|           |          |
|-----------|----------|
| bombón    | bombón   |
| bombero   | bo__bero |
| compás    | co__pás  |
| campana   | ca__pana |
| pampa     | pa__pa   |
| campo     | ca       |
| bambalina | ba       |
| gamba     |          |
| cambiar   |          |

~~n~~ niño nena Toñi leña bueno  
bañera cuna año nube tuno

| ñ    |
|------|
| niño |
|      |
|      |
|      |
|      |

| n |
|---|
|   |
|   |
|   |
|   |
|   |



|   |  |   |
|---|--|---|
|  <p>Leo...</p> | <p>La muñeca<br/>de Toñi</p>   |    |
|                |     |    |
| <p>Toñi tiene una<br/>muñeca. La<br/>quiere mucho</p>   | <p>Todos los días la<br/>baña en la<br/>bañera</p>                                   | <p>Luego le corta<br/>las uñas y la<br/>peina</p>                                     |
|              |  |  |
| <p>Le pone un babi<br/>de paño rojo</p>   | <p>Luego le da de<br/>comer:<br/>despacio o te<br/>hará daño</p>                     | <p>Ahora a dormir,<br/>que tienes mucho<br/>sueño.</p>                                |



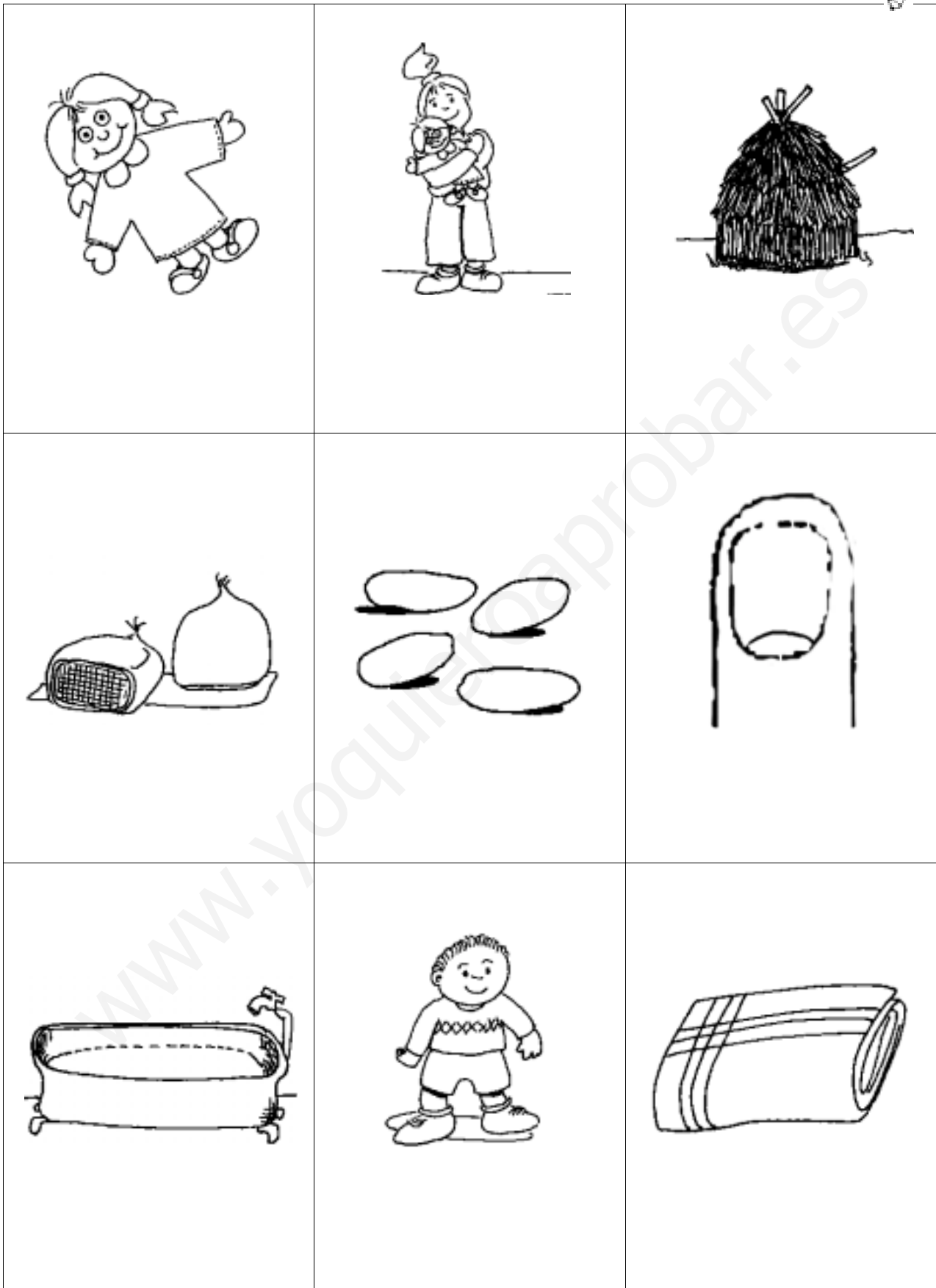



Toñi juega con su



Como



y



La



juega en la arena

La



de la muñeca es roja

Papá pone



en el fuego



Toñi juega con su muñeca.  
Los niños juegan en la arena.  
El bali de la muñeca es rojo.  
Berta come castañas y piñones.  
Fátima se pone el pañuelo en el pelo.  
Toñi cuida la bañera y el bali de la muñeca.  
Papá pone leña en el fuego para que no se apague.



Handwriting practice lines with a watermark: www.yoquieroaprobar.es



| Tema 23   | 第二十三课        | Unit 23   |
|---|--------------|---|
| La muñeca de Toñi.  | 托尼的娃娃。       | Toñi's doll.  |
| Toñi tiene una muñeca. La quiere mucho.   | 托尼有一个娃娃。他很爱  | Toñi has a doll. She loves her a lot.                             |
| Todos los días la baña en la bañera.  | 每天在浴缸里给它洗澡。  | She gives her a bath every-day.                                   |
| Luego le corta las uñas y la peina.   | 然后她给它剪指甲，给她梳 | After it, she cut her nails and combs her hair.                   |
| Le pone un babi de paño rojo.   | 她给娃娃穿上红色的罩衫  | She puts her on a red wollen cloth overall.                       |
| Le da de comer: despacio o te hará daño.  | 然后喂它吃饭：慢点，否则 | She feeds her: "if you don't eat slowly, it will hurt you"        |
| Ahora a dormir, que tienes mucho sueño.   | 现在睡觉，你很困了。   | Go to bed now, as you are very sleepy.                            |
|  |              |   |
| Toñi juega con la muñeca.   | 托尼跟娃娃一起玩。    | Toñi is playing with the doll.                                    |
| Los niños juegan en la arena.   | 孩子们玩沙子。      | The children are playing on the sand.                             |
| El babi de la muñeca es rojo.   | 娃娃的罩衫是红色的。   | The overall of the doll is red.                                   |
| Berta come castañas y piñones.  | 贝尔塔吃栗子和松子。   | Berta is eating some chestnuts and pine nuts.                     |
| Fátima se pone el pañuelo en el pelo.   | 法提玛戴上了围巾。    | Fátima puts a headscarf on.                                       |
| Toñi cuida la bañera y el babi de la muñeca.  | 托尼小心使用浴缸和娃娃的 | Toñi takes care of the bath and the overall of the doll.          |
| Papá pone la leña en el fuego para que no se apague.                                | 爸爸把木柴放在火里使火不 | Dad is throwing some wood into the fire so that it doesn't go out |