

# **PRESENTACIÓN**

**El cuaderno de lecto-escritura ha sido elaborado como un apoyo al proceso de enseñanza-aprendizaje que usted inicia y que deseamos concluya con éxito.**

**Su contenido tiene una serie de ejercicios de aprestamiento previos al aprendizaje de las vocales, luego siguen las consonantes para la formación de sílabas directas; las biconsonantes y finalmente las sílabas biconsonantes con vocal al final.**

**También se incluyen ejercicios de lectura y escritura que le ayudarán a desarrollar habilidad y comprensión en la lectura, mejorar su expresión oral y el dominio de la escritura.**

**Con entusiasmo, dedicación y esfuerzo logrará concluir esta fase y seguir adelante en este camino que nunca es tarde emprender.**

**Adelante y buena suerte**

# OBJETIVOS

## GENERALES

- **Lograr el conocimiento y dominio del lenguaje escrito para aplicarlo en su vida cotidiana.**
- **Coadyuvar al mejoramiento del nivel de vida de los y las participantes mediante el desarrollo de las habilidades de lecto-escritura.**

## ESPECÍFICOS

- **Realizar una serie de ejercicios de aprestamiento para desarrollar la psicomotricidad fina.**
- **Ejercitar el trazo de vocales y consonantes.**
- **Fomentar y desarrollar una lectura comprensiva y una escritura creativa.**

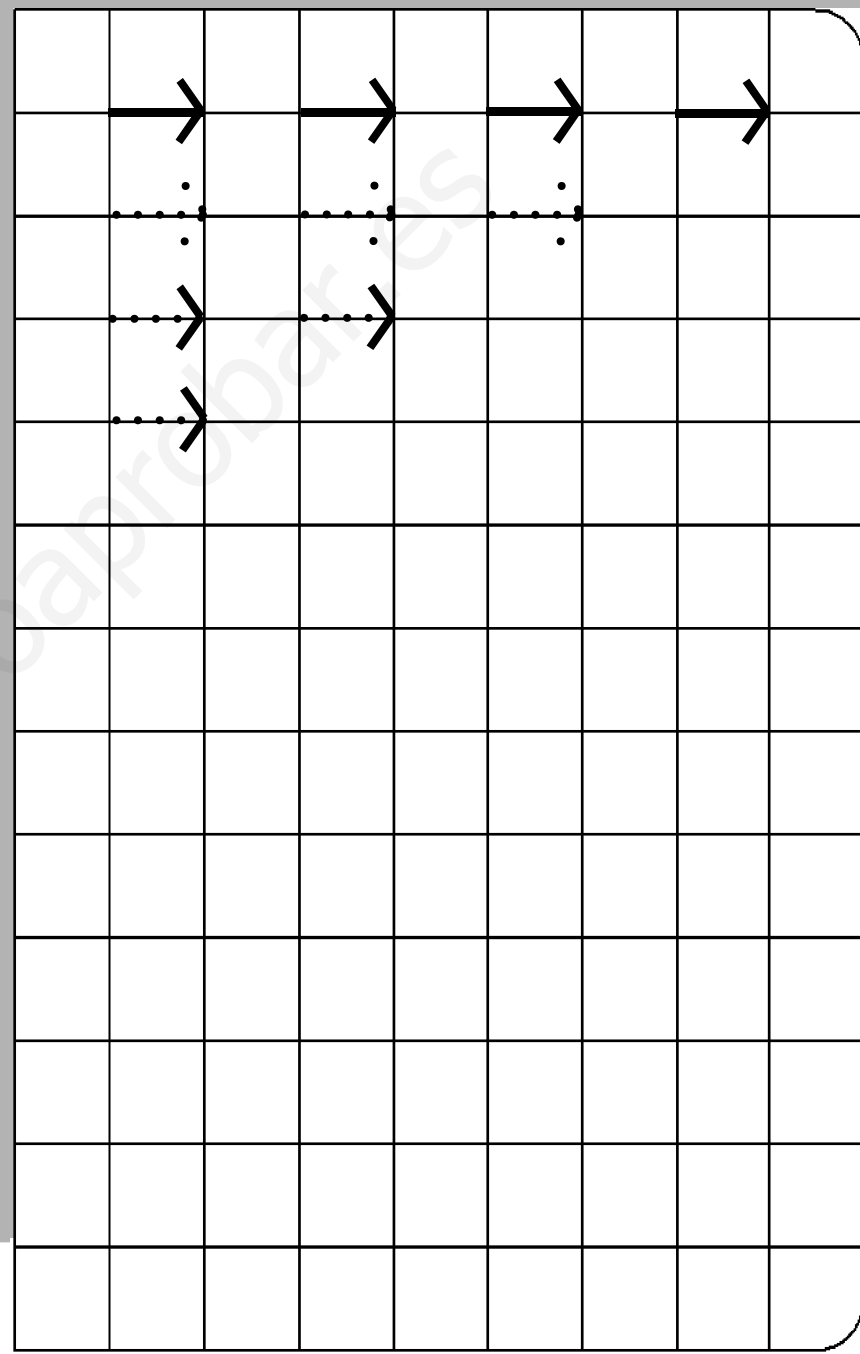
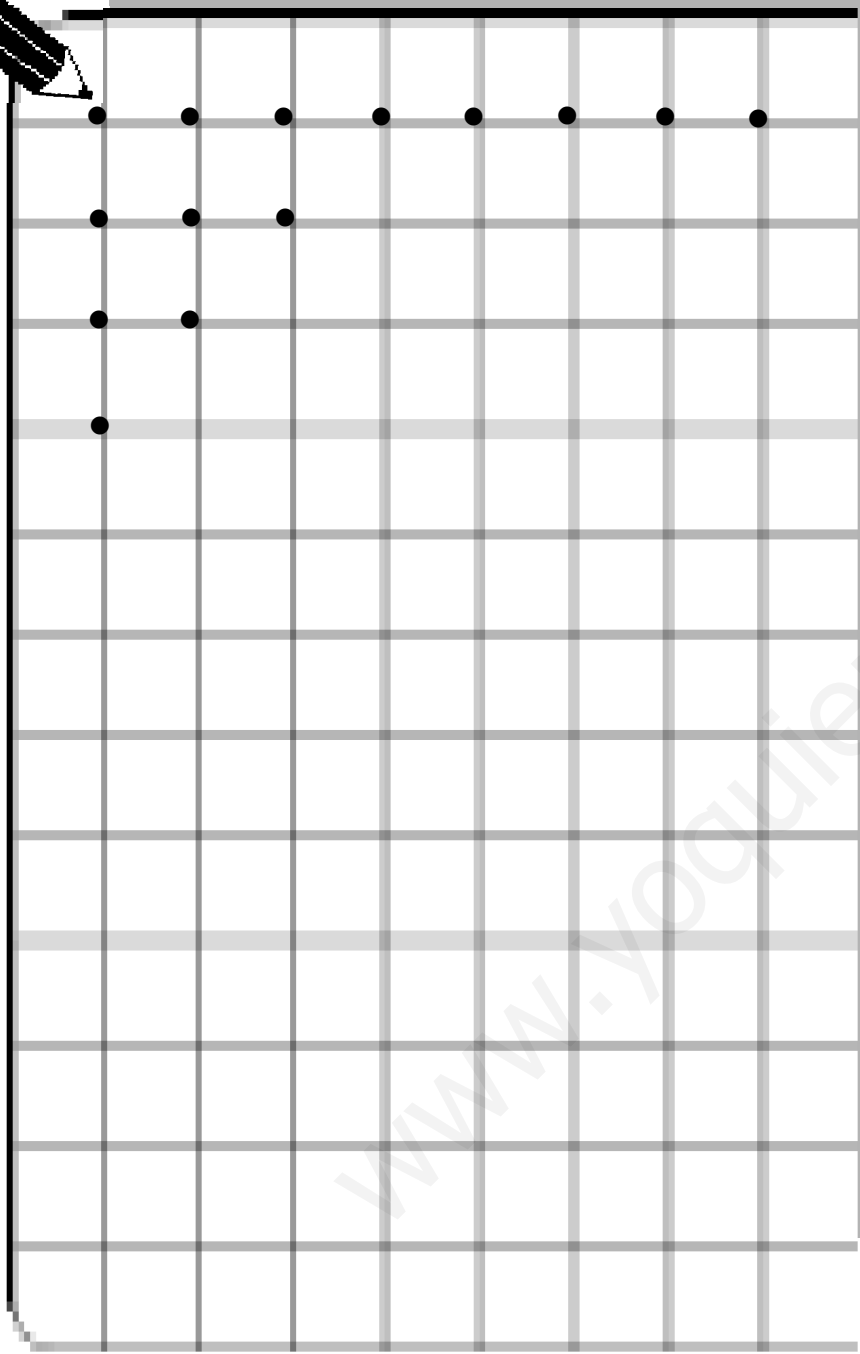

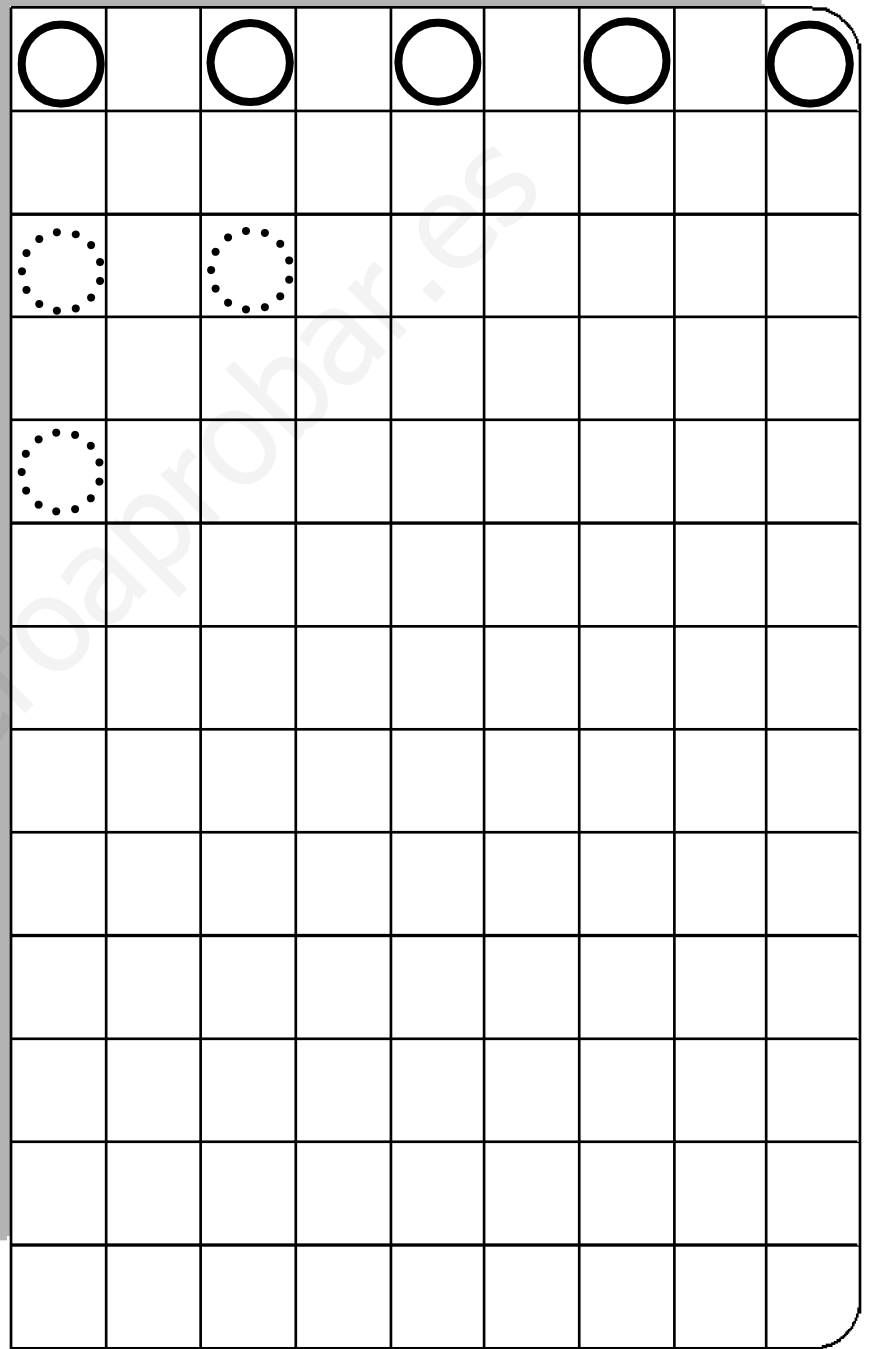
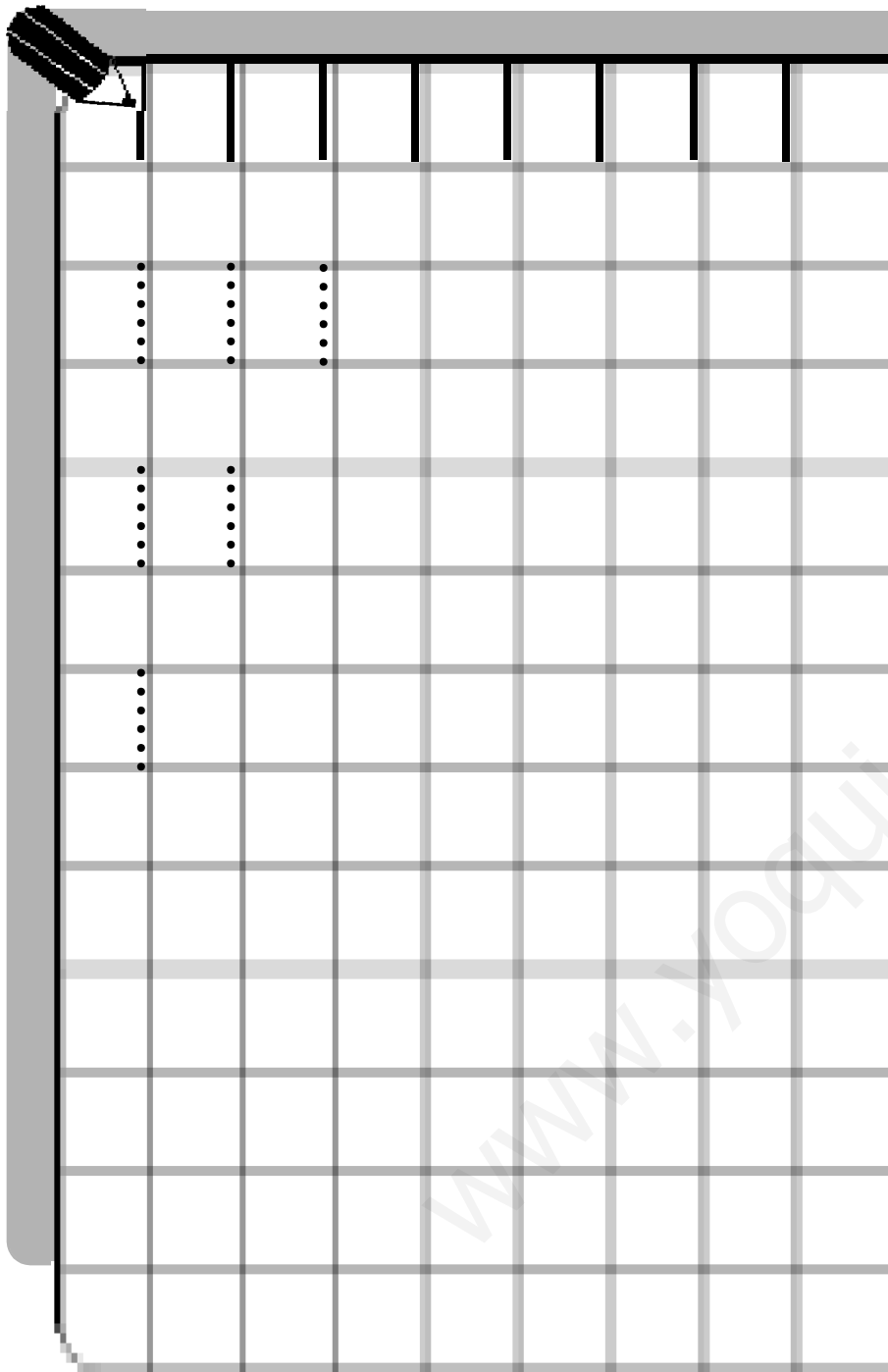

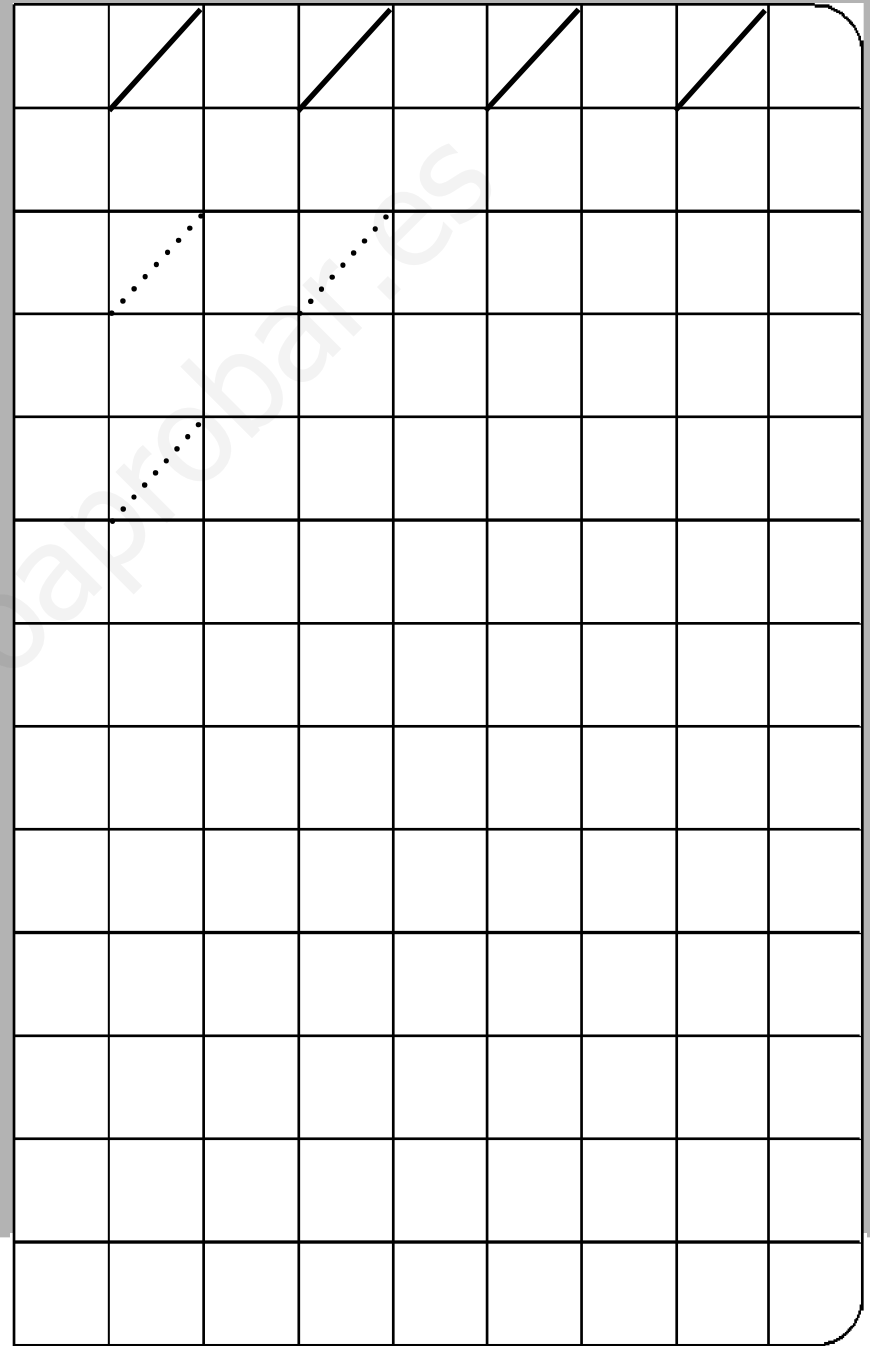
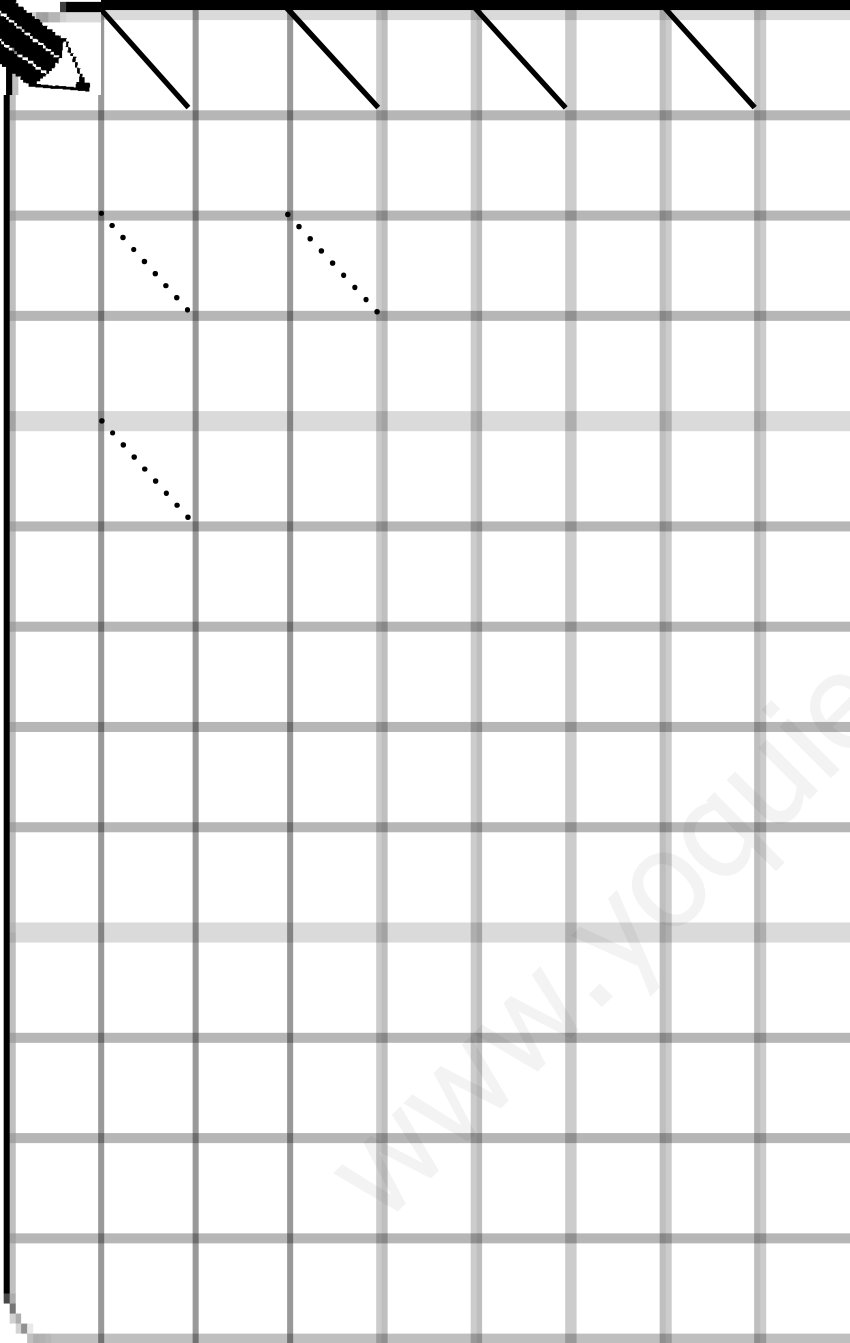



X	X	X	X				
X	X						
X							

	U	U	U	U			
	U	U					
	U						







	⌣	⌣	⌣	⌣						
	⋯	⋯								
	⋯									

	⌣	⌣	⌣	⌣						
	⋯	⋯								
	⋯									







iglesia

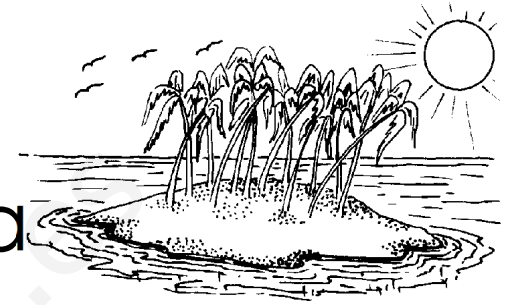

isla

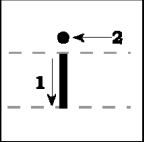
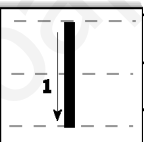
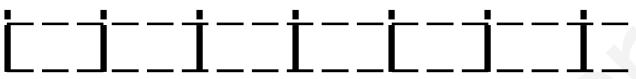

iguana

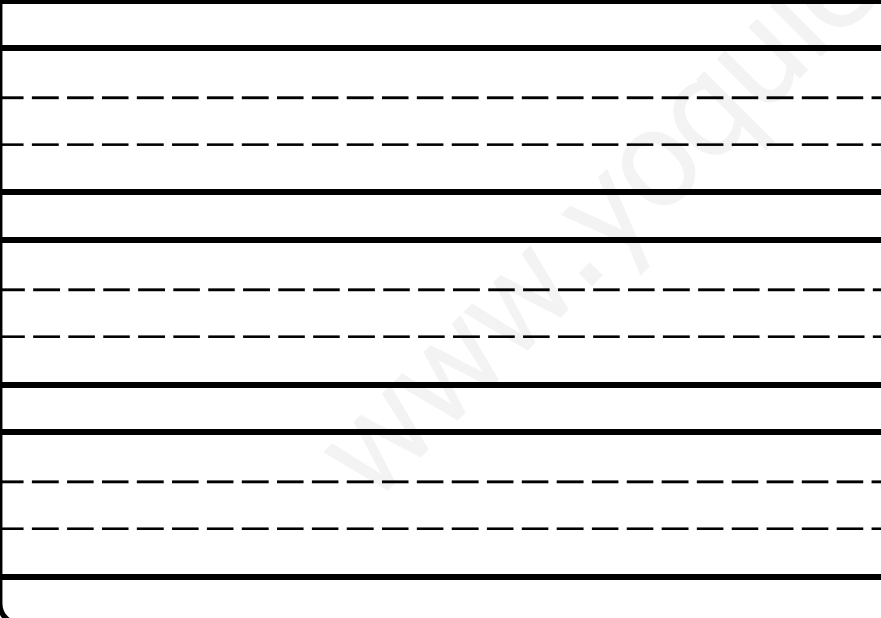
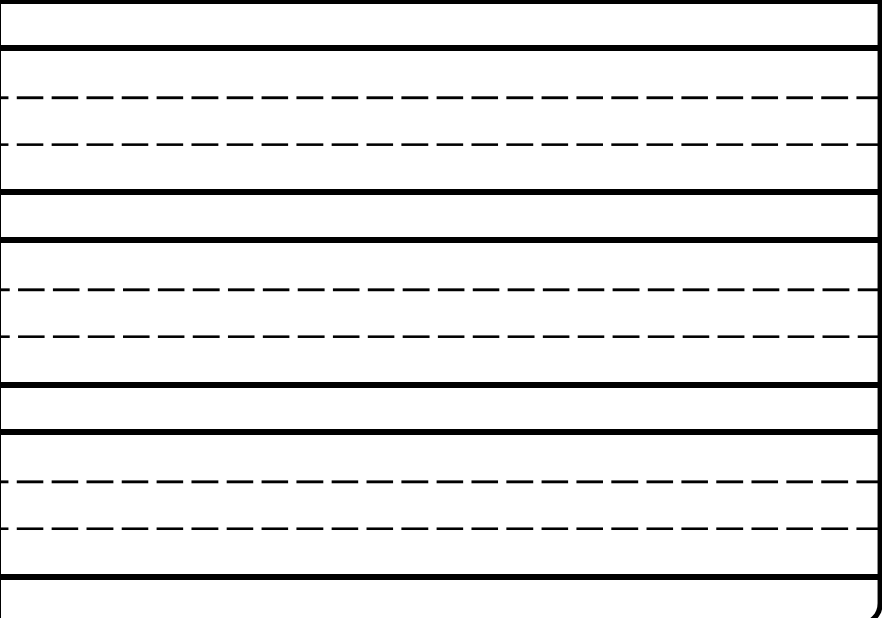

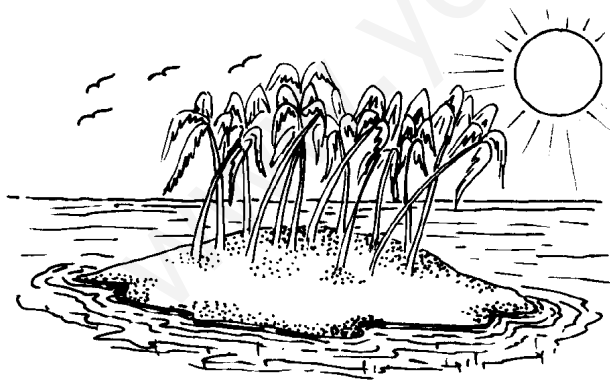
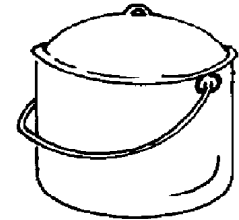
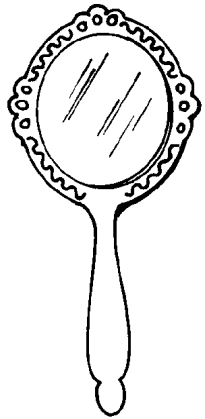
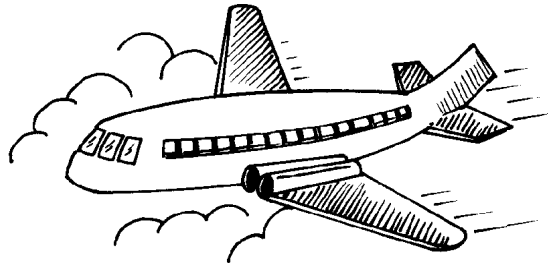
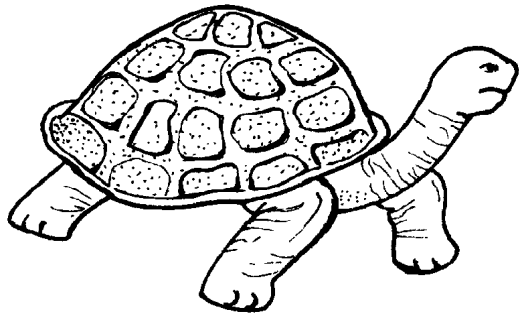

oveja

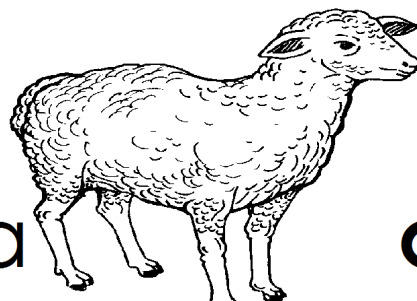

oso



oreja



olla

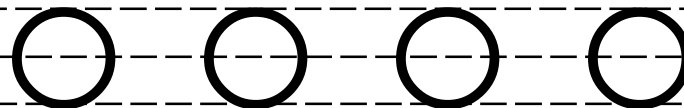
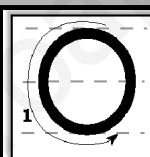
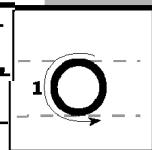

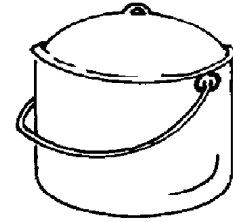
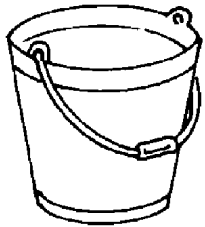
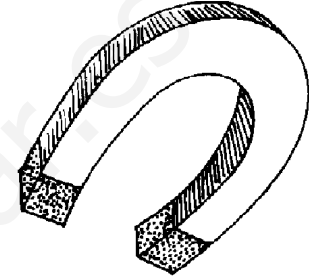
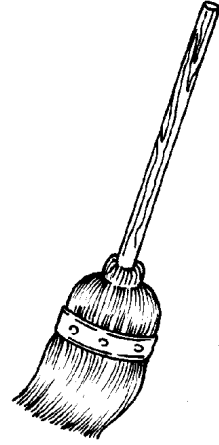
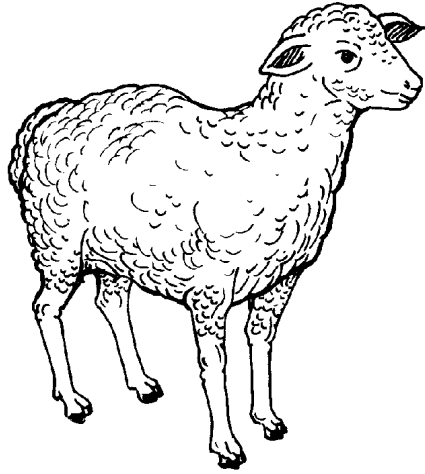

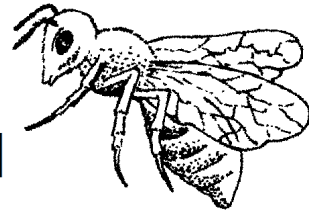

aA

abeja

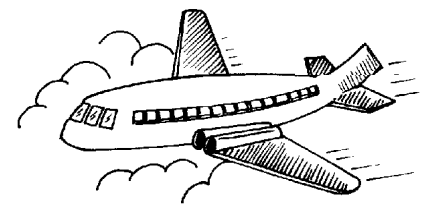

ala



avión

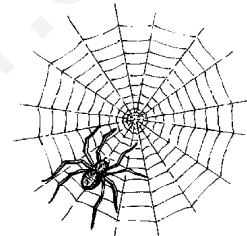

araña



a a a a a a a

A A A A A

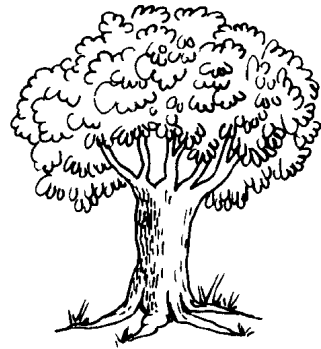

qA

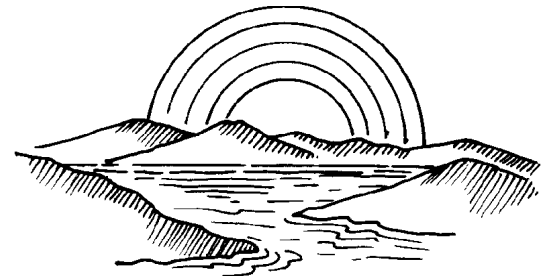
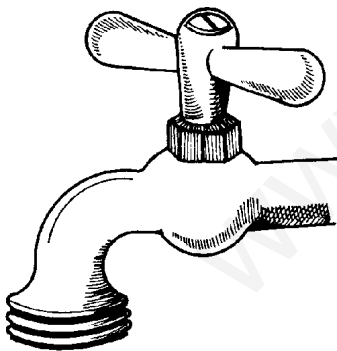
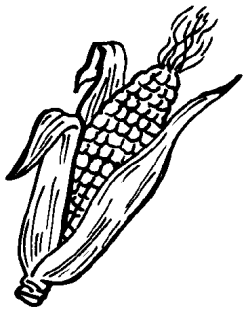
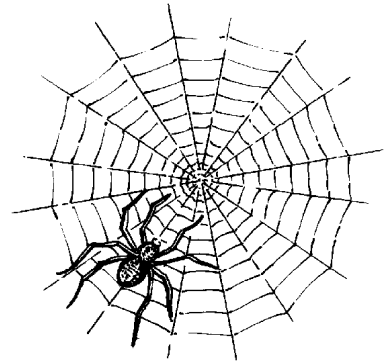

uU

uña

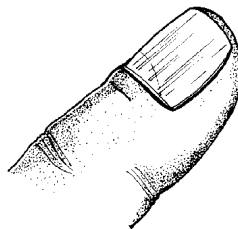

uniforme



uva

1

uno

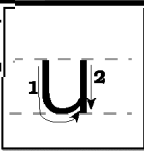

u u u u u u u u

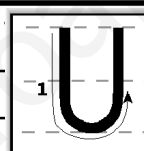

U U U U U U U

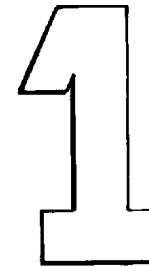
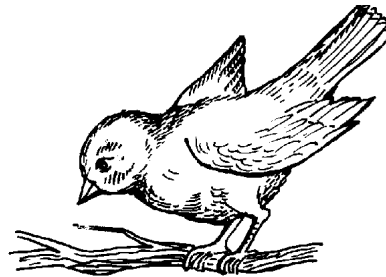
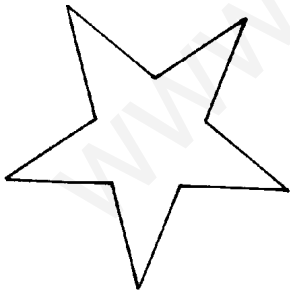
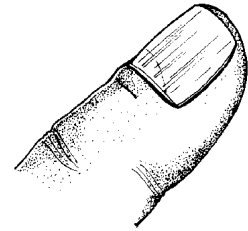
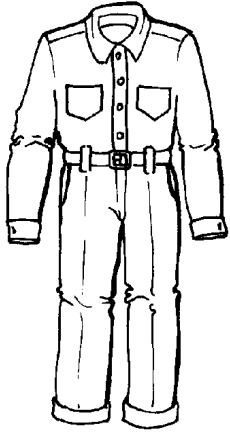
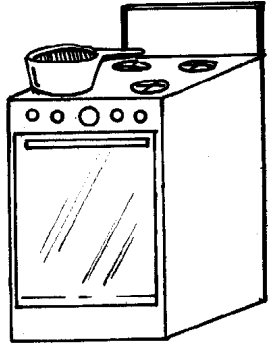





elote



escoba

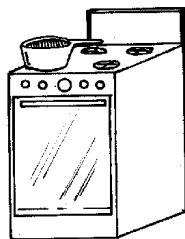
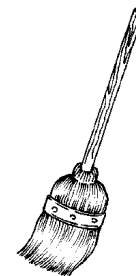

estufa

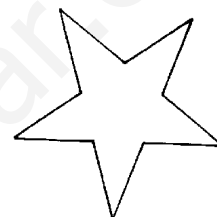

estrella

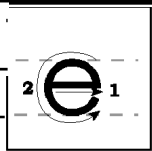

e e e e e e e e

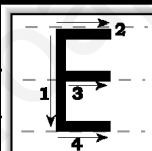

E E E E E E E

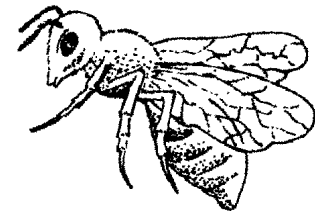
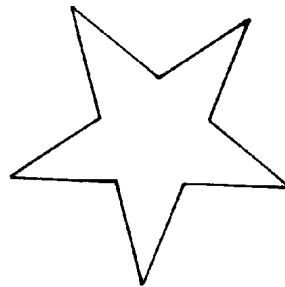
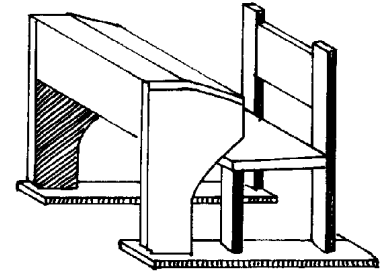
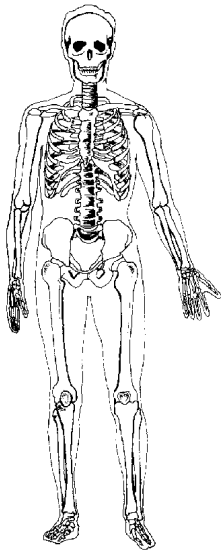
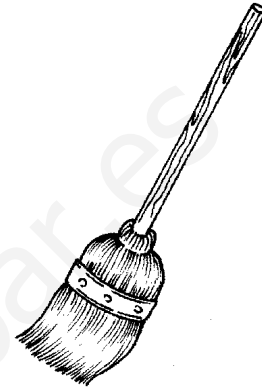
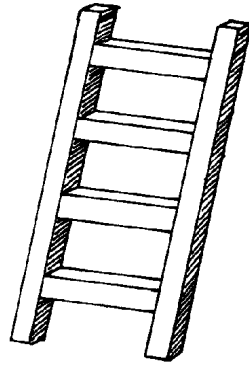
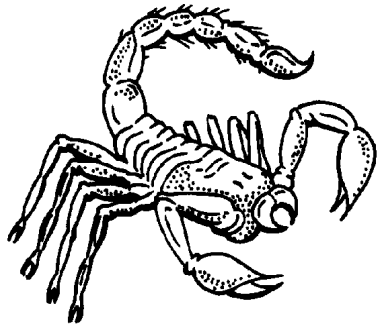



i u



i u



e a

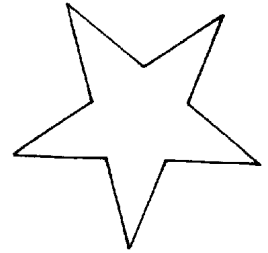

o e

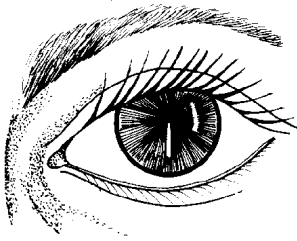

e o



e a



a o



i e

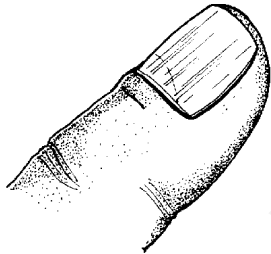

i u

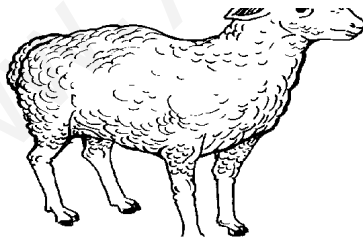

o e



a o

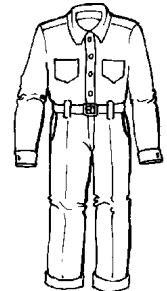

u e



U

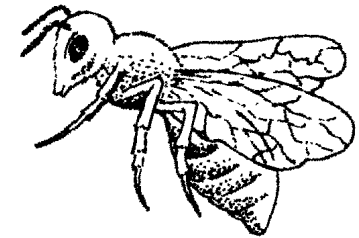
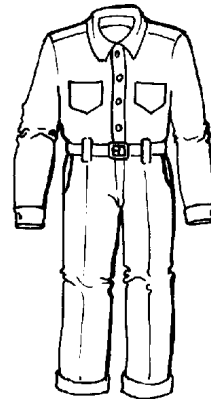
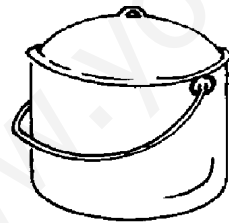
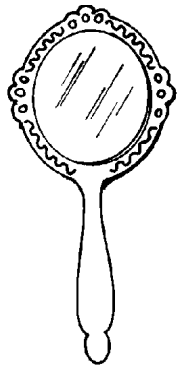
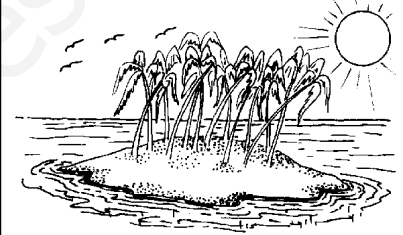
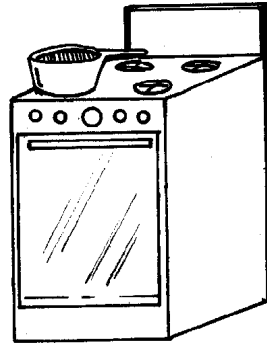

pP

papa

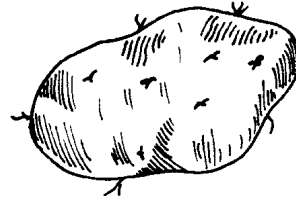

puma

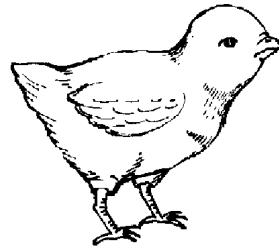
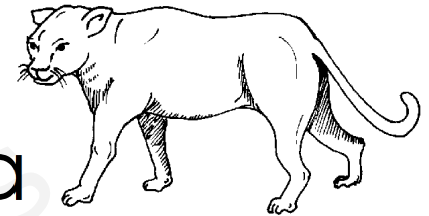

pollo

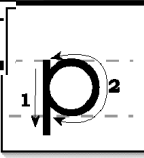
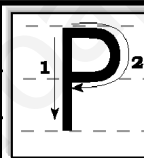

pelota

  <p>p p p p p p p p</p>	 <p>P P P P P P</p>



**p P**

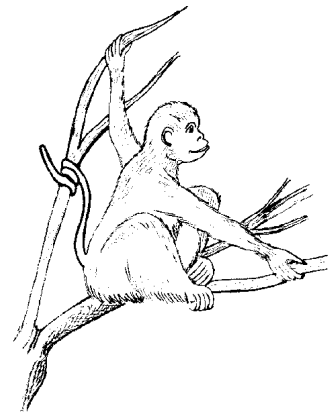
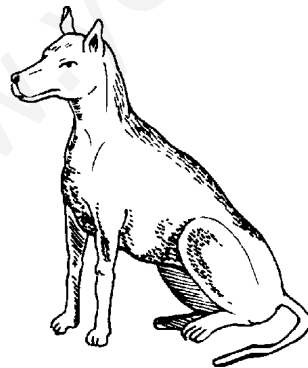
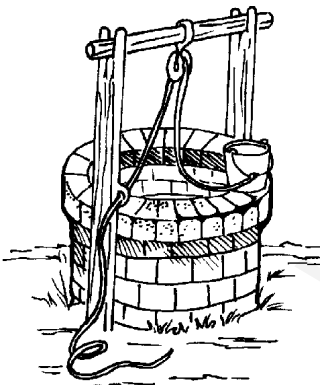
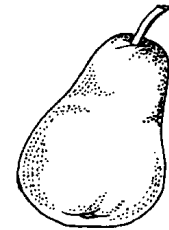
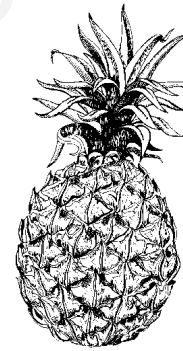
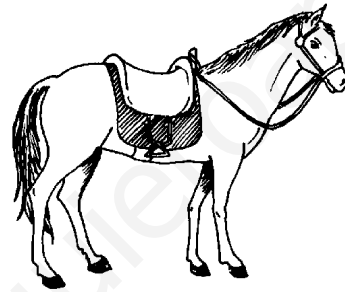
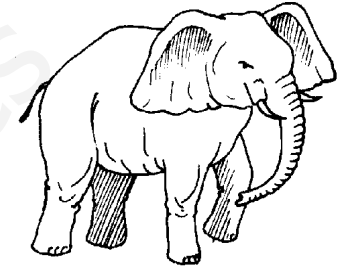
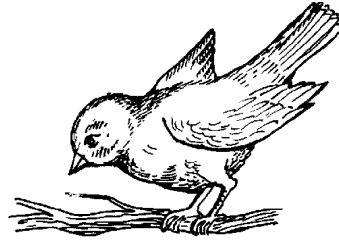
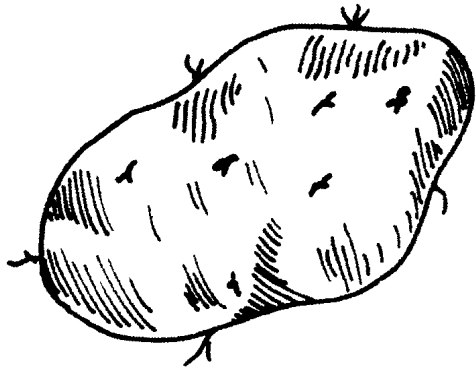

papa  
pa pa  
p a p a  
pa pa  
papa

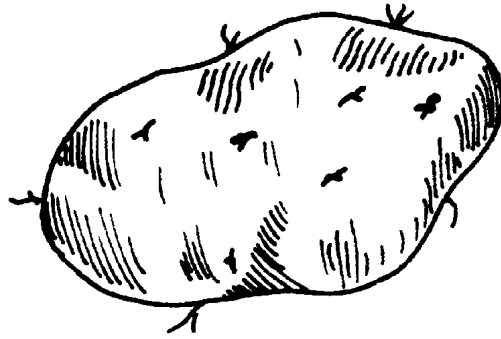

p  
i  
o  
e  
a  
u

pi  
po  
pe  
pa  
pu

**papá**

**papa**

**Pepe**



papá

papa

Pepe

papa

Pepe

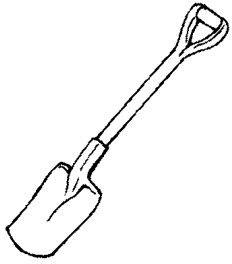

\_\_\_la



\_\_\_ña

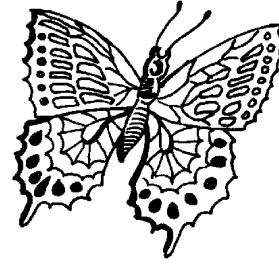

mari\_\_\_sa

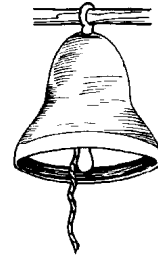

cam\_\_\_na



\_\_\_lo

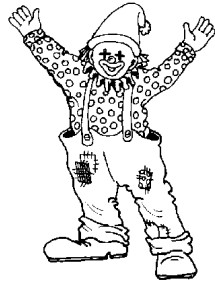

\_\_\_yaso



\_\_\_no

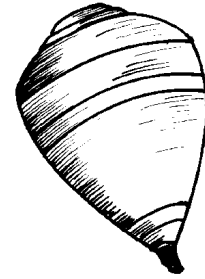

trom\_\_\_

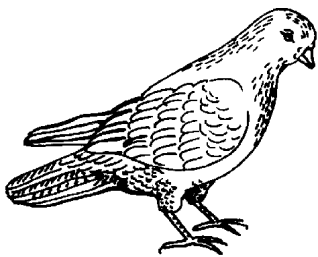

\_\_\_loma



chu\_\_\_te

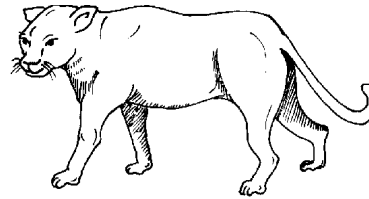

\_\_\_ma



ama\_\_\_la





pala

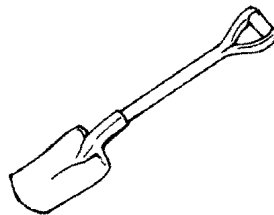







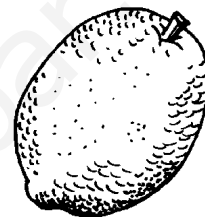



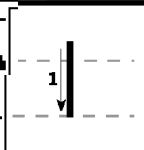
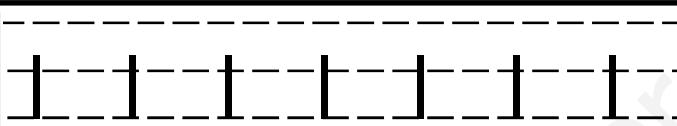
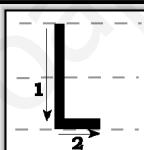





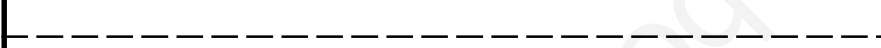
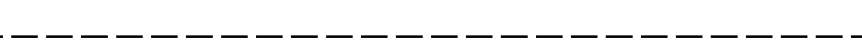



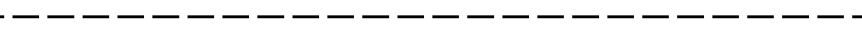

pelo

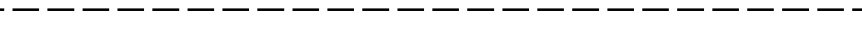

luna

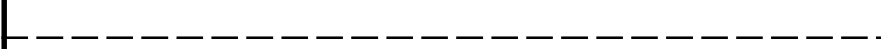
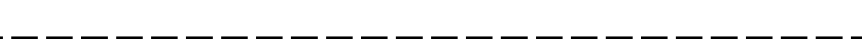

limón



IL

---

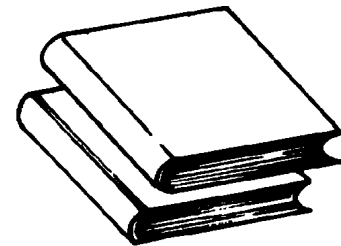
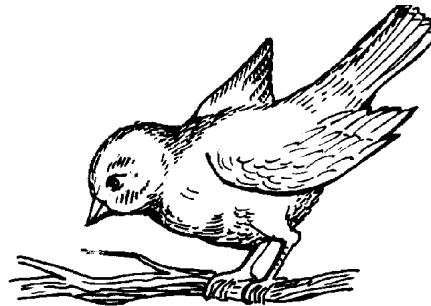
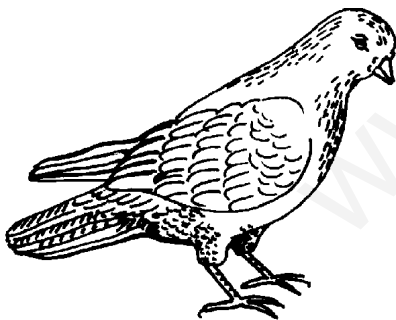
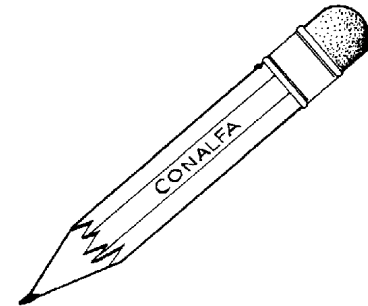
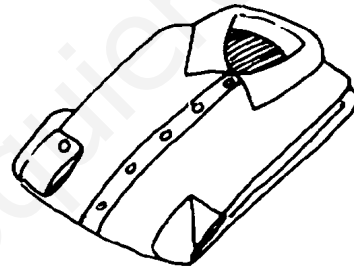
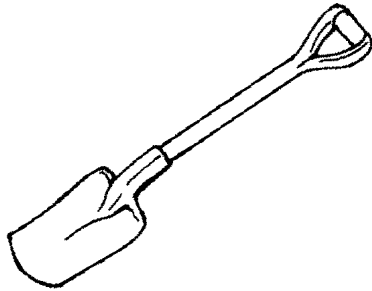
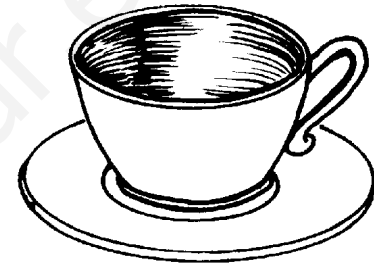
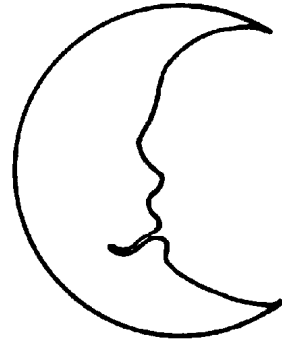

pala  
pa la  
p a l a  
pa la  
pala

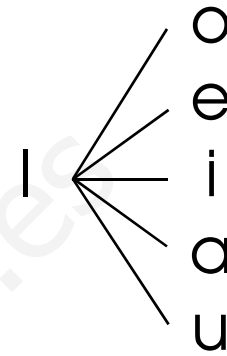
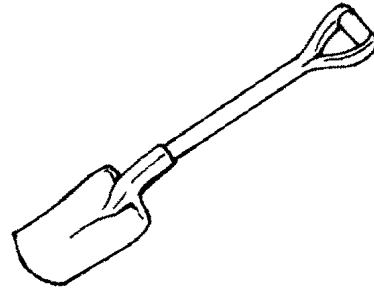

lo  
le  
li  
la  
lu

## el - al



lila

Lulú

pelo

pela

pila

lupa

Lola

plalo

la pila

la pala

Lupe lee

Lola pela la papa

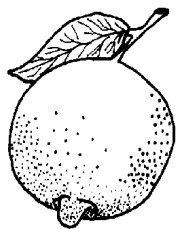

\_\_ma



\_\_na

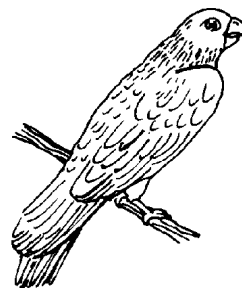

\_\_ro

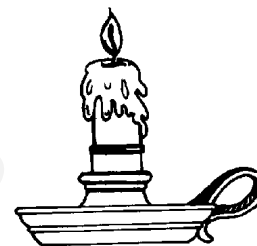

cande\_\_ro



\_\_bios

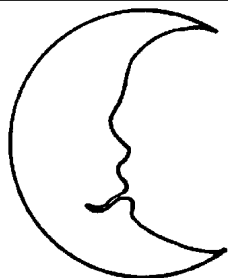

\_\_na



he\_\_do

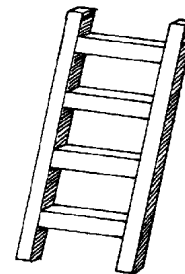

esca\_\_ra



e\_\_te

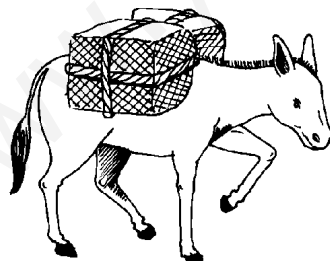

mu\_\_



po\_\_cía

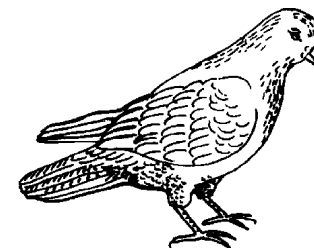

pa\_\_ma



pato

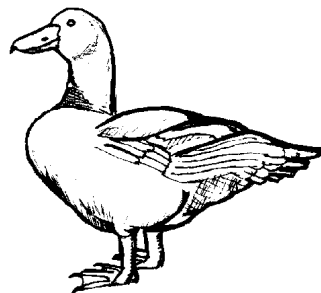

tenedor

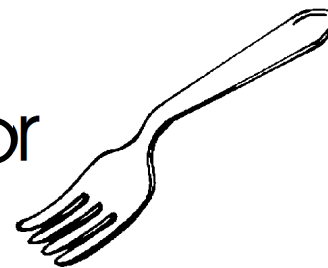

taza

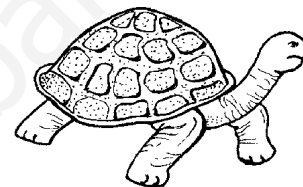

tortuga

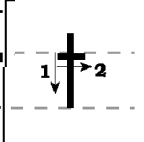
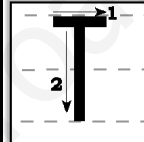
 	
t t t t t t t t	T T T T T T T T



† T

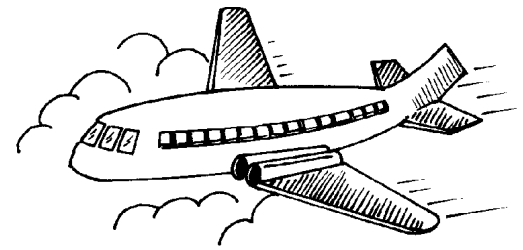
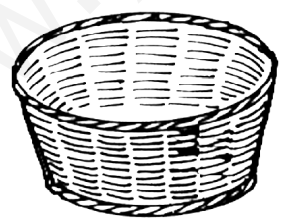
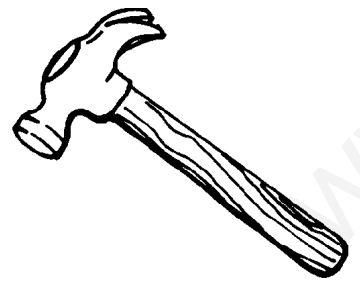
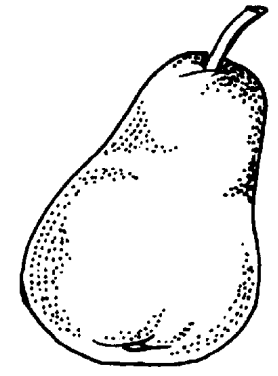
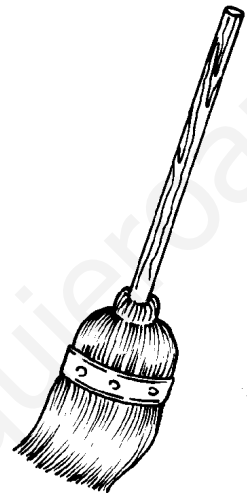
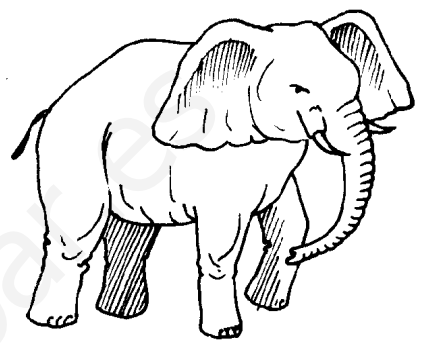
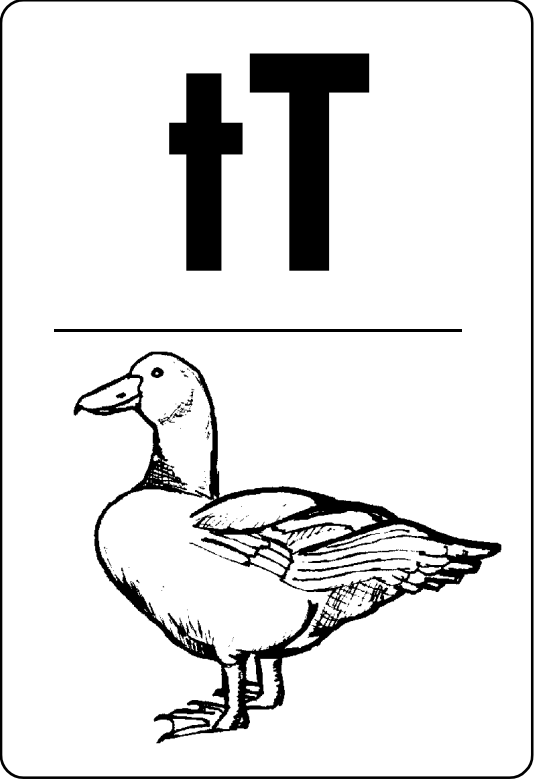

pato  
pa to  
p a t o  
pa to  
pato

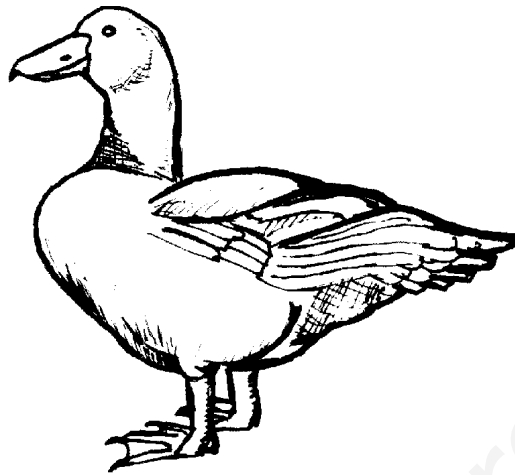

t  
u  
o  
a  
i  
e

tu  
to  
ta  
ti  
te

Tita

lote

pata

tela

atol

tapa

pelota

petate

Tilapa

elote

el pato

la pelota lila

Tita pela la pata.

Lipe tapa el atol.

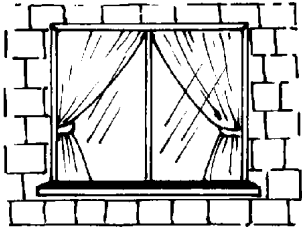

ven\_\_na



\_\_naja



bo\_\_



elo\_\_

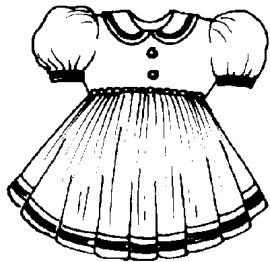

ves\_\_do

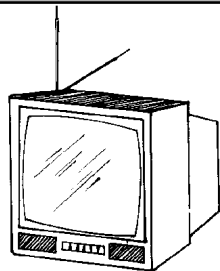

\_\_levisor

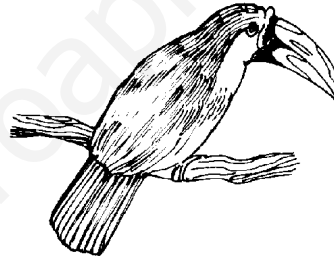

\_\_cán

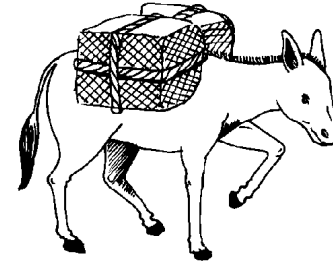

muli\_\_

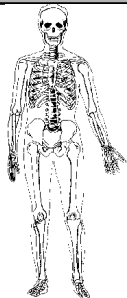

esquele\_\_

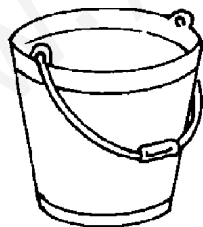

cube\_\_

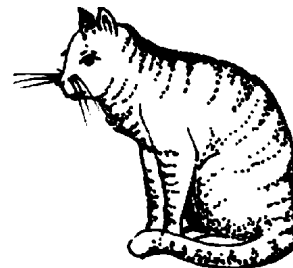

ga\_\_

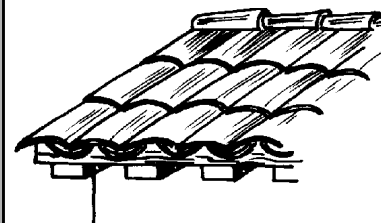

\_\_ja



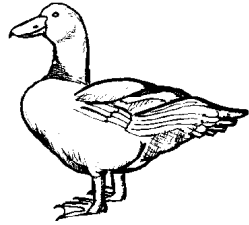

petate

elote



tapa

tela

atol

Tita

pelota

Tita

Tapa

pato

atol

tela

petate

elote

mM

tomate

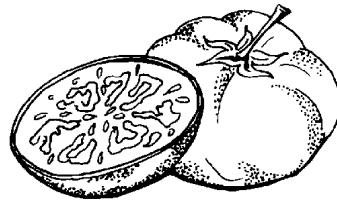

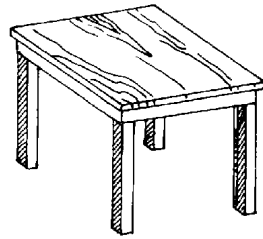
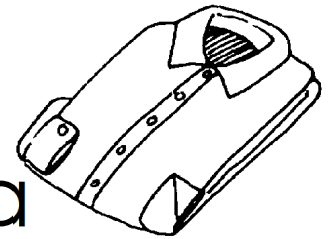

camisa



mesa

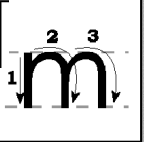

moña

 m m m m m	 M M M M M



mM

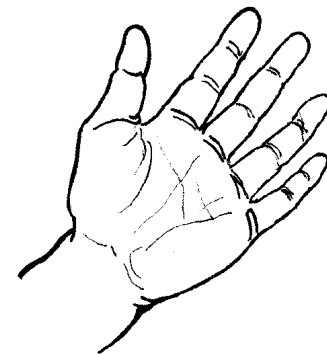
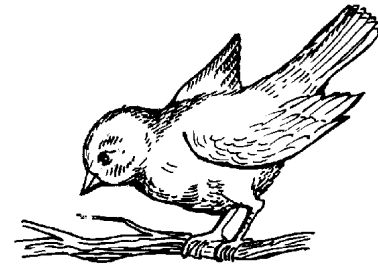
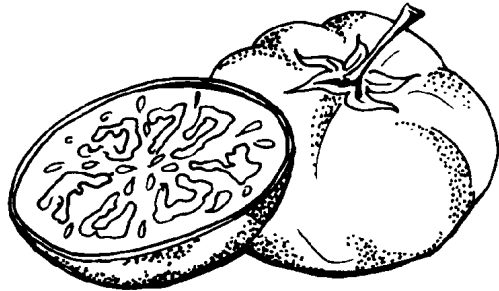
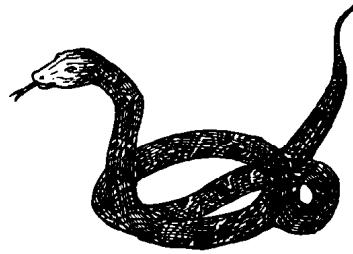

tomate  
to ma te  
t o m a t e  
to ma te  
tomate

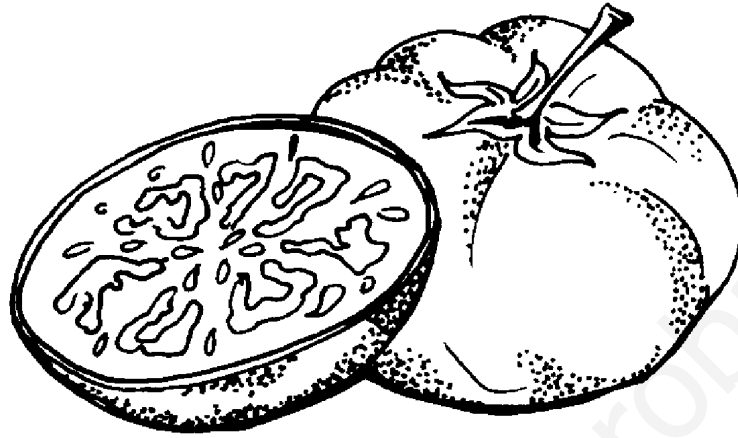

m — i  
o  
e  
a  
u

mi  
mo  
me  
ma  
mu

mapa

muleta

Meme

paloma

mima

milpa

ama

malo

Ema

moto

tu tomate

la mata

Toma el té.

Lola pela el tomate.

Toma el tomate Lili.

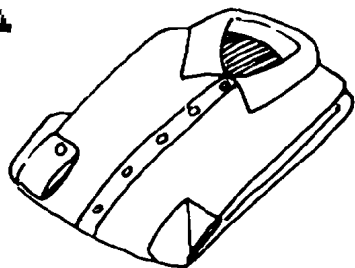

ca\_\_\_\_\_sa

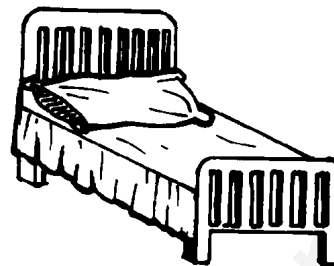

ca\_\_\_\_\_

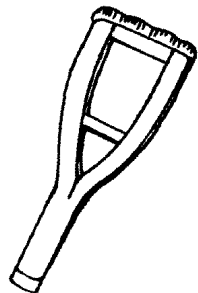

\_\_\_\_\_leta

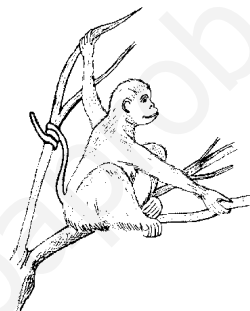

\_\_\_\_\_no

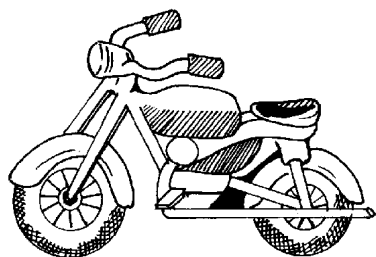

\_\_\_\_\_to

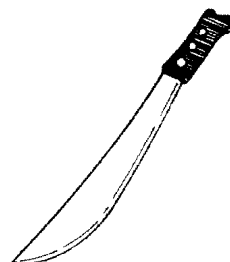

\_\_\_\_\_chete

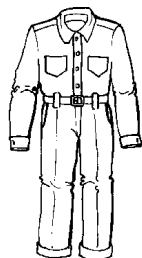

unifor\_\_\_\_\_

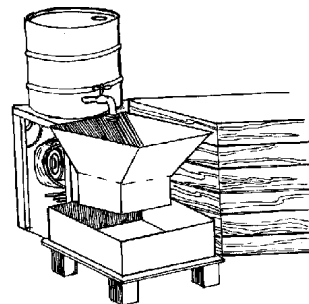

\_\_\_\_\_lino



**papá**

pipa

papá

pepe

**pila**

pila

pela

palo

**petate**

pelota

paleta

petate

**tomate**

tomate

matate

Timoteo

**paloma**

pelota

paloma

petate

**muleta**

maleta

mulita

muleta

sS

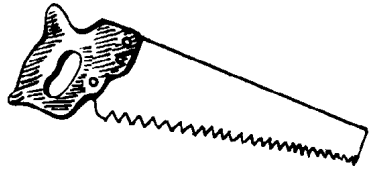

serrucho



masa



vaso

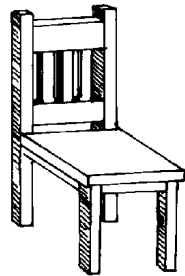

silla



<p>s s s s s s s s</p>	<p>S S S S S S S</p>



sS

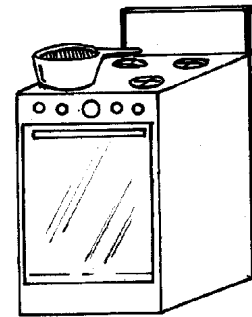
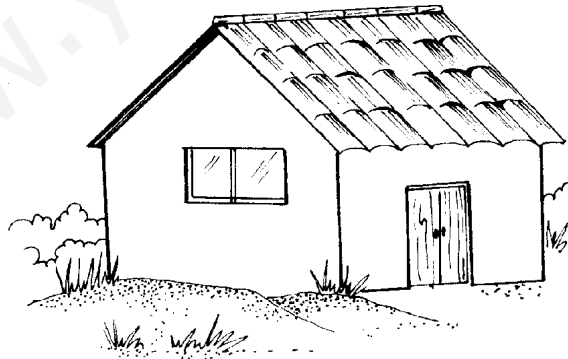
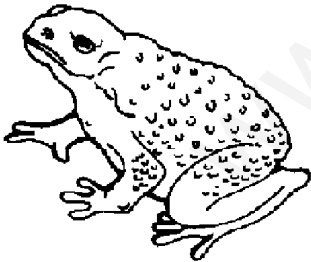
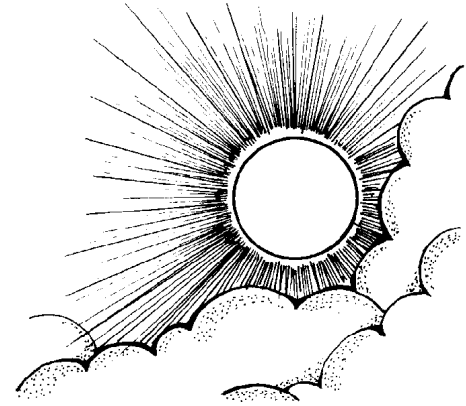
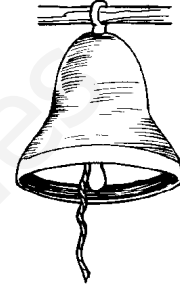



masa  
ma sa  
m a s a  
ma sa  
masa



s i  
o  
e  
a  
u

si  
so  
se  
sa  
su

**es - as**

suelo

tos

pesa

Susi

sapito

suma

asma

Estelita

esposo

mesa limpia

Susi amasó la masa.

Lola pasa la sopa.

Mimi limpia la mesa.

Ese sapo está solo.

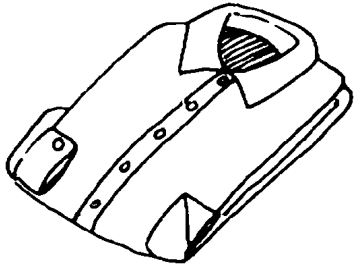

cami\_\_\_\_\_



paya\_\_\_\_\_

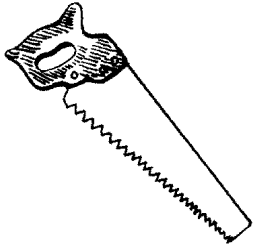

\_\_\_\_\_rrucho

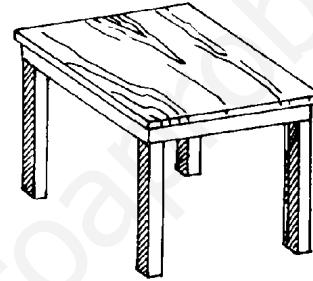

me\_\_\_\_\_



o\_\_\_\_\_

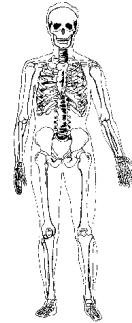

\_\_\_\_\_queleto

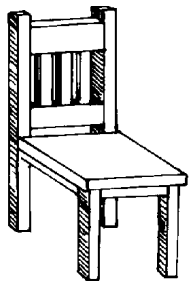

\_\_\_\_\_lla

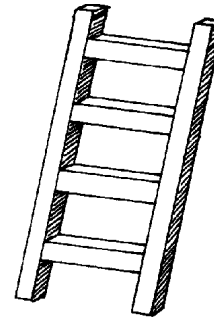

\_\_\_\_\_calera



sopa

sala

Tomasa

sapito

pesa

Tomás

pasa

sal

pasa

sapito

sal

sala

Tomás

sopa

pesa

Tomasa

fF

familia

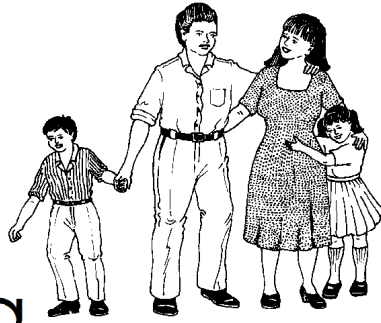

fogata

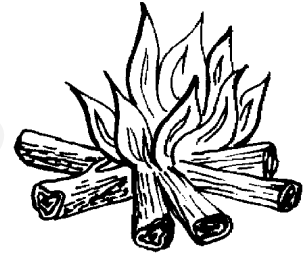

foco

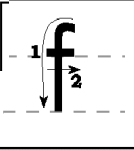
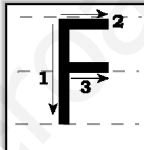

 	f f f f f f f f		F F F F F F



**fF**

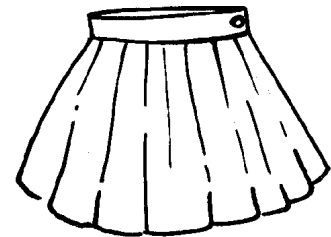
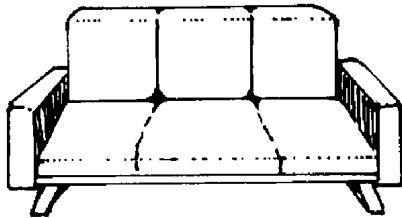
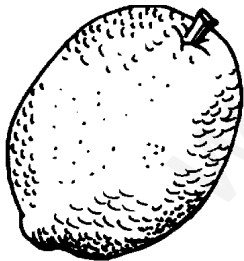
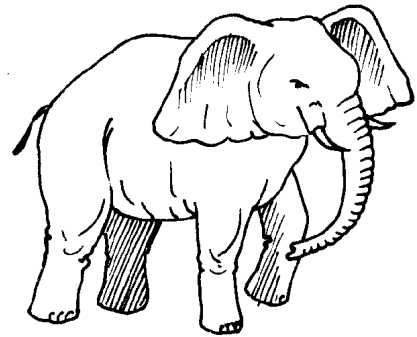
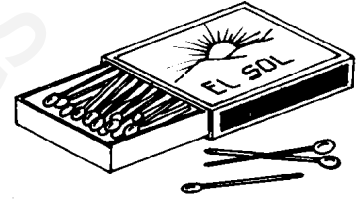
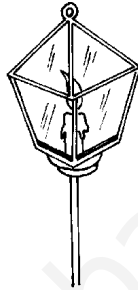
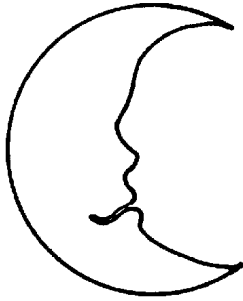
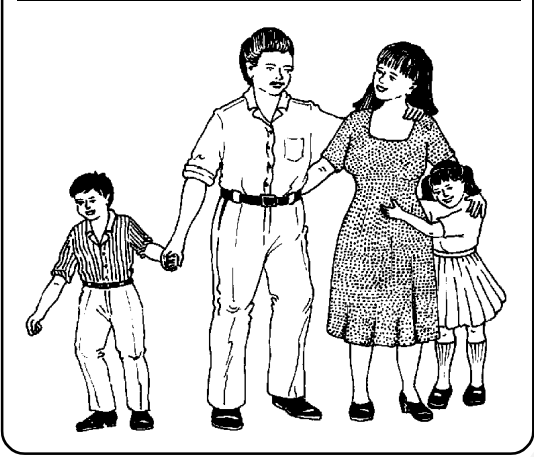

familia  
fa mi lia  
f a m i l i a  
fa mi lia  
familia



f

u  
o  
a  
i  
e

fu  
fo  
fa  
fi  
fe

filo

foto

fuma

fósforo

fosa

Fito

famoso

falso

fe

feo

estufa

falta

mi familia

esas fotos feas

La familia toma atol.

Sofía falta tu foto.

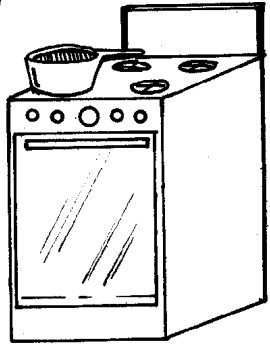

estu\_\_\_

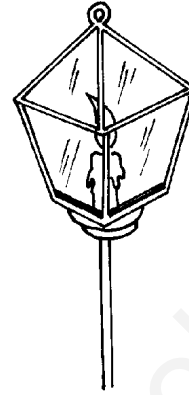

\_\_\_rol

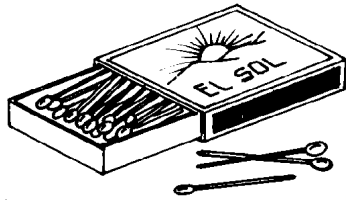

fós\_\_\_ros



\_\_\_to

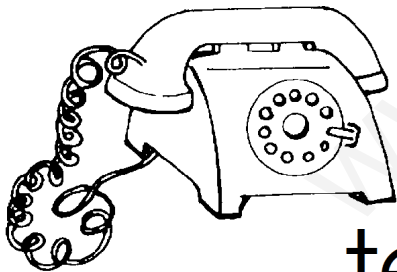

telé\_\_\_no



ca\_\_\_to



esa

la

tus

mis

mi

tu

esas

las

\_\_\_\_\_ foto

\_\_\_\_\_ fotos

\_\_\_\_\_ foto

\_\_\_\_\_ fotos

\_\_\_\_\_ foto

\_\_\_\_\_ fotos

\_\_\_\_\_ foto

\_\_\_\_\_ fotos



EVALUACION DE PROCESO

**NOMBRE:** \_\_\_\_\_ **FECHA:** \_\_\_\_\_ **LE - 1**

**1**



pipa  
patito  
palo  
elote  
pelota

**2**



oso  
estufa  
mopa

**3**

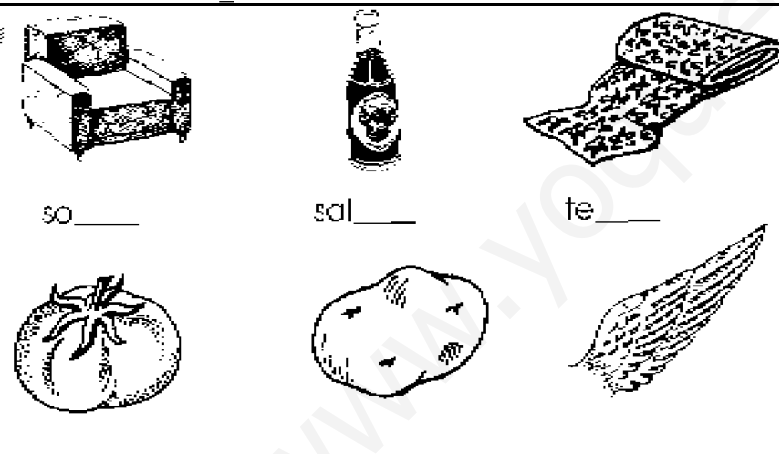

sofa  
sal  
tortilla  
tomate  
papa  
pluma

**4** Tomaso pela la \_\_\_\_\_  
papa pala mula

Mi mamá limpia la \_\_\_\_\_  
pelo mesa sapo

Lolo muele la \_\_\_\_\_  
misa masa pesa



**c**asa

**c**una

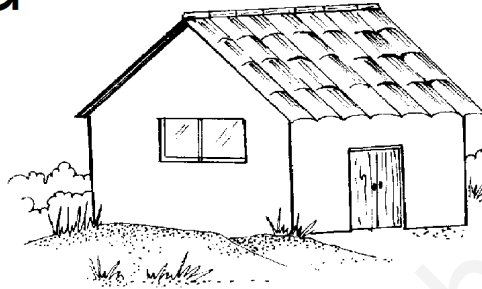
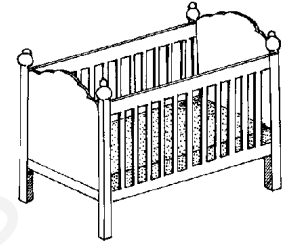

**c**oco



**c**ama

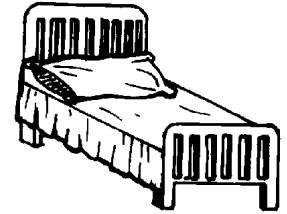

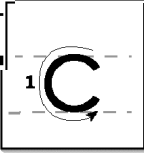
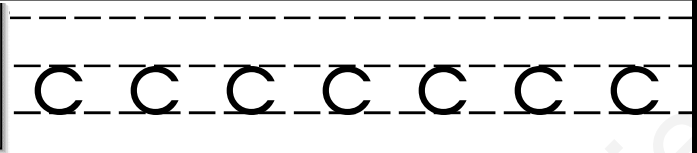
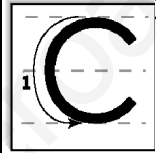
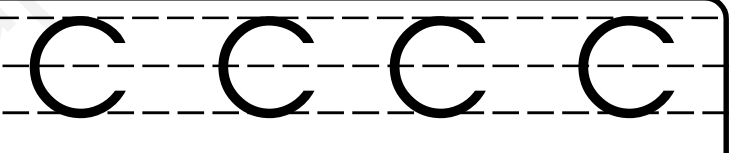

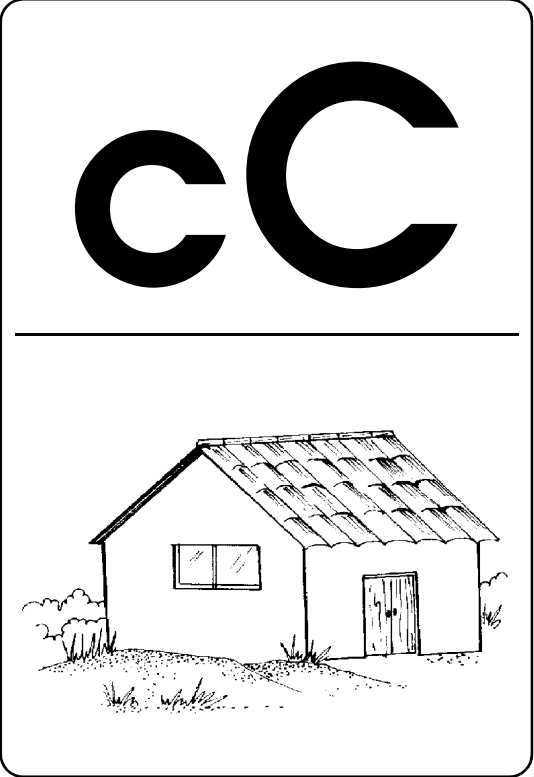

c C

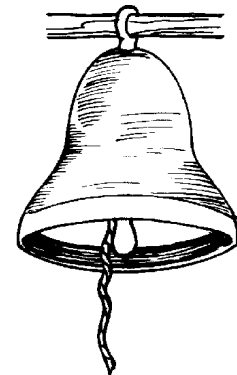
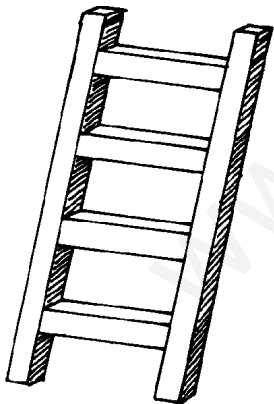
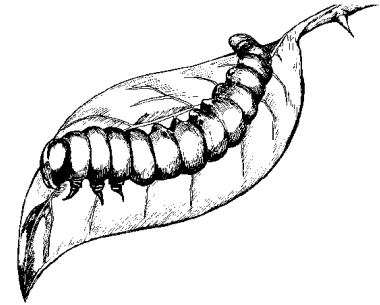
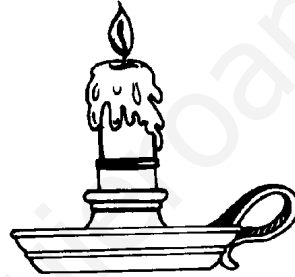
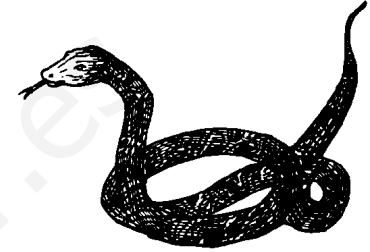
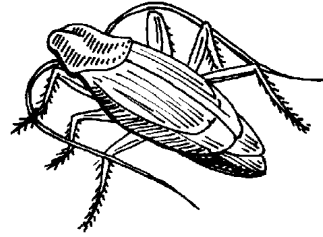
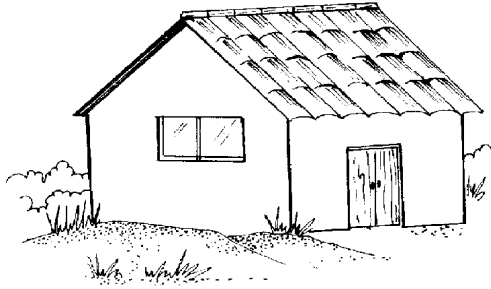

casa  
ca sa  
c a s a  
ca sa  
casa

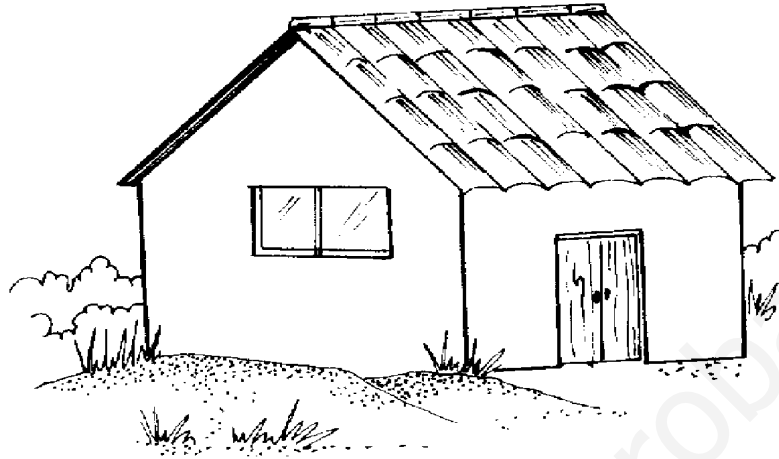

c

- a
- o
- u

ca

co

cu

coco

escuela

calma

casita

cola

Camilo

toca

camita

camisa

cacao

mosca

culto

La casa es mía.

Lupe usa la capa.

Lola come coco.

Camila limpia la casa.

La escuela es como una casa.

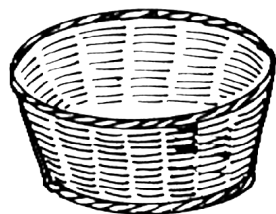

\_\_\_nasto

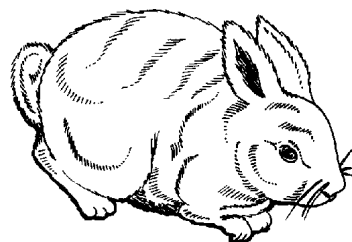

\_\_\_nejo

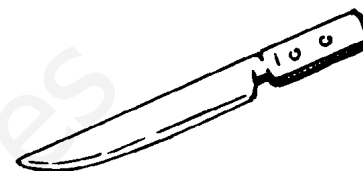

\_\_\_chillo

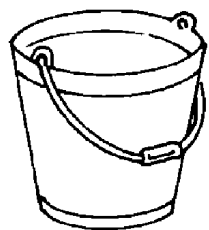

\_\_\_beta



es \_\_\_do



pas \_\_\_a



te \_\_\_lote

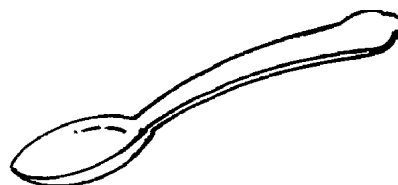

\_\_\_chara

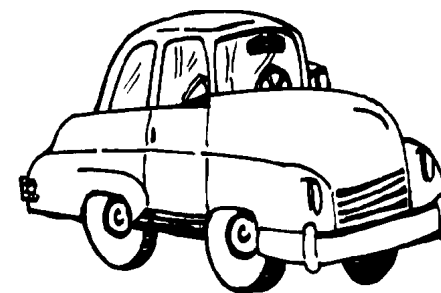

\_\_\_rro



casa

tecolotes

tecomate

sacos

cola

capas

camas

coco

esta

\_\_\_\_\_

esos

\_\_\_\_\_

la

\_\_\_\_\_

las

\_\_\_\_\_

ese

\_\_\_\_\_

el

\_\_\_\_\_

los

\_\_\_\_\_

esas

\_\_\_\_\_

dD

comida

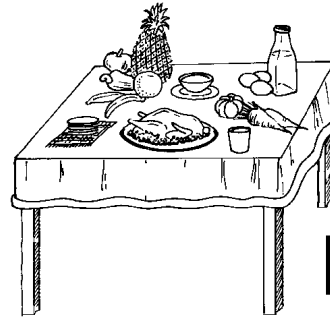

bandera

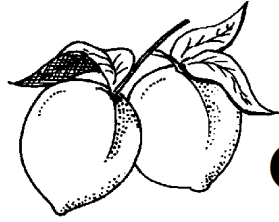
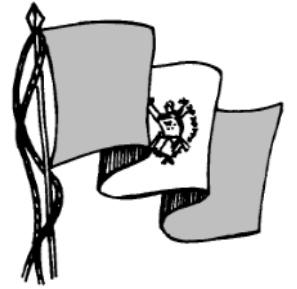

durazno

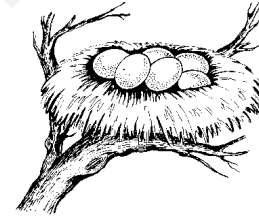

nido

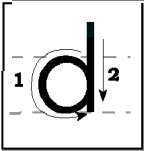

d d d d d d d d

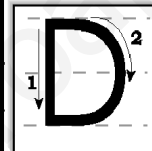

D D D D D D D



dD

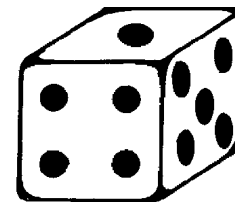
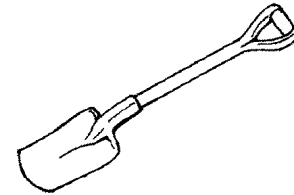
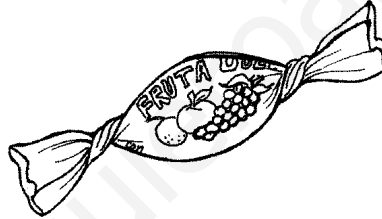
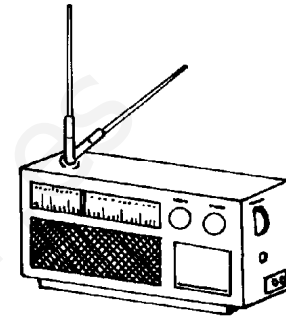
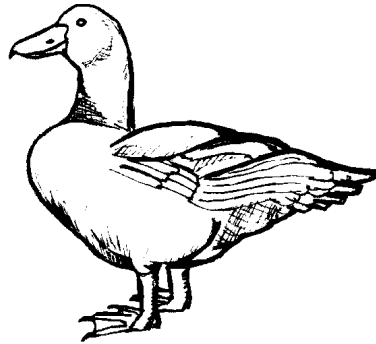
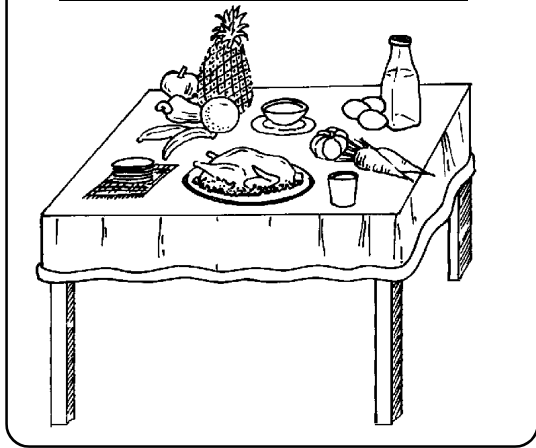



comida  
co mi da  
c o m i d a  
co mi da  
comida



d i  
u  
e  
o  
a

di  
du  
de  
do  
da

dado

codo

Adela nada sola.

dedo

mudo

La comida está salada.

lodo

duda

Ada le dio sopa a Sofía.

todo

filudo

Fito come pescado seco.

seda

dos

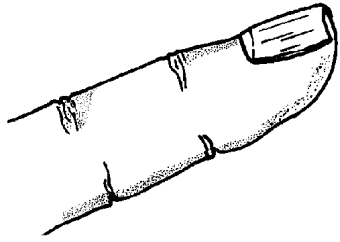

de\_\_

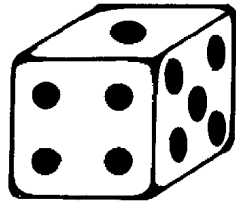

\_\_do

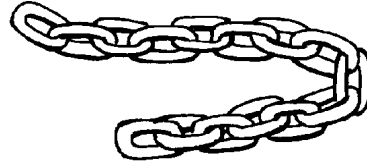

ca\_\_na

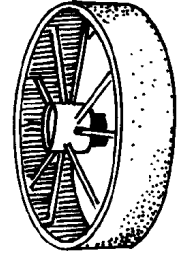

rue\_\_



can\_\_la

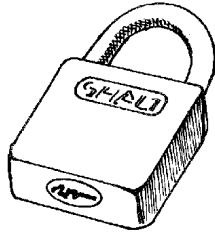

can\_\_do



hela\_\_



sol\_\_do

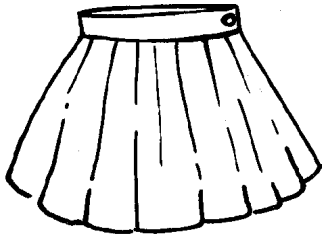

fal\_\_

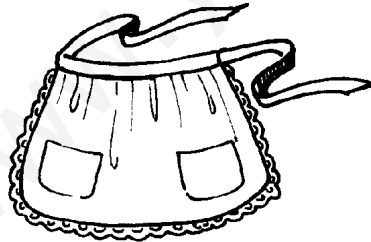

\_\_lantal

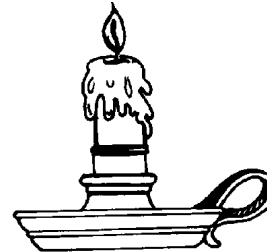

can\_\_lero



\_\_nero



soldado

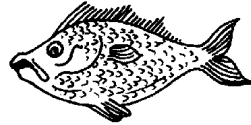

tamal

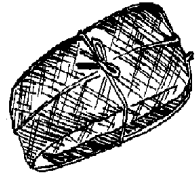

sopa



falda



pescado



elote

**nN**

camino



luna



conejo

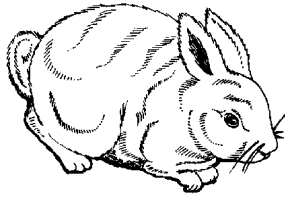

nube

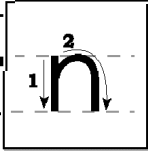

n n n n n n n n

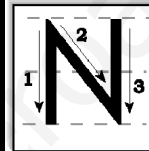

N N N N N N



nN

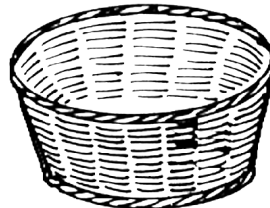
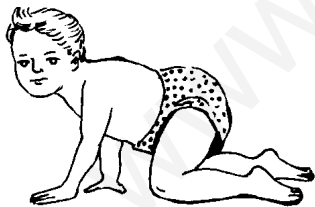
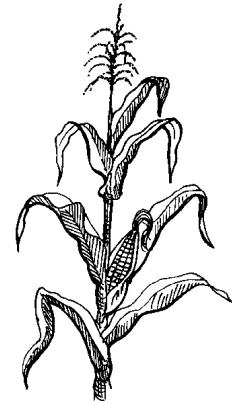
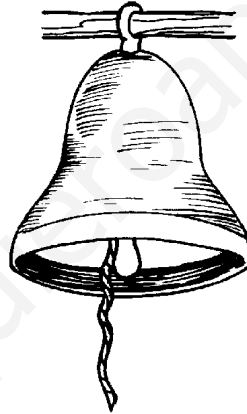
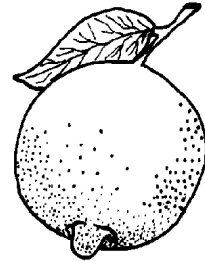
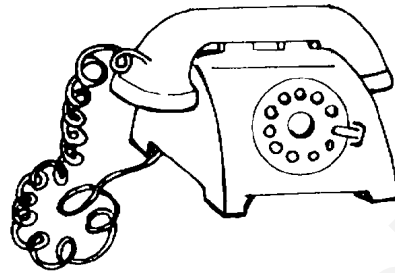

camino  
ca mi no  
c a m i n o  
ca mi no  
camino



n  
u  
o  
e  
i  
a

nu  
no  
ne  
ni  
na

## an - en - un - in - on

mano

molino

lámina

pino

nada

lana

uno

campana

nene

teléfono

Maco limpia de lodo el camino.

Dina camina de la mano con su nene, en el camino limpio.

Nidia saca la masa del molino con la mano.

¡Cuidado con la mano, Nidia!

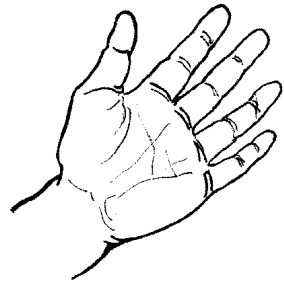

ma\_\_\_\_\_

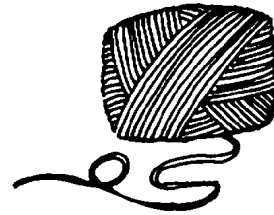

la\_\_\_\_\_

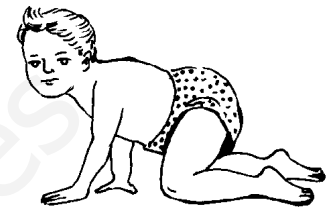

ne\_\_\_\_\_

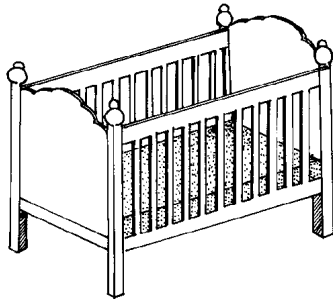

cu\_\_\_\_\_

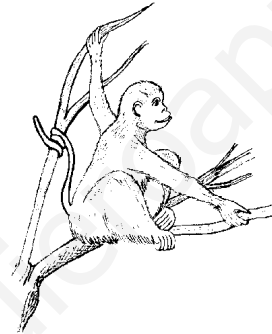

mo\_\_\_\_\_

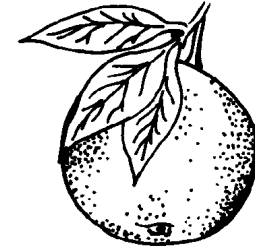

\_\_\_\_\_ranja

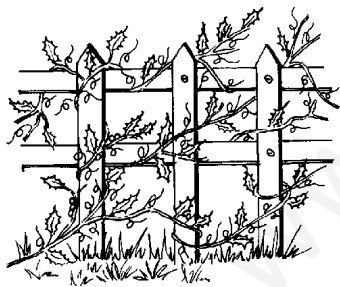

\_\_\_\_\_redo



\_\_\_\_\_torcha

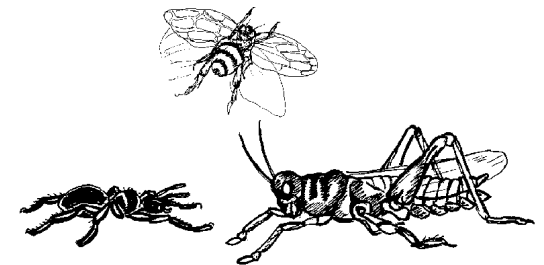

\_\_\_\_\_sectos



Tomás toma atol de \_\_\_\_\_.

coco

tomate

elote

Paco come \_\_\_\_\_.

tamal

tonel

comal

Catalina \_\_\_\_\_ el tomate.

fuma

lee

cuela

Camila \_\_\_\_\_ las papas.

lee

camina

pela



bB

abono



banano

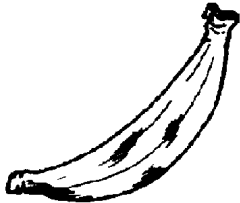

bicicleta

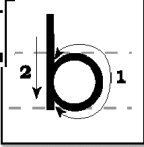
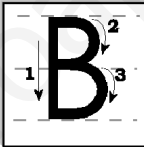

nube

	b b b b b b b		B B B B B B



**bB**

---

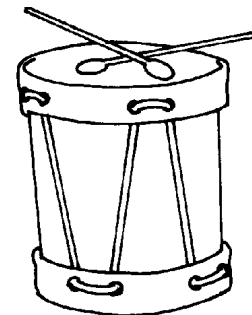
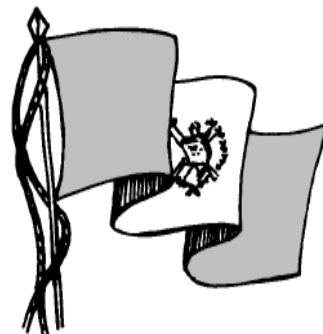
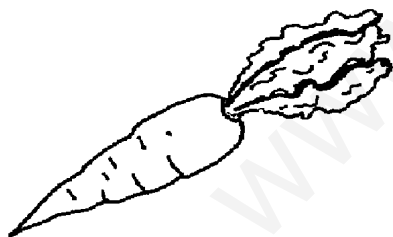
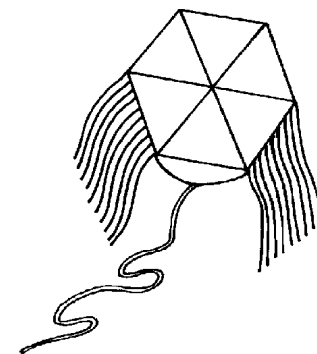
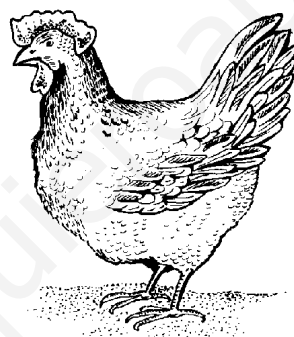

abono  
a bo no  
a b o n o  
a bo no  
abono



b i  
o  
a  
u  
e

bi  
bo  
ba  
bu  
be

bota

bola

bote

bata

bueno

tubo

sube

botón

bonito

Beto

El abono es útil.

Beto abonó la milpa.

Esa milpa dio buenos elotes.

Anabela toma atol de elote.



Estela usa la  
Estela usa la \_\_\_\_\_.

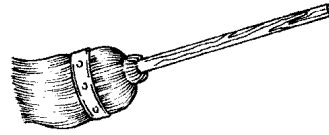

Inés se pone las  
Inés se pone las \_\_\_\_\_.



Lupe come  
Lupe come \_\_\_\_\_.



Pepe tiene una  
Pepe tiene una \_\_\_\_\_.

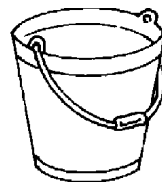

rR

rabia

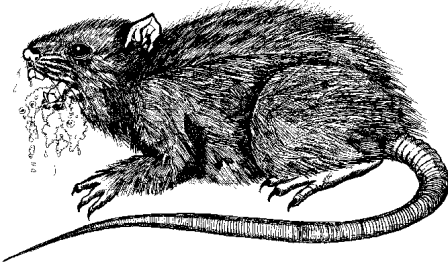

rosa

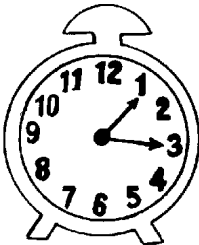

reloj

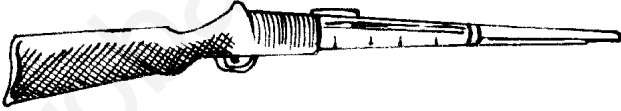

rifle

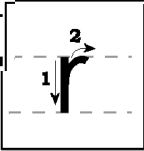

r r r r r r r r r r



R R R R R R R



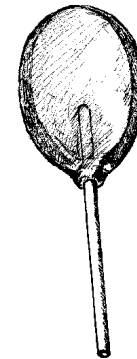
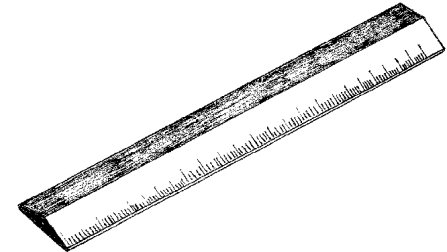
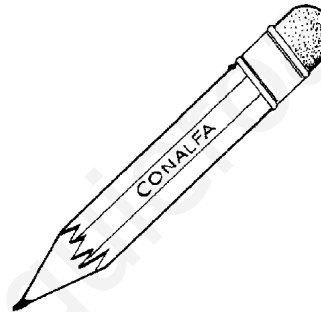
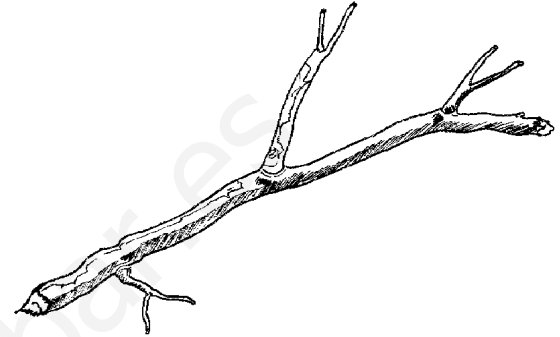
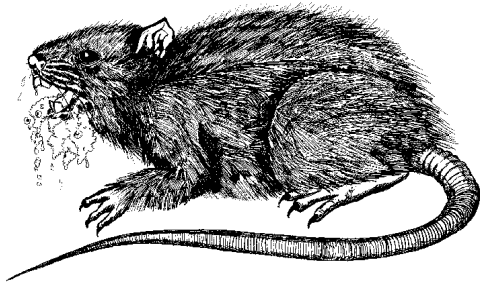

rR

---

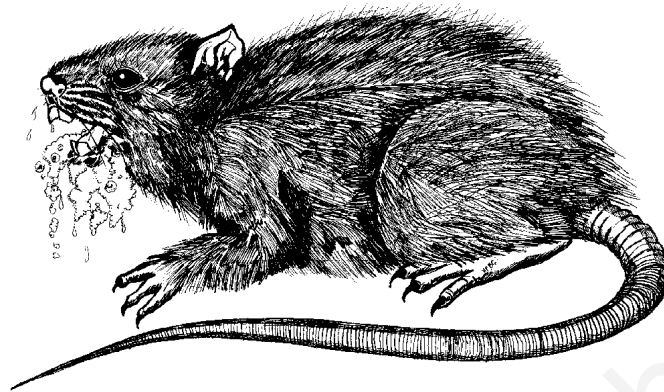

rabia  
ra bia  
r a b i a  
ra bia  
rabia



r a  
e  
i  
o  
u

ra  
re  
ri  
ro  
ru

## ar - er - ir

Rosa	rosado
risa	ruleta
rifa	recado
roca	rico
remo	ruido

Esa rata tiene rabia.

¡Cuidado! No debe mordernos.

La rabia puede causar la muerte.

Si nos muerde un animal con rabia, debemos asistir al Puesto de Salud

arar

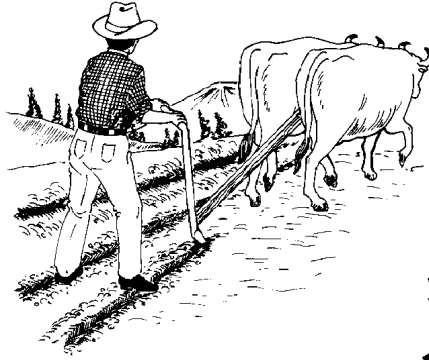

toro

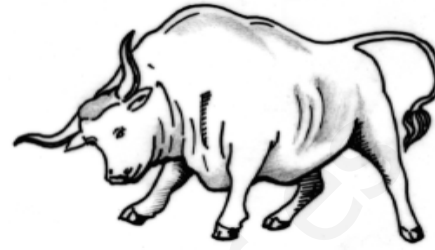

mariposa

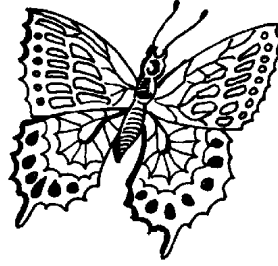

oreja



arado mariposa toro basura toro





rR

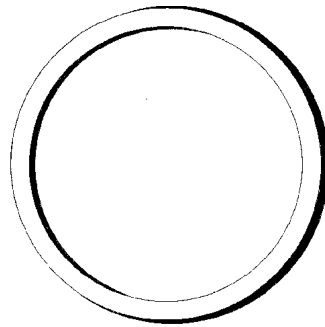
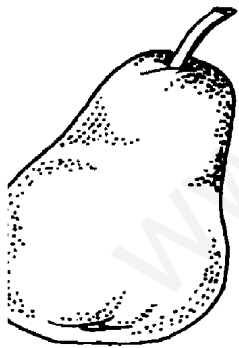
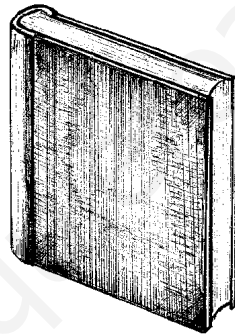
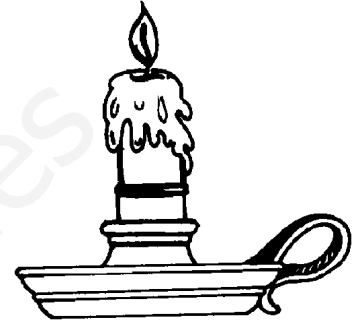
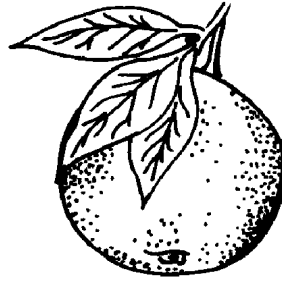
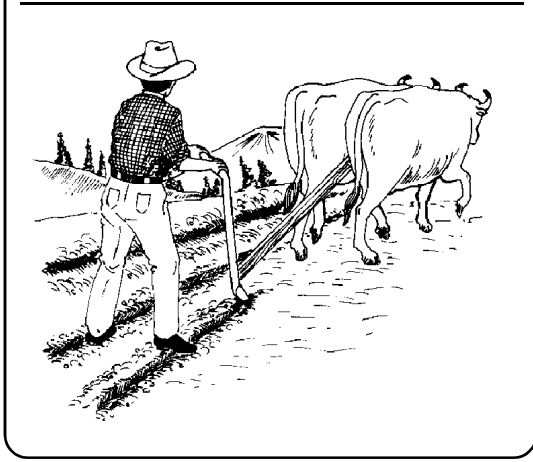

arar  
a rar  
a r a r  
a rar  
arar

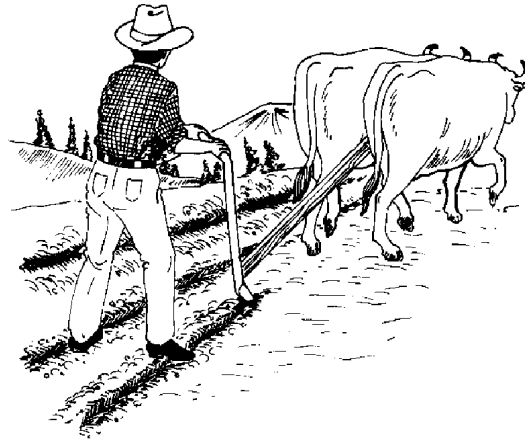

r e  
a  
u  
o  
i

re  
ra  
ru  
ro  
ri

cara

arena

basura

barato

fósforo

arete

María

panadería

escalera

oro

carpintería

candelero

Raúl usa el arado.

Armando aró la tierra de su abuelo Rafael.

María pasea por San José La Arada.

El sábado la marimba tocará en la feria

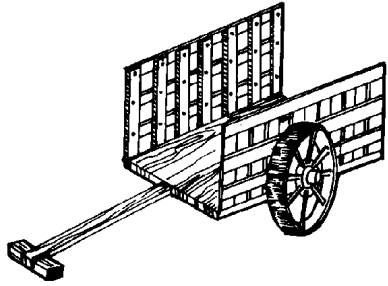

carreta

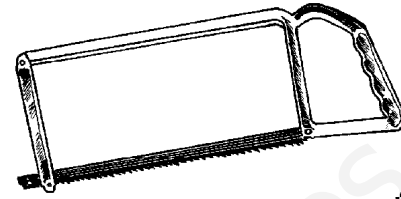

sierra

guitarra

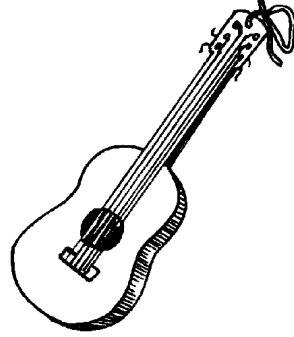

perro

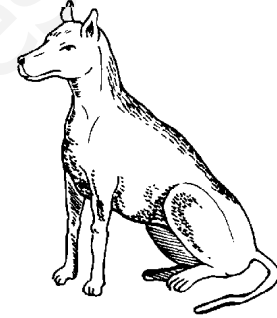

carreta    carrito    sierra    morral



rr

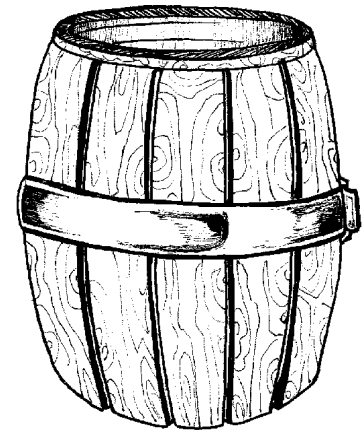
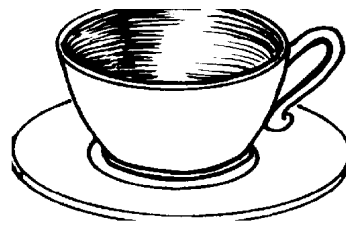
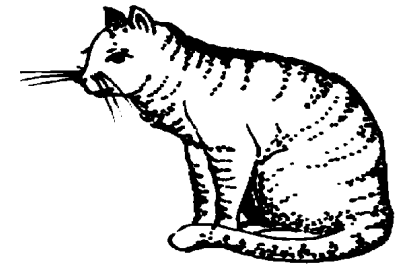
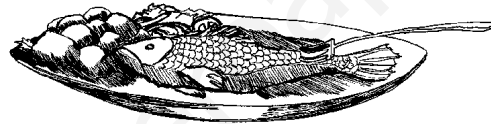
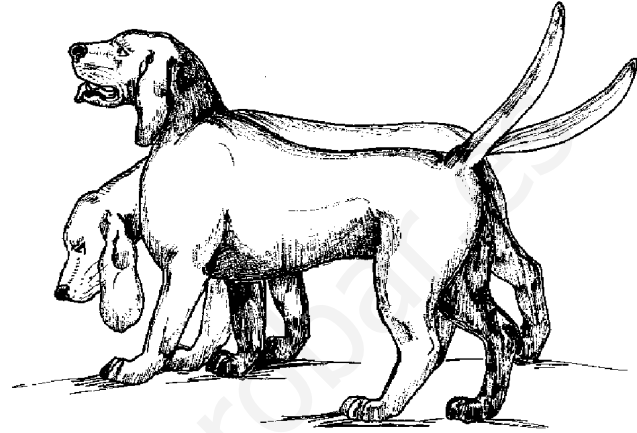
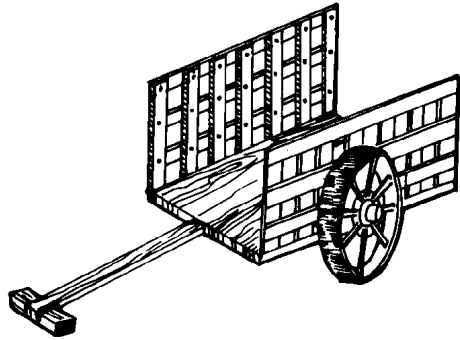

carreta  
ca rre ta  
c a rre t a  
ca rre ta  
carreta

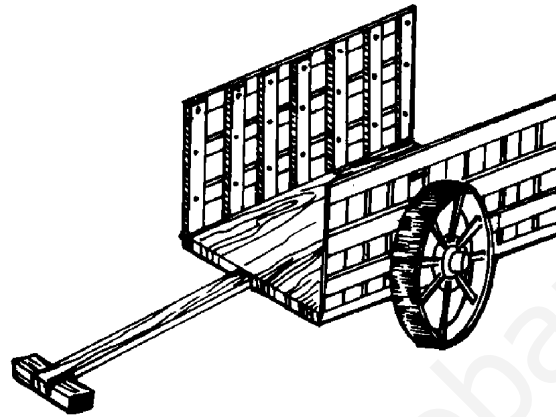

rr

- o
- a
- u
- i
- e

rro  
rra  
rru  
rri  
rre

morral

correo

berro

carrera

carro

corral

perrito

diarrea

terreno

amarrar

carrito

carretera

La carreta es útil en el campo.

Ramón limpia la carreta.

Ramón acarrea tierra en la carreta.

Rita amarra bien su morral a la carreta de Ramón.

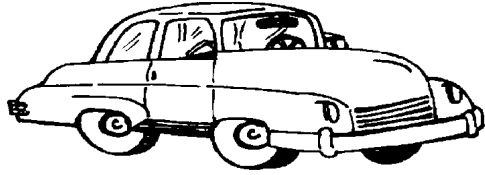

ca\_\_\_\_\_

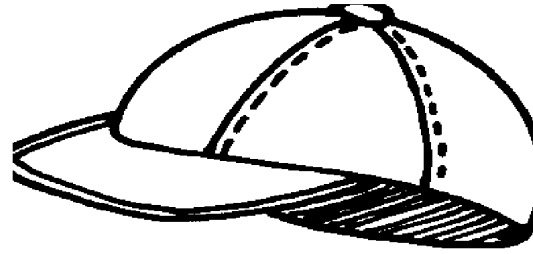

go\_\_\_\_\_

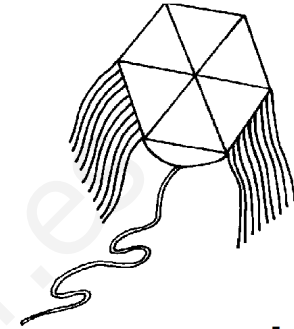

ba\_\_\_\_\_lete



ja\_\_\_\_\_



coto\_\_\_\_\_

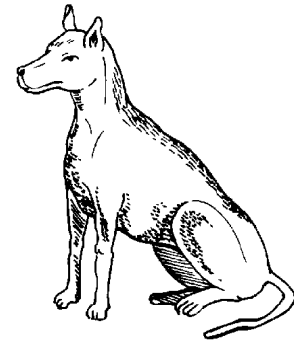

pe\_\_\_\_\_

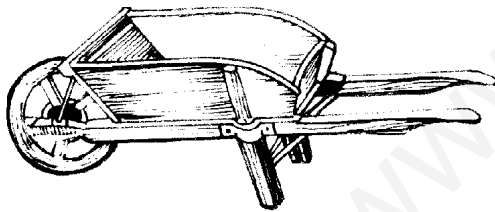

ca\_\_\_\_\_tilla

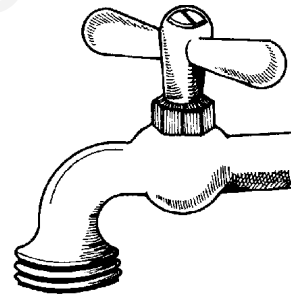

cho\_\_\_\_\_



mo\_\_\_\_\_

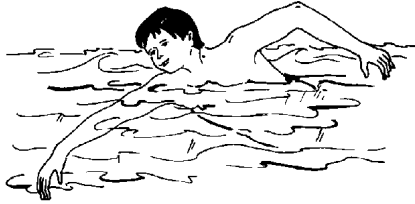

- nadar
- correr
- saltar



- cantar
- leer
- pintar

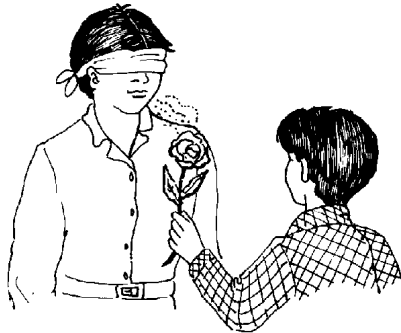

- dar
- oler
- tirar



- moler
- recortar
- pelar

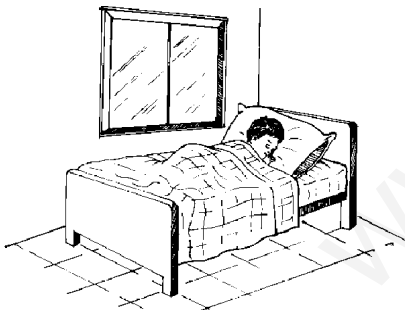

- ir
- caminar
- dormir



- barrer
- morder
- comer

# ch Ch

chile



plancha

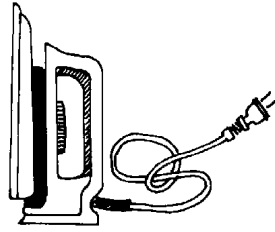

chupete



chorizo

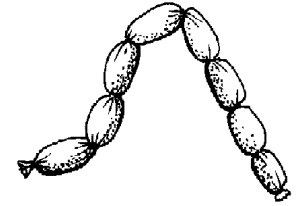

ch ch ch ch ch

Ch Ch Ch Ch



chile  
 chi le  
 ch i l e  
 chi le  
 chile

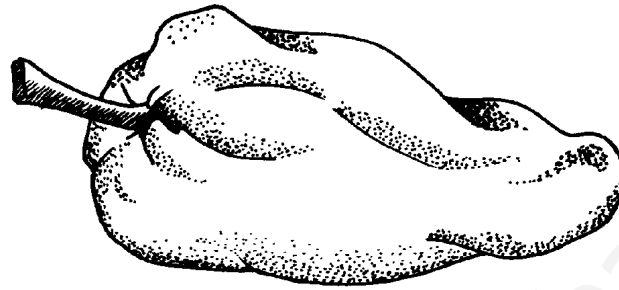

ch i  
 o  
 u  
 a  
 e

chi  
 cho  
 chu  
 cha  
 che

leche

chiltepe

chiche

chorro

machete

chino

cosecha

pache

chaparrón

Chulamar

chamarra

chapear

Este chile pica mucho.

Chepe, limpia los chiles  
 chiltepe

Chalo comió pache con chile  
 anoche.

Checha corre con la antorcha  
 en Carchá.

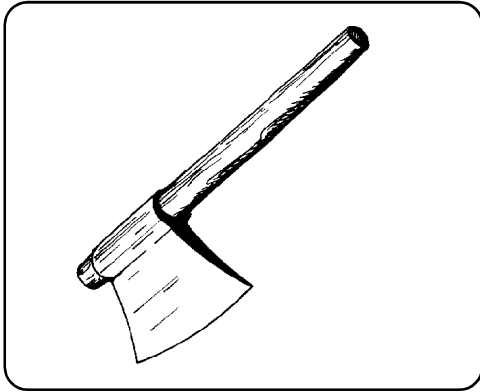

ha\_\_\_\_\_

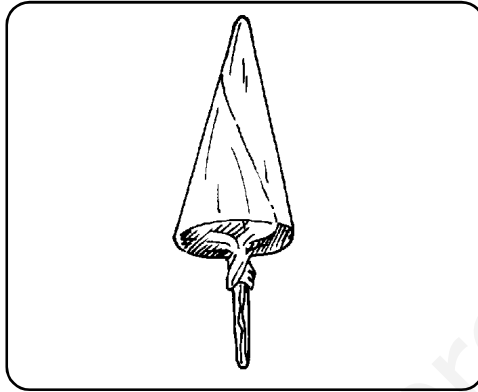

\_\_\_\_\_pete

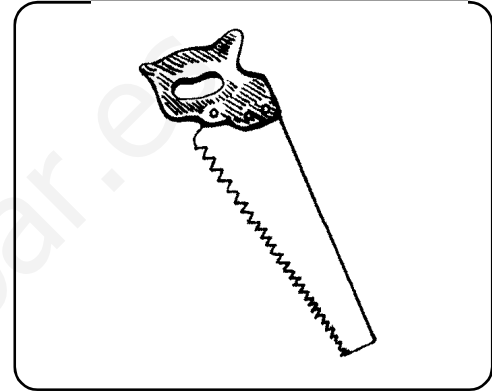

serru\_\_\_\_\_

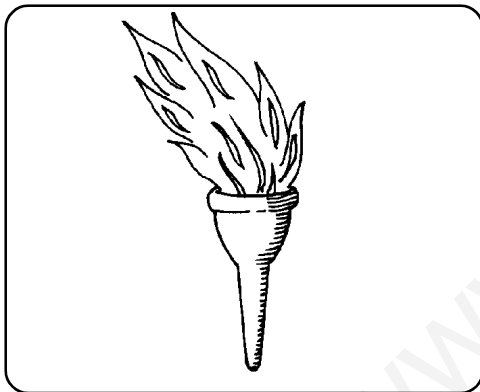

antor\_\_\_\_\_

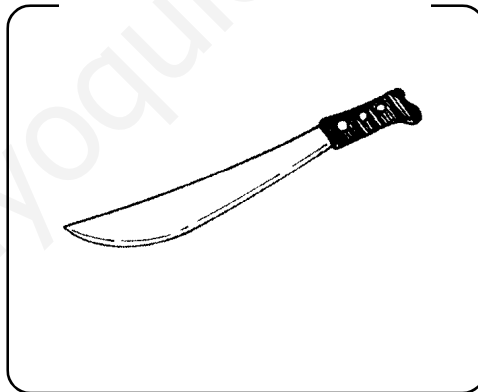

ma\_\_\_\_\_te

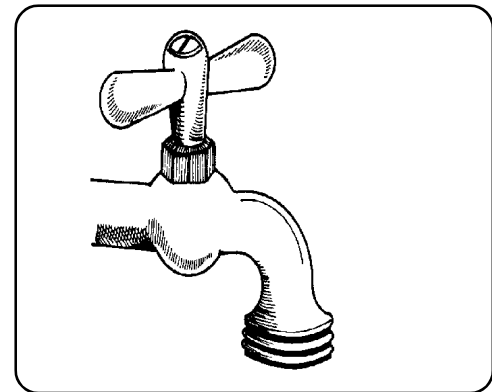

\_\_\_\_\_rro



Chalo fue a la feria de Chuarrancho, se fue en carro con Checha, también iba Chela. Comieron churros, chicharrones con chile, chuchitos y tamalitos de chipilín. Además bailaron toda la tarde con la marimba Chapinlandia. ¡La pasaron contentos!

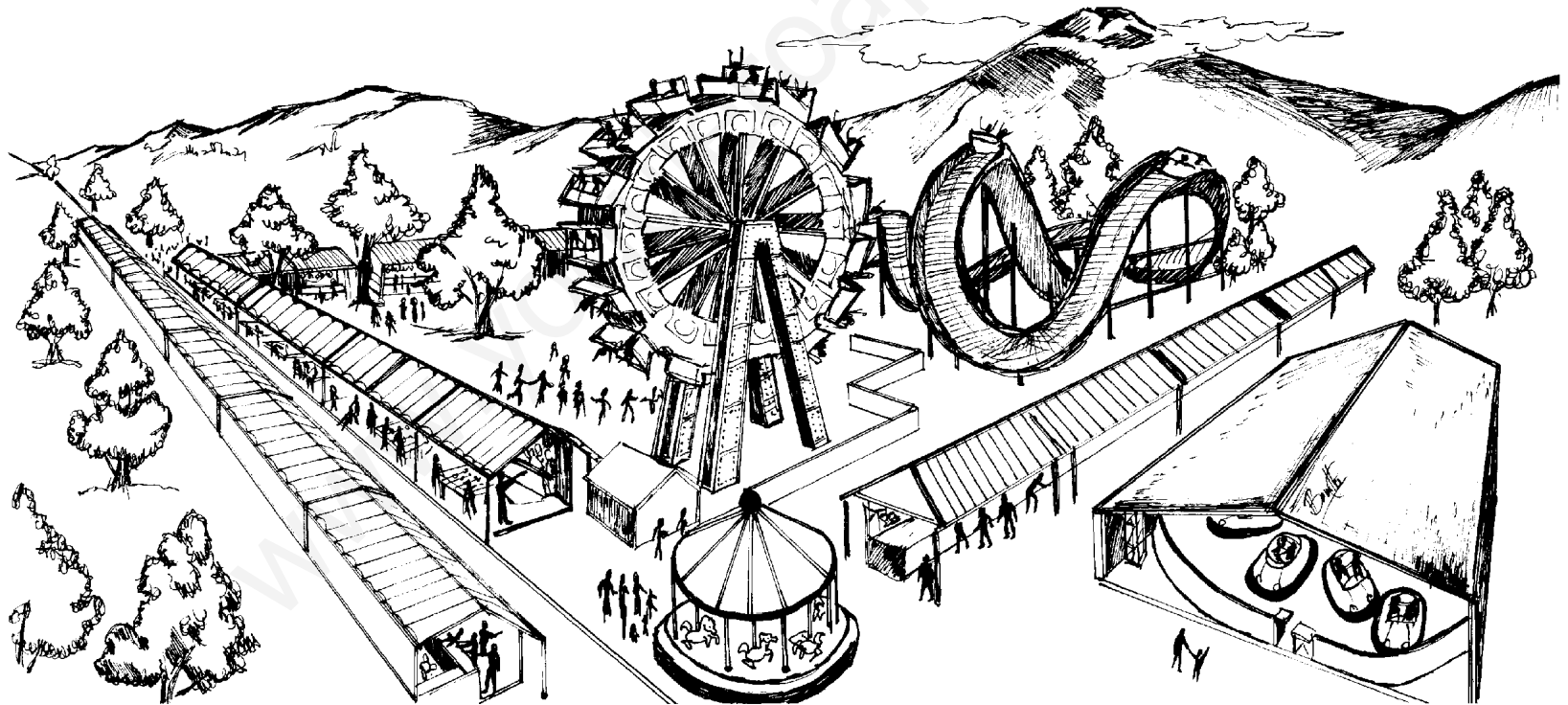



calle

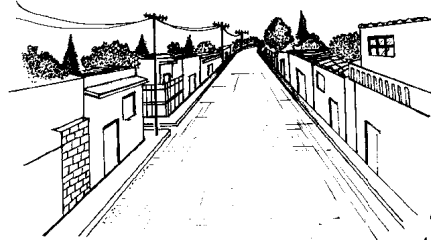

lluvia

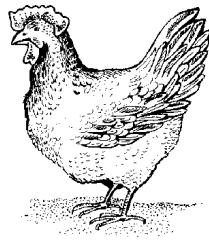

gallina



llave

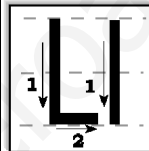
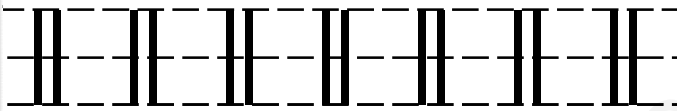
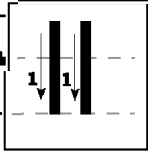

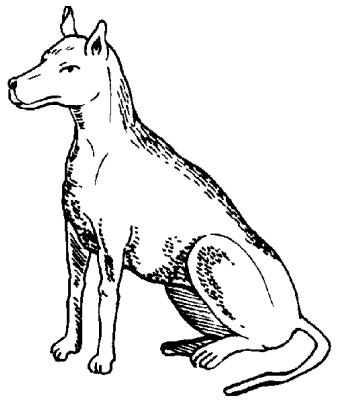
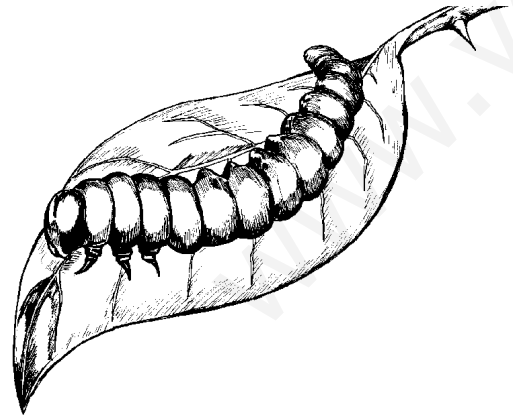
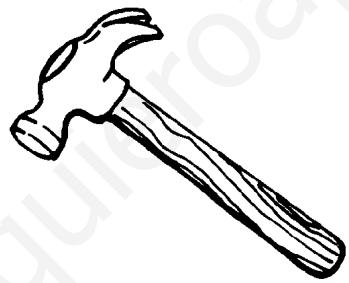
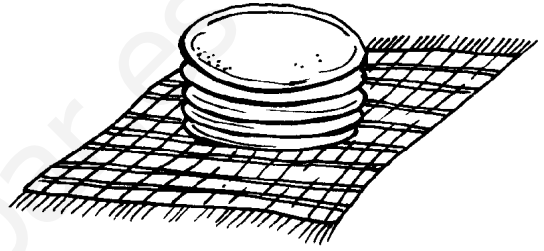
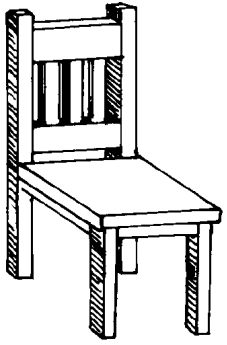
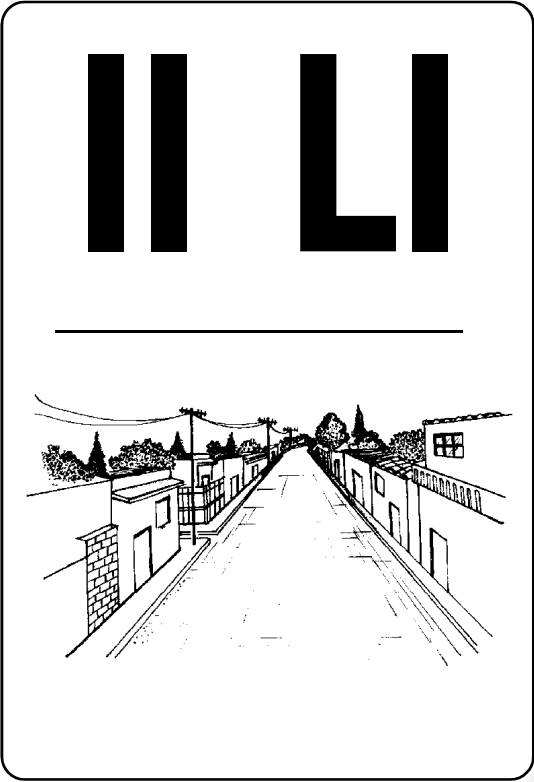
calle  
ca lle  
c a ll e  
ca lle  
calle

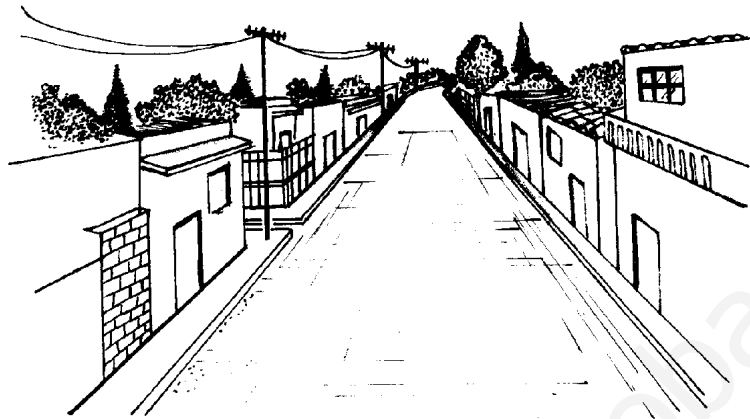

ll  
o  
a  
e  
u  
i

llo  
lla  
lle  
llu  
lli

olla

tortilla

pollo

caballo

llorar

carretilla

callar

martillo

salpullido

anillo

palomilla

silla

Las calles son útiles; en ellas pasan carros, carretas, personas, por ello; debemos mantenerlas limpias. Pasemos las calles con mucho cuidado.

Pocos caballos pasan por las calles de la ciudad.

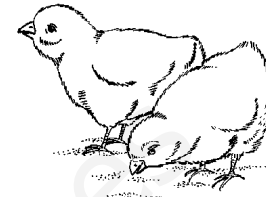

La gallina cuida mucho a sus  
La gallina cuida mucho a sus \_\_\_\_\_.

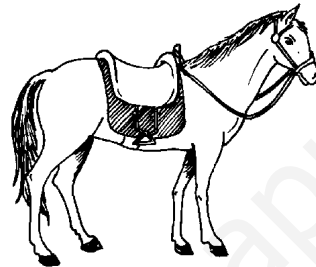

Felipe monta a  
Felipe monta a \_\_\_\_\_.

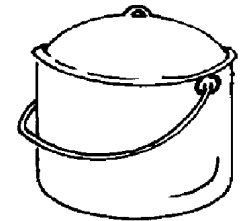

Conchita puso carne de carnero en la  
Conchita puso carne de carnero en la \_\_\_\_\_.

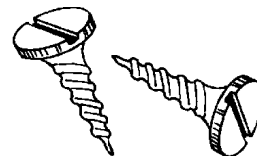

Arturo perdió los  
Arturo perdió los \_\_\_\_\_.



María cuida mucho a los pollitos. Ella les limpia el corral.

También les da de comer. En la noche, los mete al nido, así la gallina los calienta.

La basura contamina el ambiente. No debemos tirarla en las calles.

Colabore manteniéndolas limpias. Tire la basura en un basurero.



v v

vaca

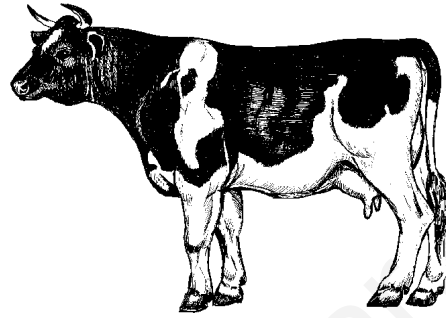

volcán



venado

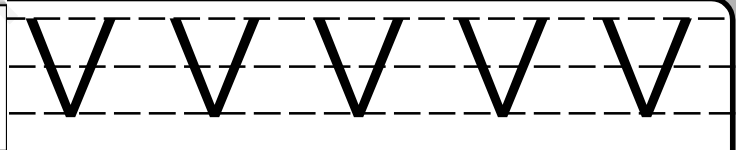
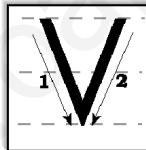
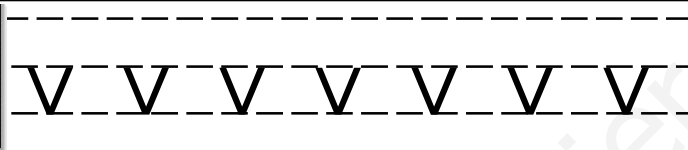
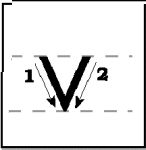
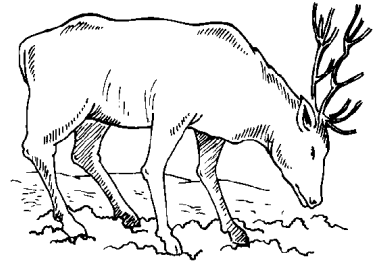

vaca  
va ca  
v a c a  
va ca  
vaca

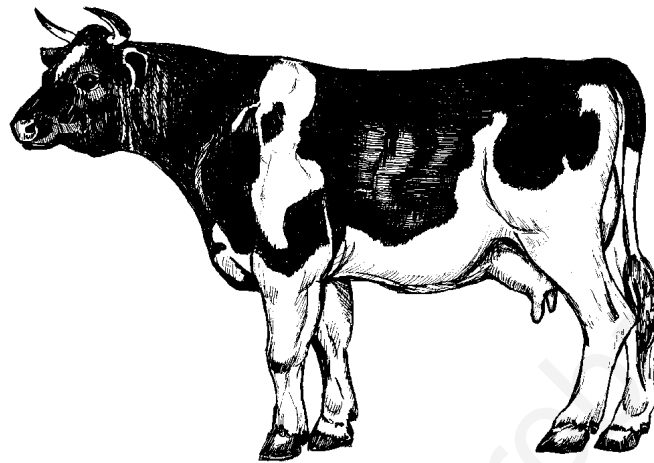

v o  
i  
a  
u  
e

vo  
vi  
va  
vu  
ve

vida

pavo

vivir

vino

vestido

ver

vela

viento

Víctor

Violeta

vivienda

vuela

La vaca es un animal doméstico.

Nos da buena leche para estar sanos.

De ella se usa el cuero, también se come su carne.

Además nos da abono.



lla \_\_\_\_\_



u \_\_\_\_\_

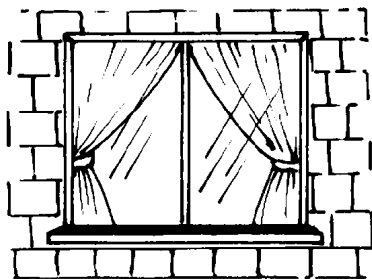

\_\_\_\_\_ tana

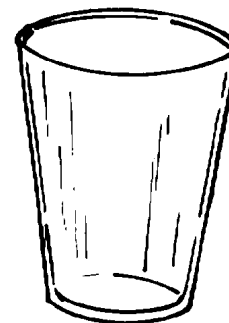

\_\_\_\_\_ so



\_\_\_\_\_ tido

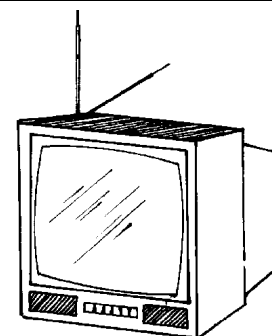

tele \_\_\_\_\_ sor



Víctor tiene una venta de \_\_\_\_\_.

vestidos

vista

dedos

Carmen \_\_\_\_\_ en Chiché.

ventana

vive

vena

Ernesto come \_\_\_\_\_.

lluvia

llaves

uvas

Camila \_\_\_\_\_ las papas.

lava

pavo

vaca



s	o	p	r	s	x	y	m	l	h	i	t	o	p	n
t	o	i	a	p	l	m	f	k	e	p	h	t	o	r
o	b	n	e	b	c	a	d	l	h	s	m	i		s
t	r	o	i	h	n	j	a	b	ó	n			e	t
o	v	d	n	a	s	b	a	i				s		n
n	r	s	t	e	b	l	ch				a	f	o	a
i	w	c	h	i	l	e	f	s	n	m	p			r
c	f	e	i	e	l	h	t	f	a	s	l	o	t	e
a	t	l	e	b	s	c	m	v	r	e	d	c	u	v
p	s	b	j	t	e	d	o	m	i	n	ó	r	b	s
á	u	f	n	v	m	s	t	a	u	s	f	n	l	e
n	w	s	d	p	e	e	o	d	a	n	e	v	s	p

0.

**Sonia**

1.

2.

3.

4.

5.

6.

7.

8.

9.

10.

gG

gusano

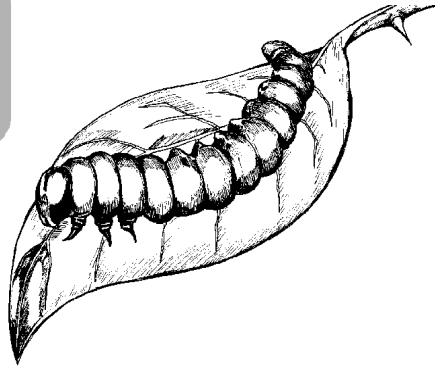

mango

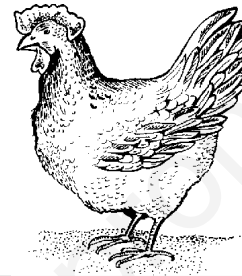
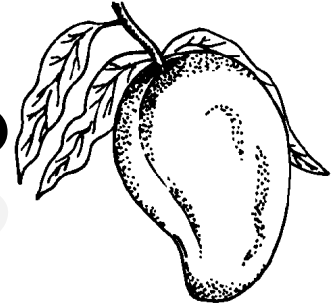

gallina



g g g g g g g g



G G G G G

gusano  
gu sa no  
g u s a n o  
gu sa no  
gusano



g a  
o  
u

ga  
go  
gu

ganado

gusto

gotera

ganso

garra

gota

riego

soga

gato

garganta

Algunos gusanos son malos para los cultivos.

El gusano cogollero ataca a la milpa.

El gusano de seda es útil para elaborar telas.



ga  
Ga

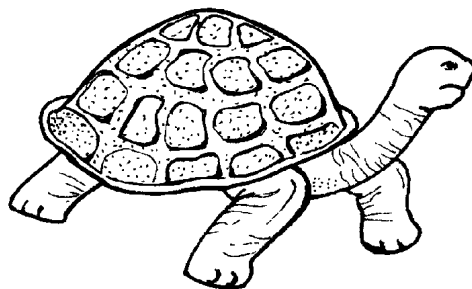

tortu\_\_\_\_\_

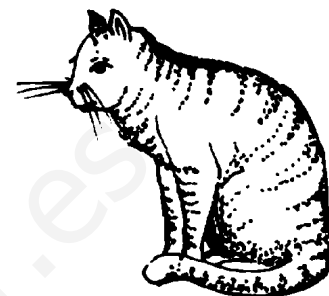

\_\_\_\_\_to

go  
Go

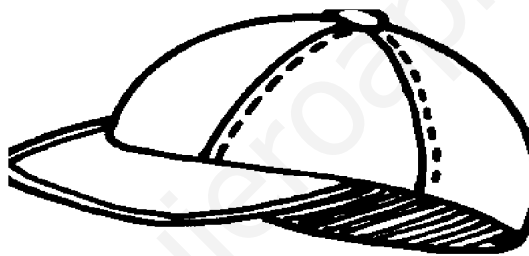

\_\_\_\_\_rra



bi\_\_\_\_\_te

gu  
Gu



\_\_\_\_\_saño

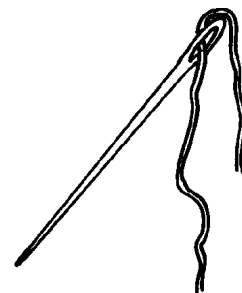

a\_\_\_\_\_ja



Yo vivo en Guatemala.

Guatemala es mi país, está conformado por veintidós departamentos.

En algunos departamentos se cultivan muchas verduras que se envían para venderlas en la ciudad capital.

¡Cuidemos y amemos a Guatemala!



ñ Ñ

niño



piña

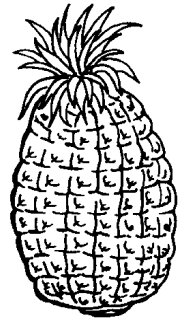

muñeca

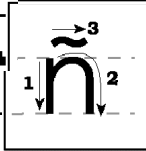

ñ ñ ñ ñ ñ ñ ñ



Ñ Ñ Ñ Ñ

niño  
ni ño  
n i ñ o  
ni ño  
niño



ñ  
o  
e  
a  
u  
i

ño  
ñe  
ña  
ñu  
ñi



niña

mañana

moña

araña

leño

montaña

albañil

teñir

sueño

peña

año

piña

Los niños son seres con sentimientos.

Todos los niños deben tener un lugar donde vivir.

Al niño como a la niña se le debe cuidar con mucho amor.

Los niños son el futuro de Guatemala.



niño

niña

año

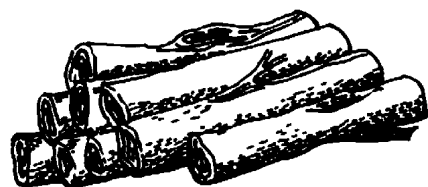

cabaña

leña

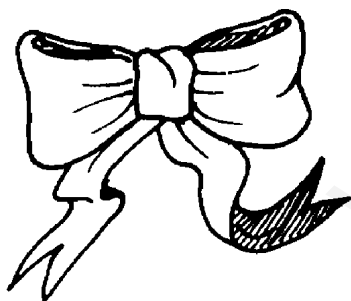

puño

moña

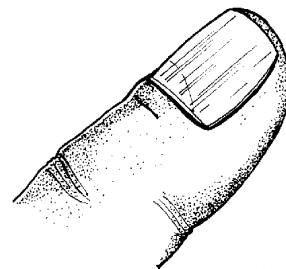

piña

caña

uña

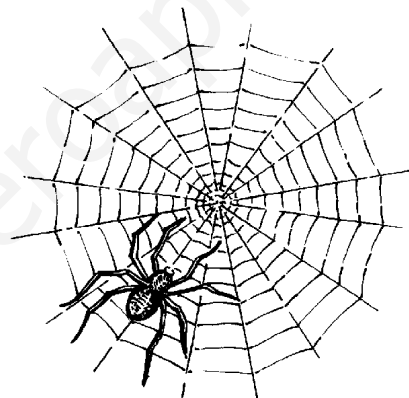

baño

pañuelo

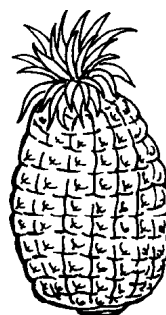





pañal

araña

**EVALUACION DE PROCESO**

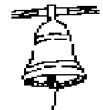
**NOMBRE:** \_\_\_\_\_ **FECHA:** \_\_\_\_\_ **LE - 2**

1		camioneta comodo casita
		decal delanta demorar
		cosecha compenrio camino
		dado duca decc

2

A Roberto le gusta la \_\_\_\_\_ caliente.  
agua      café      leche

La \_\_\_\_\_ nos da leche.  
mula      vaca      gallina

Berta come un \_\_\_\_\_.  
gato      banano      chuchitos.

La \_\_\_\_\_ es bueno para la cosecha.  
abono      lluvia      remolacha

Ernesto acarrea tierra con la \_\_\_\_\_.  
carretilla      cuchilla      piocha

3

El \_\_\_\_\_ come rotones.

Verónica cortó una \_\_\_\_\_.

Checo te le da comida al \_\_\_\_\_.

La niña usa una \_\_\_\_\_ en el pelo.





4

... DICTADO ...

---

---

---

---

---

---

---

---

jJ

jabór

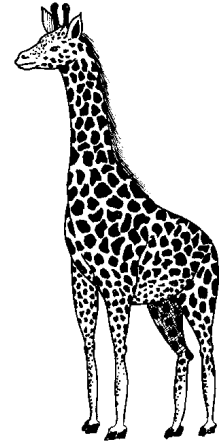

ojo

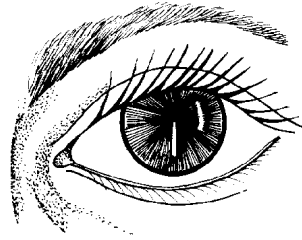

jirafa

 j j j j j j j j	J J J J J J J



زج

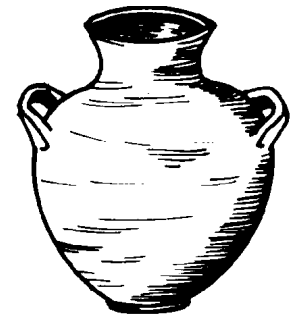
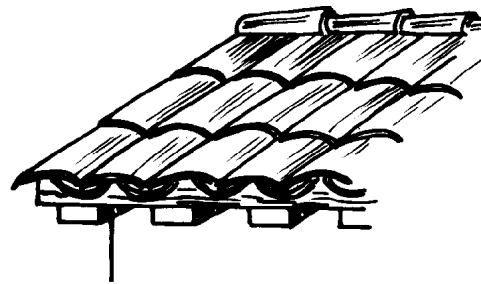
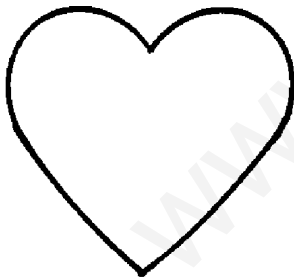
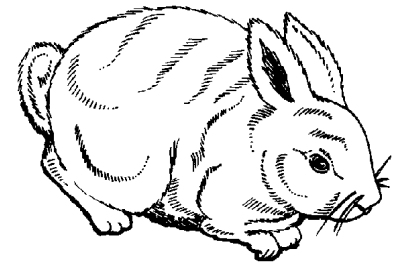
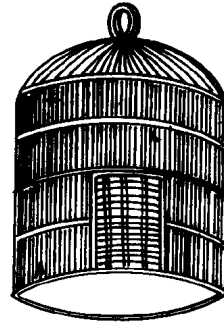

jabón  
 ja bón  
 j a b ó n  
 ja bón  
 jabón

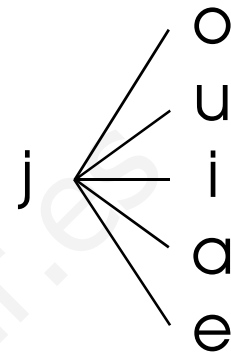

jo  
 ju  
 ji  
 ja  
 je

junio

julio

gorgojo

Javier

ajo

navaja

lagartija

piojo

naranja

joven

jefe

Jutiapa

José se baña con jabón de olor.  
 Juana enjabona la ropa de Javier.

Los jóvenes de Jocotenango se dedican a mantener limpias las calles.

Jutiapa es un departamento que se dedica a la venta de bonitas botas de cuero.





El domingo Juan fue a la fiesta de San Julián con su tía Josefina. Allí comieron jocotes, champurradas con ajonjolí. También tomaron jugo de piña. Juan llevó una jaula con dos pajaritos para su esposa Juana. A ellos les gusta ir juntos a las ferias de las aldeas.

¡Estuvieron contentos!

¿A dónde fue Juan con su tía Josefina? \_\_\_\_\_

¿Dónde comieron jocotes? \_\_\_\_\_

¿A dónde les gusta ir juntos? \_\_\_\_\_

¿Cuál bebida tomaron? \_\_\_\_\_

¿Cómo se llama la esposa de Juan? \_\_\_\_\_

zZ

zapato

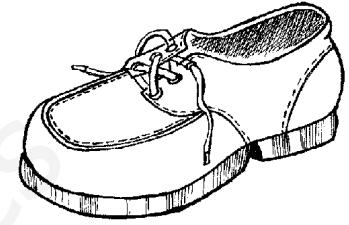

azadón



zancudo

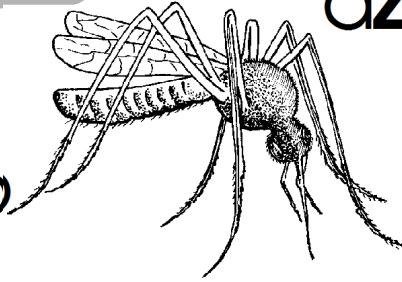

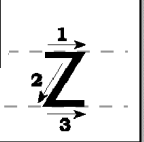
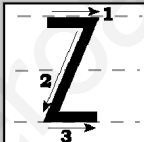
 	z z z z z z z z		Z Z Z Z Z Z Z

zancudo  
 zan cu do  
 z a n c u d o  
 zan cu do  
 zancudo

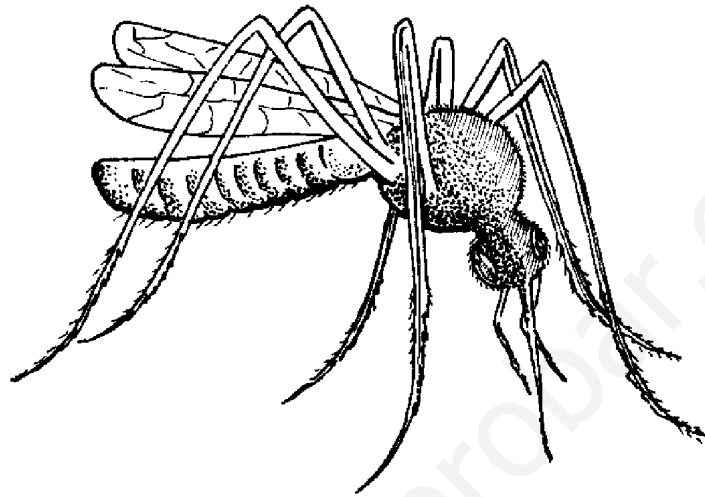

z — a  
 — e  
 — i  
 — o  
 — u

za  
 ze  
 zi  
 zo  
 zu



zapote

zopilote

zona

zorro

maíz

zanja

azúcar

Zoila

zompopo

zacate

arroz

zumو

El zancudo es un insecto dañino para la salud de las personas. Cuando nos pica un zancudo nos puede dar paludismo. Mantengamos la casa sin agua reposada para evitar zancudos.



# Algunos lugares de Guatemala

Zacapa

Patzité

Panzós

Zaculeu

Zaragoza

Verapaz

Estanzuela

Guazacapán

Izabal

Zunil

Jérez

Itzapa

Zacualpa

Morazán

Cotzal

yY

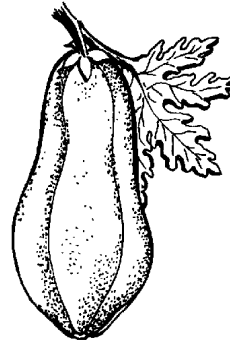

papaya

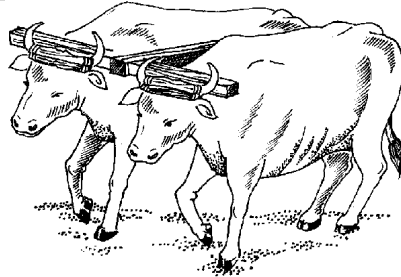

yunta



ayote

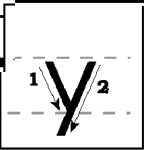

y y y y y y y

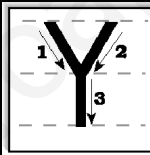

Y Y Y Y Y Y

papaya  
pa pa ya  
p a p a y a  
pa pa ya  
papaya

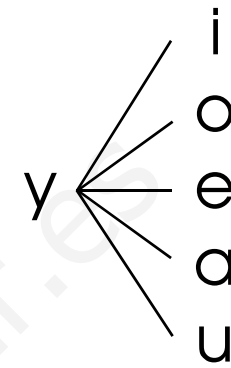
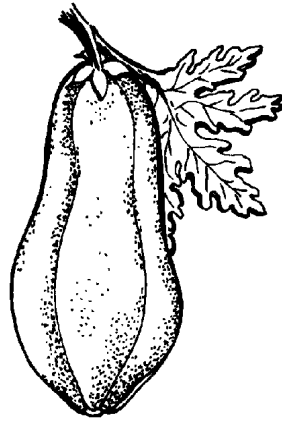

yi  
yo  
ye  
ya  
yu

yuca

yema

yerba

yeso

yoyo

Yolanda

royo

payaso

suyo

desayuno

yegua

yodo

La papaya es buena para la digestión.

Yo como papaya en el desayuno.

Ayer comí también ayote, yuca y zapote.

Yolanda trajo del mercado pacayas y papaya para el almuerzo



Los \_\_\_\_\_ fueron muy sabios.

yervas

mayas

yemas

La yunta de \_\_\_\_\_ camina por el campo.

bueyes

caballos

conejos

A Nayo le gusta comer \_\_\_\_\_.

yodo

yeso

papaya



# El maíz

El maíz es un alimento de consumo diario en todas las familias. Se usa para elaborar tortillas, tamales, chuchitos y atoles. Es muy importante en la dieta familiar.

El maíz se cultiva en todos los lugares de Guatemala. Sin embargo para tener una mejor cosecha, se aconseja variar los cultivos y así evitar el desgaste de la tierra y de sus minerales.

El maíz se consume en la familia \_\_\_\_\_.

sólo el domingo

todos los días

Para los guatemaltecos el maíz no \_\_\_\_\_ en su comida diaria

es necesario

debe faltar

El maíz se consume en la familia \_\_\_\_\_.

sólo en el calor

en diferentes climas



q Q

queso

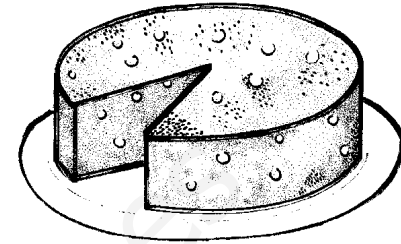

quetzal

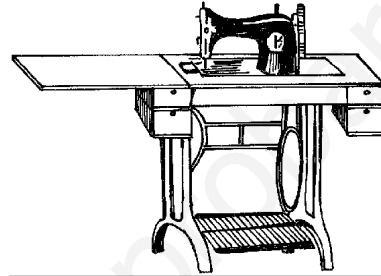

máquina



1 q 2

ue qui que qui

1 Q 2

ue Qui Que Qui

queso  
que so  
q u e s o  
que so  
queso

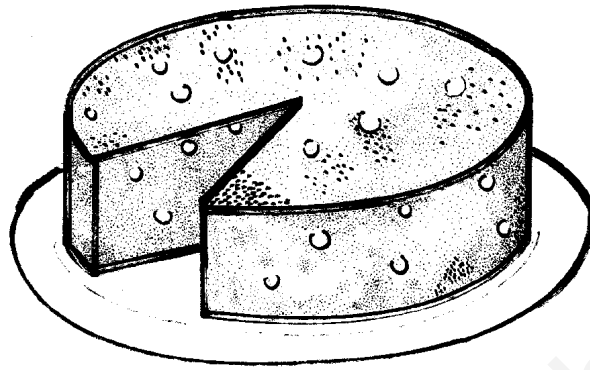

qu  $\left\{ \begin{array}{l} e \\ i \end{array} \right.$  que  
qui

quemar	mosquito
pequeño	Chiquimula
Quique	piquete
banquito	quemada
quetzal	queja
tanque	parque

En Chiquimula venden buen queso. El queso de capas se derrite rápido en el fuego. A Quique le gusta comer tortillas con queso duro. Que rico es comer requeson en el desayuno. En la tienda de doña Queta venden buen queso los días lunes.



Mi abuelito se llama Enrique. Él vive en Quiché. Yo lo visito una vez al año. Me voy

en la  \_\_\_\_\_ Veloz Quichelense.

En su  \_\_\_\_\_ tiene una 

\_\_\_\_\_ que le da buena leche, 

\_\_\_\_\_ y mantequilla. También tiene un

 \_\_\_\_\_ que es muy manso y me

deja montarlo.

Me gusta mucho visitar a mi abuelito.

hH

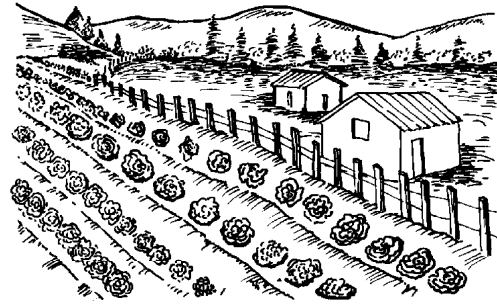

hortaliza

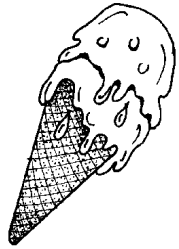

helado



hacha

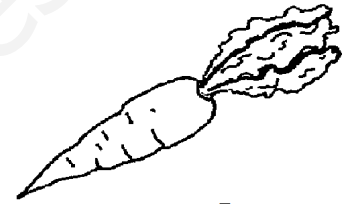

zanahoria

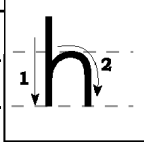
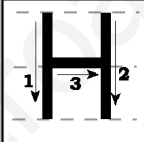
  h h h h h h	 H H H H H H

hortaliza  
hor ta li za  
h o r t a l i z a  
hor ta li za  
hortaliza

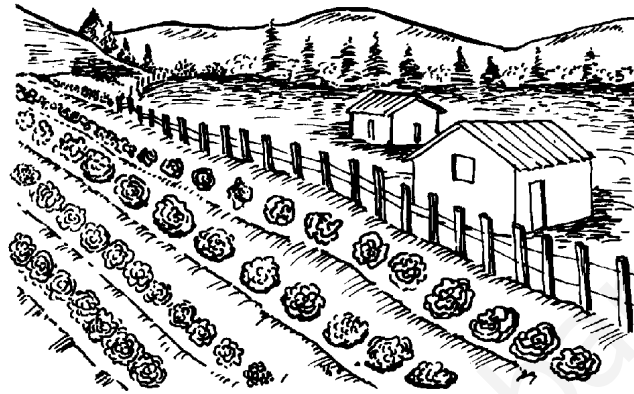

h

- i
- u
- a
- e
- o

hi  
hu  
ha  
he  
ho



hoja

hijo

hamaca

hule

higo

hormiga

honda

humo

haba

hilo

hielo

Humberto

Mi hermano Hugo cuida la hortaliza.

Él cultiva zanahorias, lechugas y rábanos.

Humberto y su hijo comen verduras en el almuerzo.

Héctor viaja a Huehuetenango los días viernes para vender sus repollos y habas.

# Las hortalizas

Las hortalizas son verduras que nos sirven de alimento. La zanahoria es rica en vitamina "A", y ayuda a tener una buena vista. La lechuga sirve para los nervios y la digestión. La espinaca contiene hierro que evita la anemia. Las hortalizas ayudan a tener buena salud. Debemos comerlas diariamente. Es importante regar las hortalizas con agua no contaminada; así evitamos enfermedades.

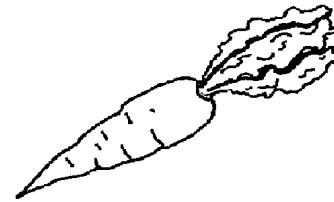

---



---



---

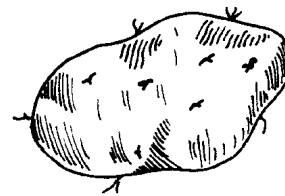

---

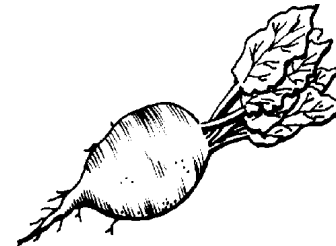

---

ce Ce

ci Ci

cerdo

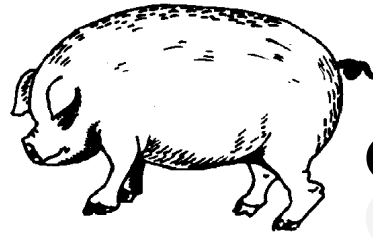

cepillo



bicicleta

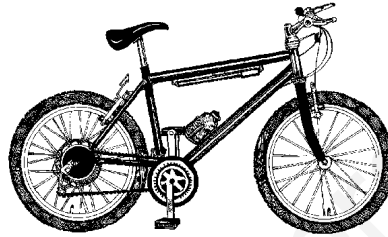

maceta



ce ci ce ci ce

Ce Ci Ce Ci Ce

cerdo  
cer do  
c e r d o  
cer do  
cerdo

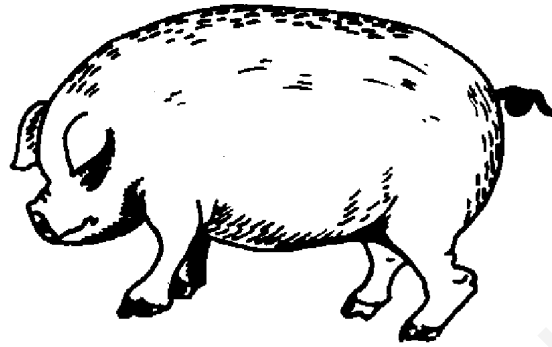

c < e ce  
i ci

cebolla

cielo

insecticida

cereza

cincho

ciruela

cebada

cera

cemento

cine

varicela

receta

Los cerdos viven en cochiqueras. Estas deben lavarse diariamente para evitar el mal olor, la suciedad y las enfermedades.

La carne de cerdo, debe estar bien cocida antes de comerla.





## Los animales domésticos

Los animales domésticos viven cerca de la casa que habitamos. Algunos de ellos son: la gallina, el cerdo, la vaca, el perro y el caballo. Debemos cuidarlos alimentarlos bien y darles un lugar adecuado donde puedan estar.

También hay que vacunarlos y mantenerlos limpios. Así evitaremos que se enfermen o mueran.

## El cerdo

El cerdo es un animal doméstico. Nos da su carne, cuero y cerdas.

Debemos darle alimentos limpios y cuidar que no coma basura o excremento, para que no se le pasen enfermedades y su carne esté sana. La carne de cerdo que está sana se puede comer con seguridad.

No debemos olvidar cocinarla bien.

ge Ge  
gi Gi



ar**ge**ño



**gi**rasol



ge gi ge gi ge	Ge Gi Ge Gi Ge

ar ge ño  
 ar ge ño  
 a r g e ñ o  
 ar ge ño  
 ar ge ño



ar**ge**ño

g < e ge  
 i gi



gente

gigante

geranio

general

girar

Argentina

gemelo

gemir

giro

Genaro

girasol

Argelia

Gerardo y Gilda son hermanos gemelos.

Ellos cultivan maíz, papa y vegetales.

Deben cuidar el maíz y la papa para evitar que se argeñen. El argeño les hace daño a las hojas y no deja que se desarrollen.

Los cultivos se pueden contagiar por el viento y los insectos.



## La gallina ciega

La gallina ciega es un gusano gordo y arrugado conocido también como oruga. Vive en el interior del suelo y se alimenta de las raíces de los cultivos.

La gallina ciega nace de los ronrones de mayo.

Una manera de terminar con los ronrones es fumigar los terrenos para así evitar que pongan huevos y nazcan las gallinas ciegas.

A los ronrones les gusta la luz de las lámparas, fogatas, candelas, candiles y bombillas.

Eliminemos a los ronrones de mayo, así las cosechas serán buenas y abundantes.

gue Gue

gui Gui

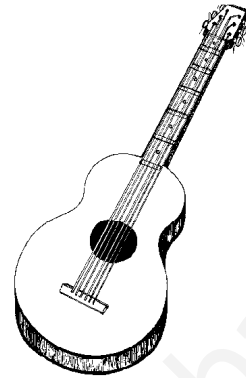

guitarra

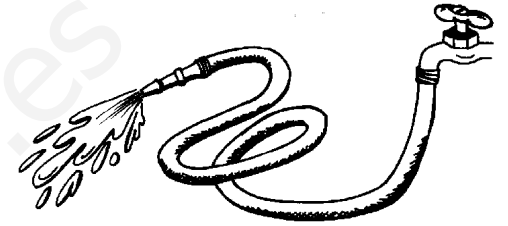

manguera



gue gui gue gui

Gue Gui Gue Gui

guitarra  
gui ta rra  
g u i t a r r a  
gui ta rra  
guitarra

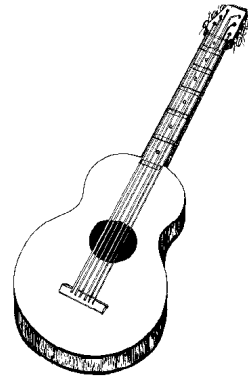

g  $\left\{ \begin{array}{l} ue \\ ui \end{array} \right.$  gue  
gui

**guitarra**

guerrero

Guillermo

juguete

dengue

guisado

guitarra

guerra

guía

maguey

higuera

Lucas toca la guitarra.

A sus amigos les gusta cantar acompañados por Lucas y su guitarra.

Hay guitarras hechas con madera y otras con metal.

¿Sabe usted tocar la guitarra?

güe Güe

güi Güi



güipil

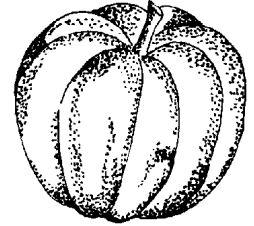

güicoy

güe güi güe güi

Güe Güi Güe Güi

güipil  
 güi pil  
 g ü i p i l  
 güi pil  
 güipil



**güipil**

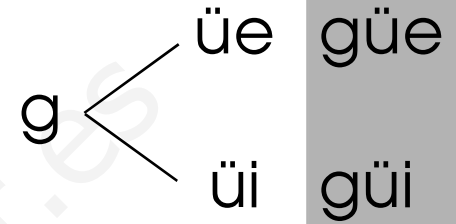

güicoy

desagüe

antigüeño

cigüeña

güegüecho

agüita

güisquil

bilingüe

agüero

Güicho

El güipil lo usan algunas mujeres indígenas en las diferentes regiones de Guatemala.

La mayoría los hacen en telares manuales. Los güipiles son muy llamativos por sus vistosos colores y sus hermosos bordados.





blusa  
blu sa  
b l u s a  
blu sa  
blusa



bl u  
a  
i  
e  
o

blu  
bla  
bli  
ble  
blo

tabla

Biblia

bledo

bloque

pueblo

cable

mueble

doblar

temblor

establo

La blusa de Blanca se la regaló su abuelita Carmela. Ella tiene blusas de algodón, de lana y de seda.

Le gusta usar sus blusas con faldas y con pantalones.

Sus blusas blancas las lava con mucho cuidado.

brocha  
bro cha  
b r o c h a  
bro cha  
brocha



br  
o  
i  
u  
e  
a

bro  
bri  
bru  
bre  
bra



lombriz

brazo

brujo

cabra

pobre

bronquitis

brasa

brisa

culebra

brillo

Braulio pinta su casa con una brocha nueva.

La brocha es de pelo de vaca. Él lava la brocha al terminar de pintar.

En la ferretería hay brochas de diferentes tamaños.

Bruno visita la fábrica de muebles en San Juan Ostuncalco.

bicicleta  
bi ci cle ta  
b i c i c l e t a  
bi ci cle ta  
bicicleta

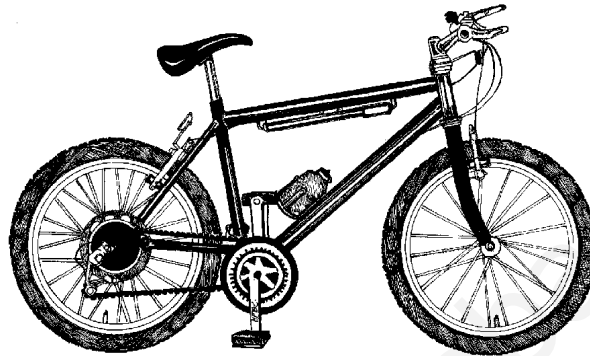

cl | e  
i  
a  
u  
o

cle  
cli  
cla  
clu  
clo

ciclista

cloro

clavo

Clemencia

clima

ciclón

clavel

Clara

clase

reclamo

Cleotilde tiene una bicicleta nueva.

Su bicicleta es de color celeste claro

A ella le gusta ver pasar a los ciclistas.

Don Clemente sabe reparar las llantas de las bicicletas y de las motocicletas

cráter  
crá ter  
c r á t e r  
crá ter  
cráter

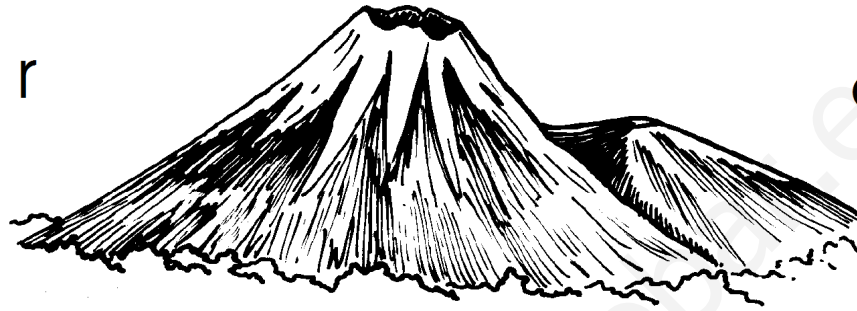

cr — a  
— e  
— i  
— o  
— u

cra  
cre  
cri  
cro  
cru



crecer

Cristóbal

cruz

crema

Jesucristo

crudo

escribir

cruel

escritorio

cráneo

El cráter es como la boca del volcán.

El volcán echa lava por el cráter.

En Guatemala hay muchos volcanes, pero pocos hacen erupción.

Pablo se puso el



\_\_\_\_\_.

Blanca abrió los

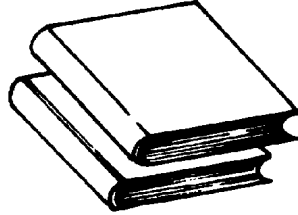

\_\_\_\_\_.

Tono rompió este

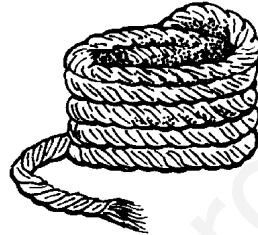

\_\_\_\_\_.

Esa

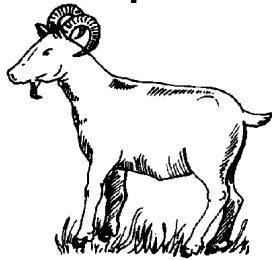

\_\_\_\_\_ come hierbas.

Esta

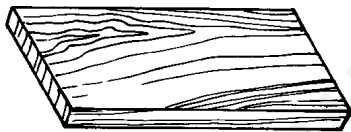

\_\_\_\_\_ esta verde.

Esos

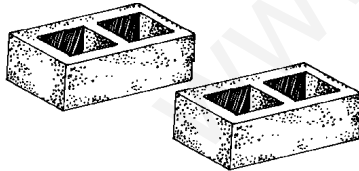

\_\_\_\_\_ son de Braulio.



Cristóbal es un carpintero. Usa buena madera

para hacer

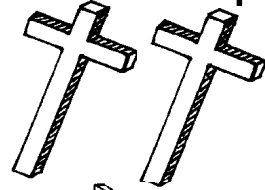

\_\_\_\_\_ y

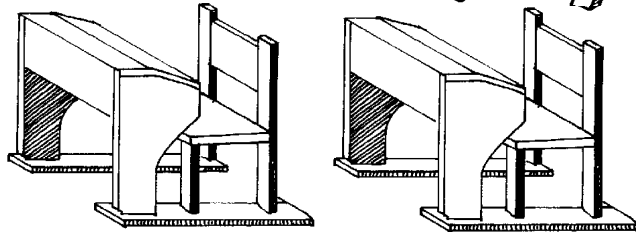

\_\_\_\_\_.

Él utiliza serrucho y

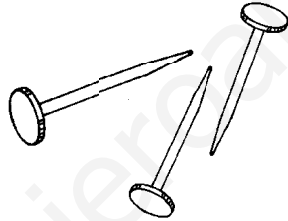

\_\_\_\_\_.

para hacer los muebles y con la

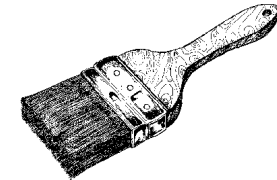

\_\_\_\_\_ pintarlos de colores.

Cuando saca la madera, tiene cuidado para

que no lo pique un



\_\_\_\_\_.

**EVALUACION DE PROCESO**

**NOMBRE:** \_\_\_\_\_ **FECHA:** \_\_\_\_\_ **LE -3**

**1** En el terreno de César se cosechan zanahorias.  
¿Qué se cosecha en el terreno de César?



Genaro le regaló un cepillo a Cecilia.  
¿Qué le regaló Genaro a Cecilia?



Los gemelos son hermanos de Hugo.  
¿Quiénes son los hermanos de Hugo?



**2** Angela tiene un \_\_\_\_\_ pijá.  
gñi - gui

Juan rompió la man \_\_\_\_\_ ro.  
gñe - gue

Federico sabe tocar \_\_\_\_\_ toro.  
gñi - gui

Rodolfo destapó el cesa \_\_\_\_\_ .  
gñe - gue

Lupe cosechará muchos \_\_\_\_\_ coyes.  
gñi - gui

**3** **EL CLAVEL:**  
El clavel es tan popular como la rosa.  
Braulio labra la tierra para sembrar claveles.  
Blanca ayuda a cultivar claveles en el terreno que está  
cerca de la casa de Don Cristóbal.  
En condiciones adecuadas el cultivo del clavel se puede  
mantener durante dos o más años.  
Actualmente en Guatemala es muy difícil reconocer que  
variedad se está cultivando, ya que se han importado  
muchas clases de claveles.

**4**

1. ¿Quién labra la tierra para sembrar claveles?  
\_\_\_\_\_
2. ¿Durante qué tiempo puede mantenerse el cultivo del  
clavel?  
\_\_\_\_\_
3. ¿Quién ayuda a Braulio a cultivar claveles?  
\_\_\_\_\_



flores  
flo res  
f l o r e s  
flo res  
flores

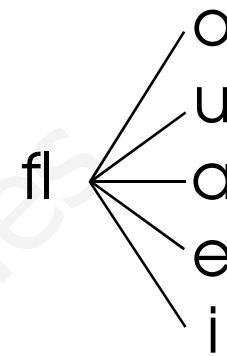

flo  
flu  
fla  
fle  
fli



flauta	fleco
rifle	flotar
flecha	flor
afloja	flaco
florecita	flema
florero	flojo

Las flores adornan las casas.  
Carlos vende flores en Antigua Guatemala.  
Floridalma recibió un ramo de flores.  
En San Juan Sacatepéquez se cultivan diferentes clases de flores.

frijol  
 fri jol  
 f r i j o l  
 fri jol  
 frijol

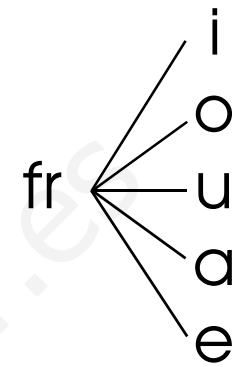
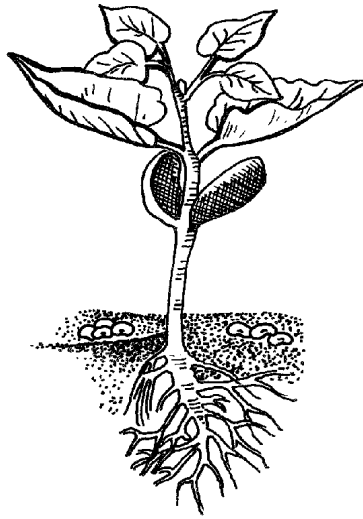

fri  
 fro  
 fru  
 fra  
 fre

fresa

cofre

frente

frasco

afrecho

frontera

fruta

frío

fresco

zafra

fritura

franja

Francisca fríe frijoles en un sartén. A su hermano Francisco le gustan los frijoles de color obscuro, a Fredy los blancos y colorados. El caldo de frijol es sabroso con pedazos de pan frito. Yo como los frijoles con queso y crema. En Parramos se siembra buen frijol.

iglesia  
 i g l e s i a  
 i g l e s i a  
 i g l e s i a  
 iglesia



gl e  
 i  
 a  
 u  
 o

gle  
 gli  
 gla  
 glu  
 glo



globo

Gloria

regla

arreglo

gladiola

siglo

glúteo

glotón

Gloria va a la iglesia el domingo.  
 Gladys asiste a una iglesia diferente.  
 En la comunidad varias iglesias las arreglan con gladiolas.  
 A Glenda le gusta una iglesia antigua que está cerca del parque.  
 En Antigua Guatemala hay muchas ruinas de iglesias que se dañaron con el terremoto.

grillo  
gri llo  
g r i l l o  
gri llo  
grillo

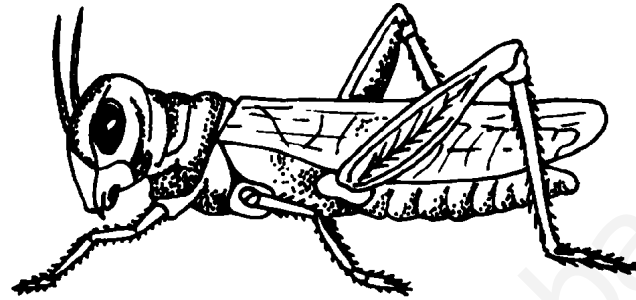

gr  
i  
o  
u  
e  
a

gri  
gro  
gru  
gre  
gra

gripe

granos

grupo

grada

grito

tigre

grande

suegro

gris

gruta

negro

cangrejo

Los grillos son animales pequeños de color café y viven entre la vegetación.

Los grillos no son dañinos a la agricultura.

Los grillos producen un fuerte sonido durante el día y la noche. A mi hermana Griselda le gusta ir al campo y escuchar a los grillos.



\_\_\_\_\_cisco es un gran a\_\_\_\_\_cultor.

Fran - Flan

gri - gli

Todos los años siem\_\_\_\_\_jol

bra - bla

fri - fli

ne \_\_\_\_\_.

gro - glo

bra - bla

También siembra \_\_\_\_\_tas como \_\_\_\_\_sas

fru - flu

fre - fle

y \_\_\_\_\_nadillas.

gra - gla

Cerca de la casa, su esposa \_\_\_\_\_ridalma

gen - guen

Fro - Flo

cultiva \_\_\_\_\_veles, \_\_\_\_\_diolas y

cra - cla

gra - gla

\_\_\_\_\_santemos.

cri - cli



Formar oraciones según la acción que representa el dibujo.



1. \_\_\_\_\_.
2. \_\_\_\_\_.



1. \_\_\_\_\_.
2. \_\_\_\_\_.



1. \_\_\_\_\_.
2. \_\_\_\_\_.

plátano  
plá ta no  
p l á t a n o  
plá ta no  
plátano

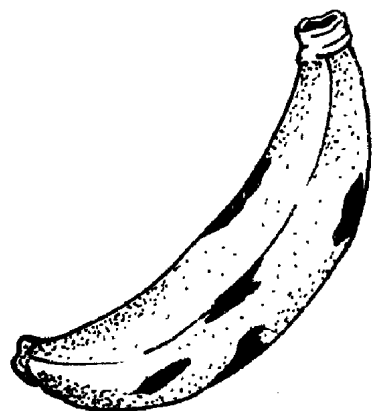

pl  
a  
e  
i  
o  
u

pla  
ple  
pli  
plo  
plu



plaga

pleito

cumplir

plomo

plástico

plaza

pluma

plato

plancha

pliego

plata

plomada

En el departamento de Izabal se cultivan plátanos muy buenos. El plátano se puede comer cocido, asado, horneado y en bebida como el atole.

Anoche Rosa hizo rellenitos de plátano con frijol y manjar para vender en la plaza, los cubrió con plástico por el polvo y las moscas.

pradera  
 pra de ra  
 p r a d e r a  
 pra de ra  
 pradera

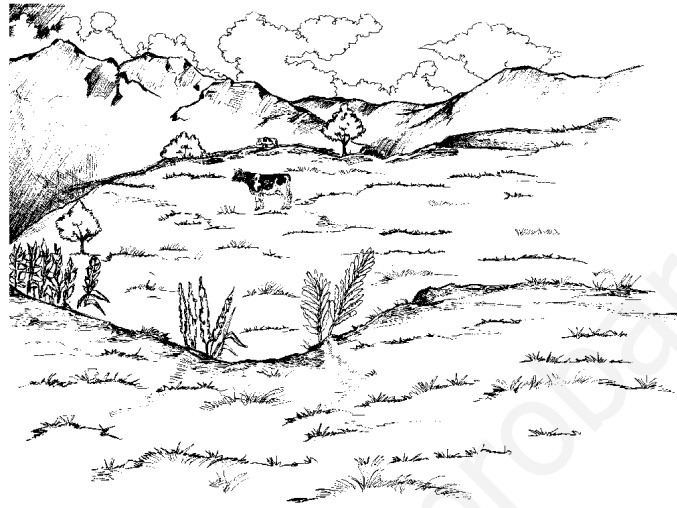

pr  
 e  
 i  
 o  
 u  
 a

pre  
 pri  
 pro  
 pru  
 pra

precio

pradera

primo

primero

comprar

imprudente

prensa

presidente

prueba

presidio

La pradera es un lugar cubierto de grama, con algunos árboles y flores. Alta Verapaz es un departamento bello por sus praderas y su clima. Angela en su pradera mantiene vacas para que le produzcan leche y luego venderla.

La pradera de Alfredo es visitada para pasear o realizar festejos.



Atitlán  
 A ti tlán  
 A t i t l á n  
 A ti tlán  
 Atitlán

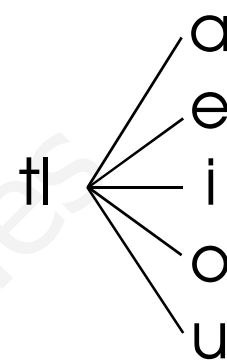
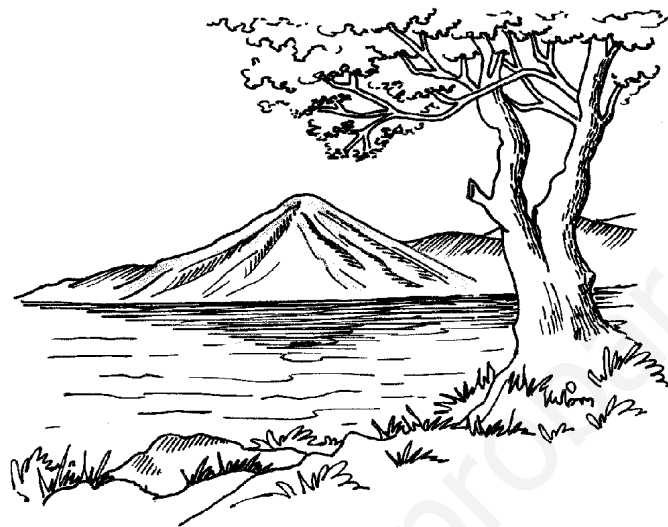

fla  
 fle  
 fli  
 flo  
 flu



Amatitlán    atletismo

Escuintla    atlas

Atlántico    atleta

amatitlaneco

escuintleco

El domingo conocí Atitlán. Es un bello lago de mi país. Se puede pasear en lancha.

Lo visitan muchos turistas.

El lago de Atitlán está rodeado por doce pueblos y dos volcanes.

trigo  
tri go  
t r i g o  
tri go  
trigo

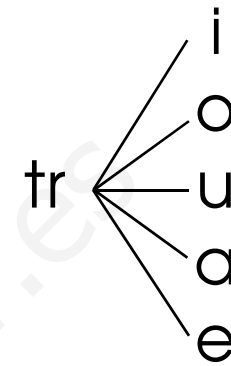

tri  
tro  
tru  
tra  
tre

metro

traje

letrina

tres

nutrición

trabajo

trampa

traso

catre

cuatro

tractor

tren

Juana y Pedro son esposos y cultivan trigo en un terreno que tienen en Totonicapán. Ellos venden la cosecha de trigo a tres fabricas que elaboran pan en Guatemala. El trigo es de mucho alimento.

piedra  
 pie dra  
 p i e d r a  
 pie dra  
 piedra

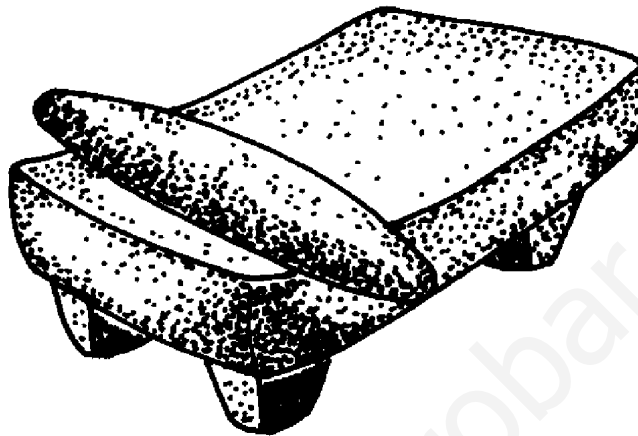

dr — i  
       o  
       u  
       a  
       e

dri  
 dro  
 dru  
 dra  
 dre



drenaje

ladrillo

vidrio

ladrar

droga

ladrón

madrugada

madrina

Pedro

padre

Juana amasa la masa en la piedra de moler.

En la piedra también se muelen especias para tamales y para algunos guisos.

Fabricio fabrica piedras de moler y Chico las vende en el mercado de Piedras Altas.



Ayer subió el \_\_\_\_\_cio del \_\_\_\_\_tano.  
pre - ple                      prá - pla

Clara tiene una \_\_\_\_\_cha eléc\_\_\_\_\_ca.  
pran - plan                      tri - tli

Juan \_\_\_\_\_baja como sas\_\_\_\_\_.  
tra - tla                      tre - tle

Se deben fumigar las \_\_\_\_\_taciones para evitar  
\_\_\_\_\_gas.  
pra - pla

Pa\_\_\_\_\_tiene un \_\_\_\_\_tor.  
bro - blo                      trac - tlac

Ese perro la\_\_\_\_\_mucho.  
dra - dla

A\_\_\_\_\_, rompió el vi\_\_\_\_\_con un la\_\_\_\_\_llo.  
drián - dlián                      drio - dlio                      dri - dli

Antonio, \_\_\_\_\_tame el me\_\_\_\_\_y la \_\_\_\_\_mada.  
prés - plés                      tlo - tro                      plo - pro

# Suelos para el cultivo del trigo

Es importante tener conocimientos de las diferentes clases de suelos que existen. Los más apropiados para el cultivo del trigo son los suelos francos. Se llaman así aquellos que tienen una mezcla adecuada

de arena y arcilla. Este tipo de suelos es ideal para la agricultura en general.. El suelo sirve a la planta para sostenerla y nutrirla de las sustancias que necesita.





Antes de sembrar el trigo ¿Qué se recomienda conocer?

---

¿Para qué sirve el suelo a las plantas?

---

¿Cómo se llama el suelo más apropiado para sembrar el trigo?

---

¿Qué mezcla de materiales contiene el suelo franco?

---

kK

kilometro

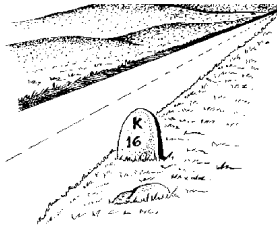

kepis

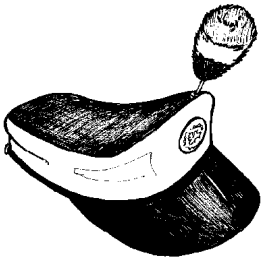

kiosco

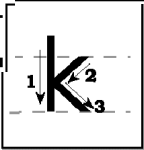
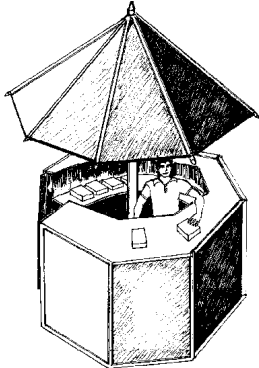

k k k k k k k

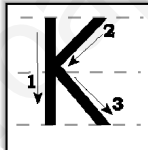

K K K K K

Handwriting practice grid with multiple rows of dashed lines for tracing and independent writing.

xx

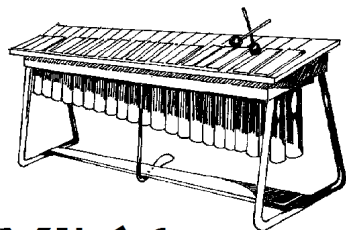

Xilófono

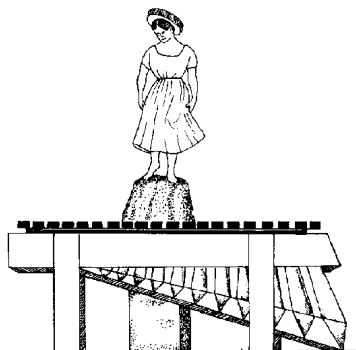

Xelajú

ww



Wendy

Wilfredo

Wenceslao

	x x		X X		w w		W W





Las carreteras se miden por kilómetros.

Un kilómetro es igual a mil metros.

Iximché fue la primera capital de Guatemala, está en Tecpán municipio de Chimaltenango.

Tikál y Kaminal Juyú fueron ciudades importantes de la cultura maya.

Wendy y Walter escuchan música folclórica.

El parque de San Marcos tiene un hermoso kiosko.



1. \_\_\_\_\_
2. \_\_\_\_\_
3. \_\_\_\_\_



1. \_\_\_\_\_
2. \_\_\_\_\_
3. \_\_\_\_\_



1. \_\_\_\_\_
2. \_\_\_\_\_
3. \_\_\_\_\_

# Los pronombres personales



Forme oraciones con los pronombres según lo que observa en el dibujo.

Yo \_\_\_\_\_

El \_\_\_\_\_

Nosotros \_\_\_\_\_

Ella \_\_\_\_\_

Ellos \_\_\_\_\_

Ustedes \_\_\_\_\_

Tú \_\_\_\_\_



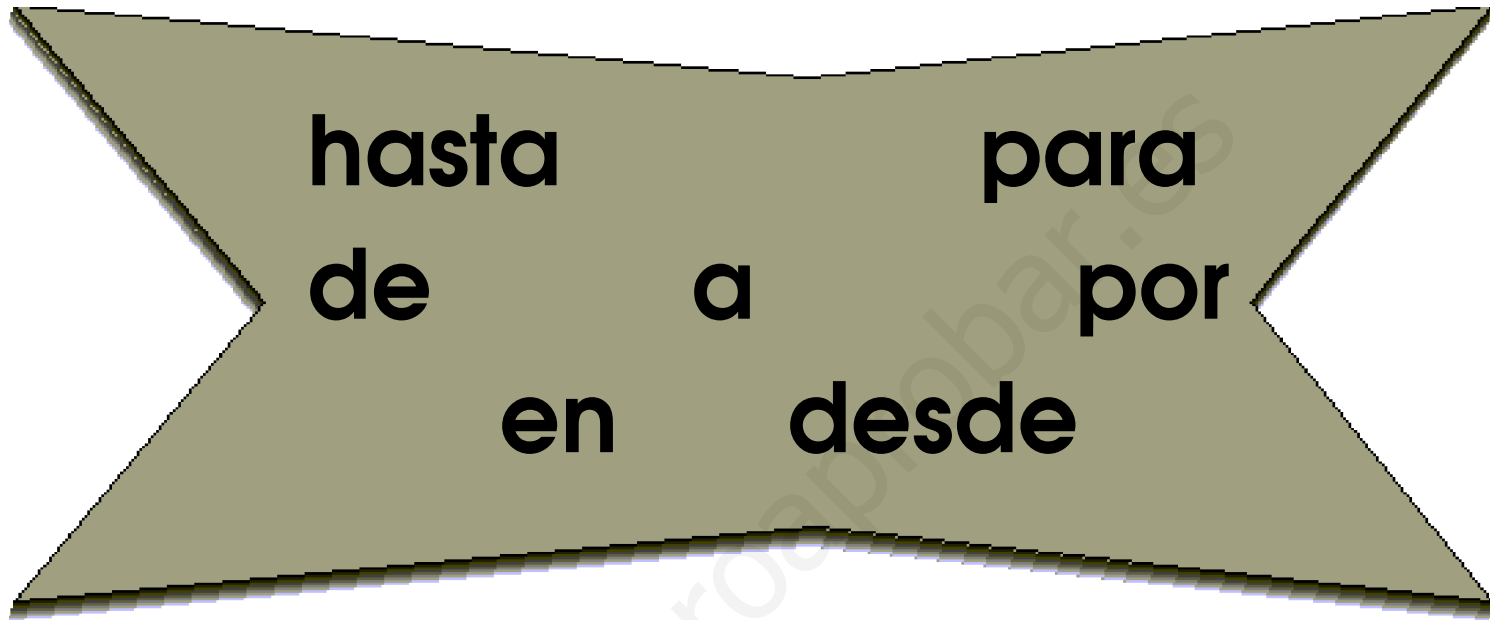

Tomasa preparó el desayuno desde  
muy temprano. Juan viajará \_\_\_\_\_ Sololá  
\_\_\_\_\_ Huehuetenango, \_\_\_\_\_  
esa ciudad asistirá \_\_\_\_\_ la feria ganadera.  
\_\_\_\_\_ esa razón no estará \_\_\_\_\_ la  
tapizca.

EVALUACION DE PROCESO

NOMBRE: \_\_\_\_\_

FECHA: \_\_\_\_\_

LE - 4

- La Familia -

La familia es el grupo de personas formado por los padres y los hijos. Además de los padres e hijos también la integran los tíos, los primos, los sobrinos y los abuelos.

Los padres tienen obligaciones que cumplir. Por ejemplo: proporcionar a los hijos vestuario, alimentación y protección. No deben explotarlos ni obligarlos a hacer trabajos inadecuados a su edad.

Asimismo, los padres tienen derechos que disfrutar, como el cariño, el respeto y la obediencia de sus hijos.

Los padres deben ser flexibles, pero también deben establecer reglas para procurar el buen comportamiento de los hijos.

Los hijos también tienen derechos y obligaciones que cumplir.

Con base a la lectura anterior conteste las siguientes preguntas:

1. ¿Quiénes integran la familia?

\_\_\_\_\_

2. ¿Cuáles son las obligaciones que tienen que cumplir los padres?

\_\_\_\_\_

3. ¿Qué derechos deben de disfrutar los padres?

\_\_\_\_\_

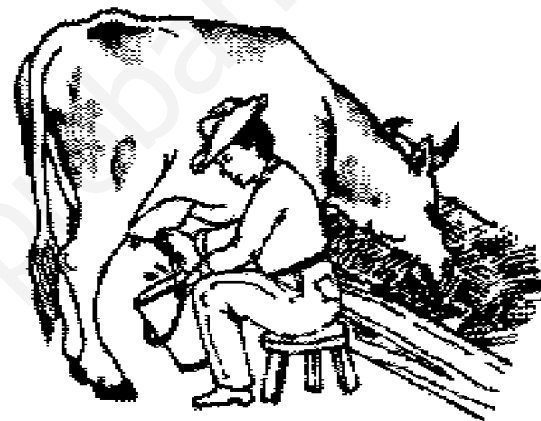

De acuerdo a lo que observa en el dibujo escriba una composición.

\_\_\_\_\_

\_\_\_\_\_

\_\_\_\_\_

\_\_\_\_\_

\_\_\_\_\_

\_\_\_\_\_

\_\_\_\_\_

# CRÉDITOS

## CUADERNO DE LECTO-ESCRITURA AÑO 2001.

Versión inicial elaborada por:	Licda. Marta Morales de Téllez
2da. validación y corrección:	Licda. Mercedes Díaz López de Sánchez
Revisión:	Héctor Ovidio Morales Ralda Olga M. Hernández de León
Diagramación:	Karla Ivette Colindres Palencia Sandra Elizabeth Marroquín Santos
Levantado de texto:	Karla Ivette Colindres Palencia Sandra Elizabeth Marroquín Santos
Ilustración:	Mayra Estrada Mazariegos de Girón Héctor Fernando Barillas Caicedo
Coordinación:	Licda. Olga Margarita Hernández de León Unidad de Investigación y Planificación
Editor:	Comité Nacional de Alfabetización -CONALFA-

## CUADERNO DE LECTO-ESCRITURA AÑO 2005.

**Licda. Ilda Morán de García**  
**Secretaria Ejecutiva**  
**Entidad Ejecutora**

Revisión	Unidad de Investigación y Planificación
Coordinación:	Licda. Dora Emelina Soberanis Gática Unidad de Investigación y Planificación
Diagramación y levantado de texto:	Sandra Elizabeth Marroquín Santos
Ilustración:	Mayra Estrada Mazariegos de Girón Héctor Fernando Barillas Caicedo
Editor:	Comité Nacional de Alfabetización -CONALFA-

La presente reproducción consta de 33,656 ejemplares que son de distribución gratuita por el Comité Nacional de Alfabetización -CONALFA-

Guatemala, marzo 2007.