

Name

ACTIVITY 1

English worksheet with the vocabulary of the summer.
wordsearch.

DRINK

SWIM

SAIL

LIE

TRAVEL



R	N	B	I	X	C	F	N
D	K	L	W	L	C	U	S
R	V	G	I	I	S	A	T
I	V	R	E	E	L	Q	E
N	D	S	W	I	M	H	L
K	S	A	I	L	M	H	O
B	F	T	R	A	V	E	L
K	I	M	R	K	W	G	R





Name

ACTIVITY 2

English worksheets with the summer.
Choose the right option.



Sailing

Swimming

trip



Seaside

Countryside

Travel



Drink

Ice-cream

Clothes



lie down

Swimming

fan



photo

fan

trip



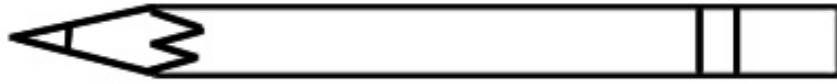

Name _____

ACTIVITY 3

English worksheet with the vocabulary of the summer.
Scramble letters
Put the letters in order to make the words.

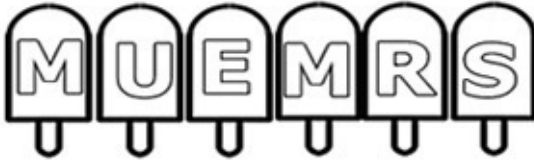

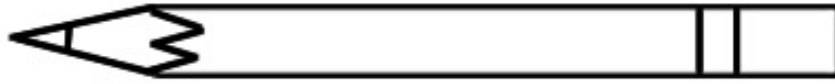

Name _____

ACTIVITY 4

English worksheet with the vocabulary of the summer.
Read and colour.

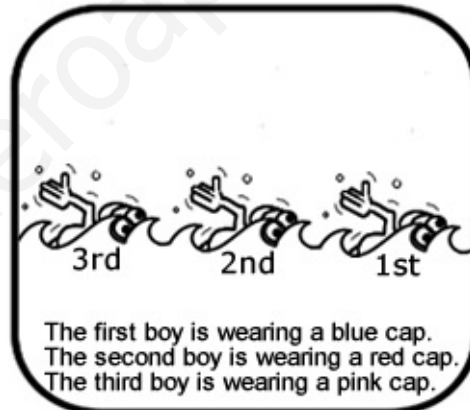



Name _____

ACTIVITY 5

English worksheet with the vocabulary of the summer.
Solve the crossword.

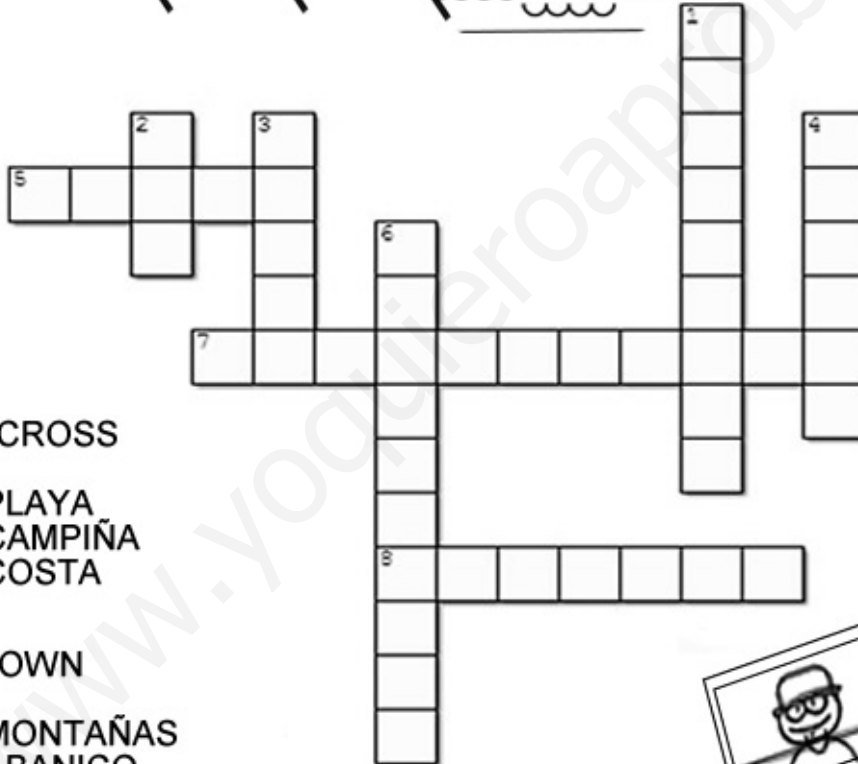
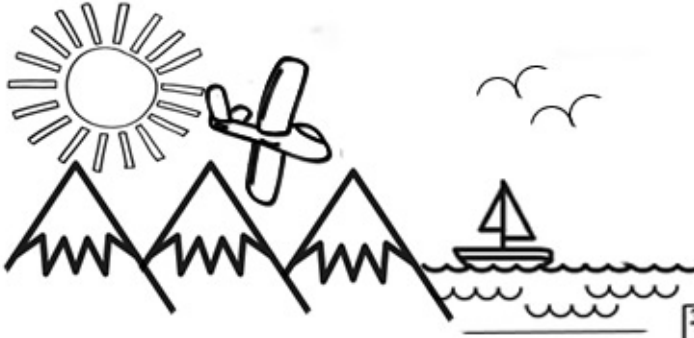

ACROSS

- 5 PLAYA
- 7 CAMPIÑA
- 8 COSTA

DOWN

- 1 MONTAÑAS
- 2 ABANICO
- 3 FOTO
- 4 VERANO
- 6 GAFAS DE SOL



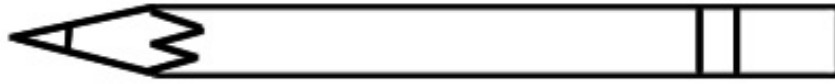

Name _____

ACTIVITY 6

English worksheet with the vocabulary of the summer.
Definitions.

Write the number of the definition on the circle.



1 Swimming



2 Ice-cream



3 Photo

A frozen food containing cream.



A picture made by a camera.



They protect your eyes from the sun.



It's for keeping you cool.



To be in a flat position on a surface.



4
Sunglasses



5
To lie down



6
Fan



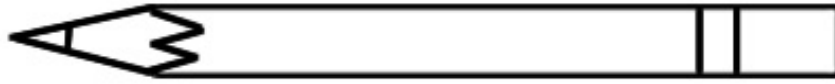

Name _____

ACTIVITY 7

English worksheet with the vocabulary of the summer.
Secret code.





Summer

It is the best time of the year
The school holidays are here.
Long warm days with no classes,
summer clothes and sunglasses.

We can go on a seaside vacation
to have fun, joy and relaxation.
We can lie down and get a tan,
enjoy the sun without a plan.

If you need to keep cool,
go for a swim in the pool.
Visit the mountains in Peru,
or take a trip on a canoe.

We can travel to the country,
Take off our shoes, run free.
It's the best time of the year.
The school holidays are here.

<http://www.theyellowpencil.com/elverano.html>

ACTIVITY 1

English worksheet with the vocabulary of the summer. Wordsearch.

- DRINK
- SWIM
- SAIL
- LIE
- TRAVEL



R N B I X C F N
 D K L W L C U S
 R V G I I S A T
 I V R E E L Q E
 N D S W I M H L
 K S A I L M H O
 B F T R A V E L
 K I M R K W G R



ACTIVITY 2

English worksheets with the summer. Choose the right option.

- Sailing
- Swimming
- Trip
- Seaside
- Countryside
- Travel
- Drink
- Ice-cream
- Clothes
- Lie down
- Swimming
- Fan
- Photo
- Fan
- Trip



ACTIVITY 3

English worksheet with the vocabulary of the summer. Scramble letters. Put the letters in order to make the words.

- IRPT Trip
- MUEMRS Summer
- OLTCHES Clothes
- HPTOO Photo
- AESDISE Seaside



ACTIVITY 4

English worksheet with the vocabulary of the summer. Read and colour.

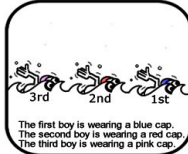

ACTIVITY 5

English worksheet with the vocabulary of the summer. Solve the crossword.

ACROSS
 5 PLAYA
 7 CAMPIÑA
 8 COSTA

DOWN
 1 MONTAÑAS
 2 ABANICO
 3 FOTO
 4 VERANO
 6 GAFAS DE SOL



ACTIVITY 6

English worksheet with the vocabulary of the summer. Definitions. Write the number of the definition on the circle.

- 1 Swimming
 - 2 Ice-cream
 - 3 Photo
- A frozen food containing cream.
- A picture made by a camera.
- They protect your eyes from the sun.
- It's for keeping you cool.
- To be in a flat position on a surface.
- 4 Sunglasses
 - 5 To lie down
 - 6 Fan

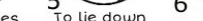

ACTIVITY 7

English worksheet with the vocabulary of the summer. Secret code.

A B C D E F G
 H I J K L M N
 O P Q R S T U V
 W X Y Z

FISH

SUMMER

TOWEL



<http://www.theyellowpencil.com/elverano.html>





BALL



BUCKET
SPADE



CAP

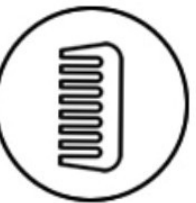

COMB



FAN

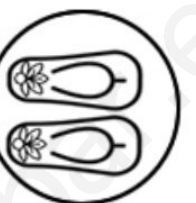

FLIPFLOPS



FLIPPERS



SUNGLASSES



ICE-CREAM
ICE-LOLLY



GOGGLES AND
SNORKLE



LEMONADE



PARASOL



SHELL



SUN-CREAM



SWIMSUIT



SWIMMING
TRUNKS



TOWEL



T-SHIRT

English activities

by the yellow pencil



SUMMER

<http://www.theyellowpencil.com/elverano.html>



Name

These things are for protecting your skin from the sun.
Find their names in the word search.



C _ _

S _ _ _ _

P _ _ _ _



S _ _ _ _



T _ _ _ _

U R J N V J P S B
 U R J N V J P S B
 E S U N . C R E A M
 V P B J Y E L O A M
 K A X M Y J D I A N
 X C S P A R A S O L
 S V T . S H I R T J
 I R H J B V N I V
 S U N G L A S S E S

1



Name

Choose the right word to name the picture.



TOWEL

FLIP FLOPS

SWIMSUIT



TOWEL

FLIP FLOPS

SWIMSUIT



TOWEL

FLIP FLOPS

SWIMSUIT



TOWEL

SWIMMING TRUNKS

SWIMSUIT



BALL

TOWEL

SWIMSUIT

2



Name

Complete these sentences with the right words.
If it's hot,

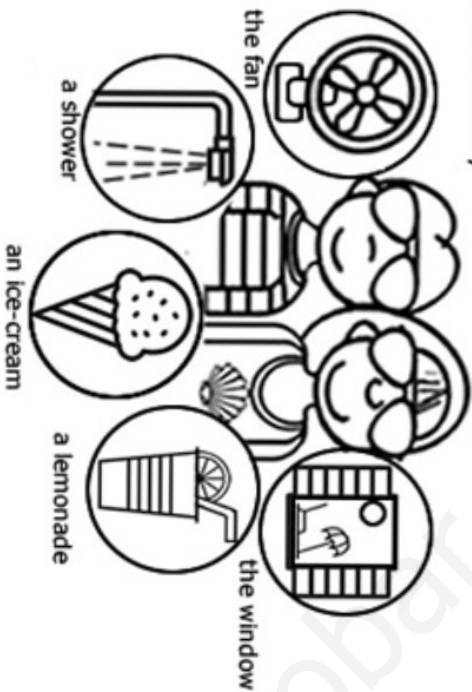

1-We can open

2-We can have

3-We can drink

4-We can eat

5-We can switch on

3



Name

Complete these sentences with the possessive adjectives

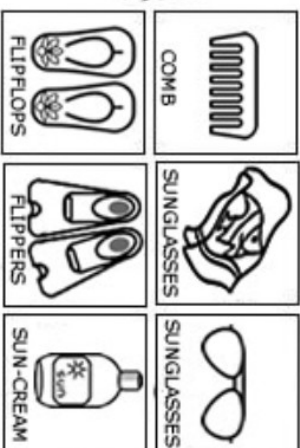

0 Mary has got a comb.

It's *her* comb.

1 The girls have got sun-cream.

It's sun-cream.

2 My brother has got sunglasses.

They're sunglasses.

3 Tom has got flippers.

They're flippers.

4 We have got flipflops.

They're flipflops.

5 I have got a towel.

It's towel.

4



Name

Read and colour



The swimming trunks are blue the shark are yellow.



The ice-cream is brown. The ice-lolly is blue.



5 The cap is black the whale is white.



The swimsuit is light pink. The flower is purple.



The snorkel is yellow and the goggles are orange.

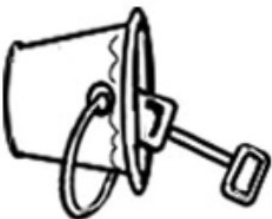

The bucket is red the spade is green.



Name

Solve the crossword with the vocabulary of the summer in English

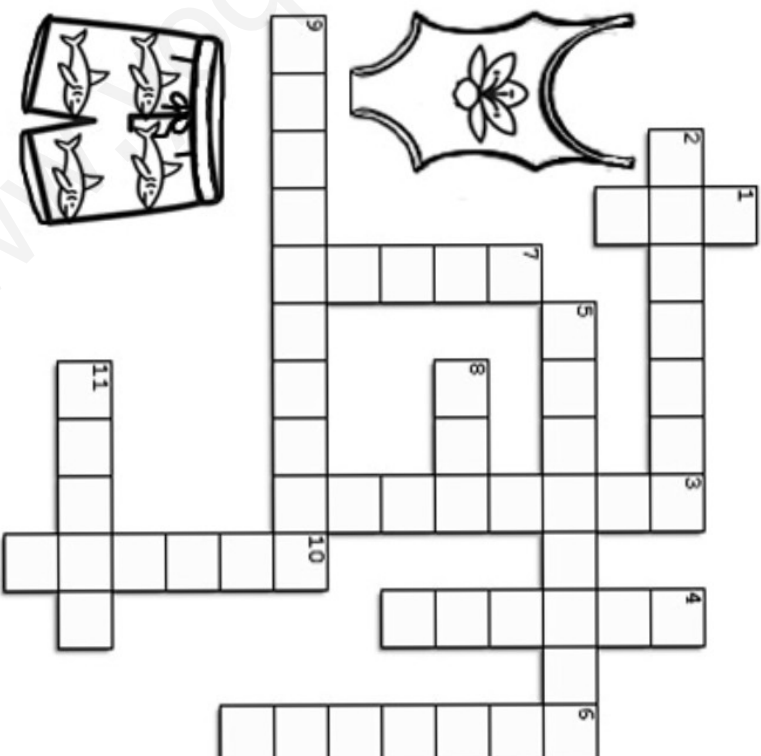

Across

- 2. SOMBRILLA
- 5. BAÑADOR(Chica)
- 8. VENTILADOR,ABANICO
- 9. GAFAS DE SOL
- 11. TOALLA

Down

- 1. GORRO
- 3. LIMONADA
- 4. BAÑADOR (Chico)
- 6. CAMISETA
- 7. CONCHA MARINA
- 10. VERANO

6



Name

Draw the missing objects.

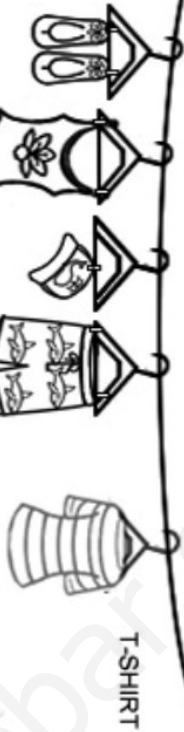

T-SHIRT



FLIPPLOPS



CAP

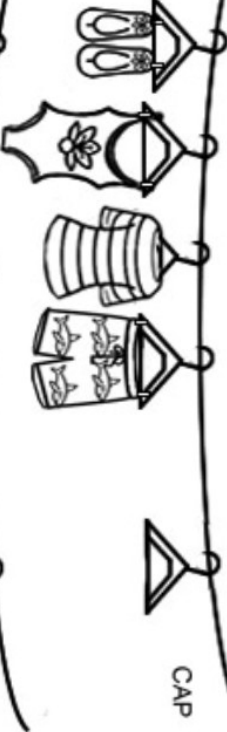

TRUNKS

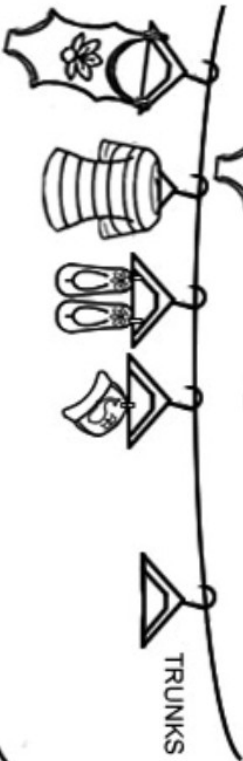

SWIMSUIT



Name

Put the letters in order to make the words.

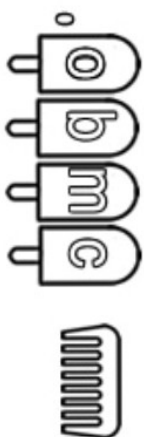

COMB

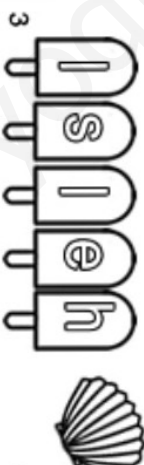
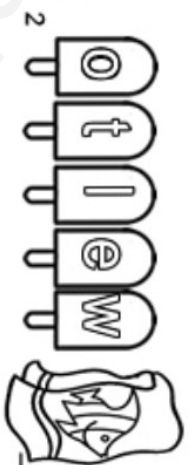

These things are for protecting your skin from the sun. Find their names in the word search.



CAP SUNGLASSES PARASOL

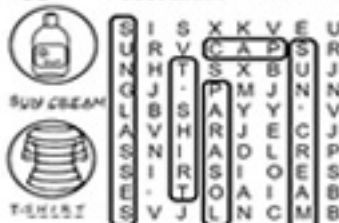

1

Choose the right word to name the picture.

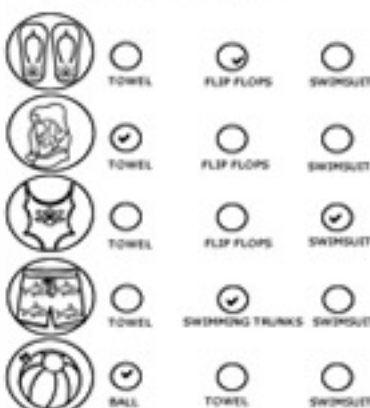

2

Complete these sentences with the right words. If it's hot,



- 1- We can open the window
- 2- We can have a shower
- 3- We can drink a lemonade
- 4- We can eat an ice-cream
- 5- We can switch on the fan

3

Complete these sentences with the possessive adjectives



- 0 Mary has got a comb. It's her comb.
- 1 The girls have got sun-cream. It's their sun-cream.
- 2 My brother has got sunglasses. They're his sunglasses.
- 3 Tom has got flip-flops. They're his flip-flops.
- 4 We have got flip-flops. They're our flip-flops.
- 5 I have got a towel. It's my towel.

4

Read and colour



5

Solve the crossword with the vocabulary of the summer in English



- Across
1. SOMBRILLA
 2. BAÑADOR/CINSE
 3. VENTILADOR/ABANICO
 4. GAFAS DE SOL
 5. TOALLA
- Down
6. CAMISETA
 7. SANDALIA
 8. CONCHA MARINA
 9. VERANO

6

Draw the missing objects.

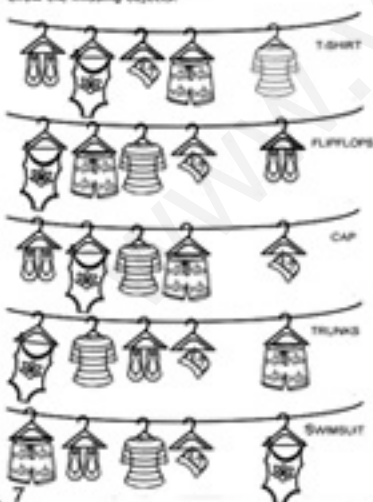

7

Put the letters in order to make the words.

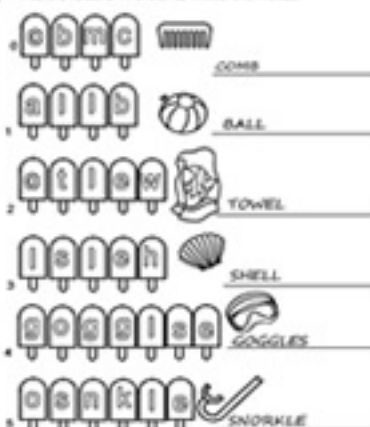

8



Soluciones



Tarjetas de referencia

<http://www.theyellowpencil.com/eleverano.html>



THE MOUNTAINS



THE COUNTRYSIDE



THE SEASIDE



FAN

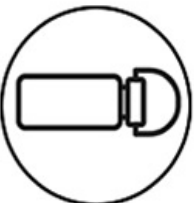

DRINK



CLOTHES



ICE-CREAM



PHOTO



SAILING

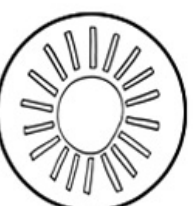

SUMMER

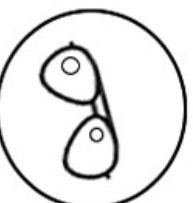

SUNGLASSES



TO SWIM



TO LIE DOWN



TO TRAVEL



TRIP

English activities

by the yellow pencil



SUMMER 2

<http://www.theyellowpencil.com/eleverano.html>

Name-----

ACTIVITY 1

English worksheet with the vocabulary of the summer.
wordsearch.

DRINK

SWIM

SAIL

LIE

TRAVEL



R D K I R V G I V R S A T M K
N B L W L C U S I X C F N
R N B I X C F N
D K L W L C U S
R V G I V R S A T M K
I V R E I S A T M K
N D S W I M H L O
K S A I L M H E L
B F T R A V W E R
K I M R K W G R



Name-----

ACTIVITY 2

Choose the right option.



sailing

swimming

trip



seaside

countryside

travel

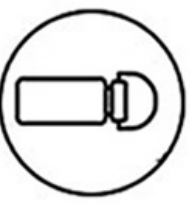

drink

ice-cream

clothes



lie down

swimming

fan



photo

fan

trip



Name-----

ACTIVITY 3

English worksheet with the vocabulary of the summer.
Scramble letters
Put the letters in order to make the words.

T R P T



M U E M R S



O L T C H E S

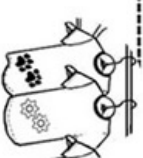

H P T O O

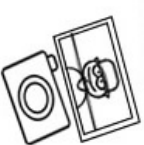

A E S D I S E

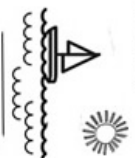

Name-----

ACTIVITY 4

English worksheet with the vocabulary of the summer.
Read and colour.

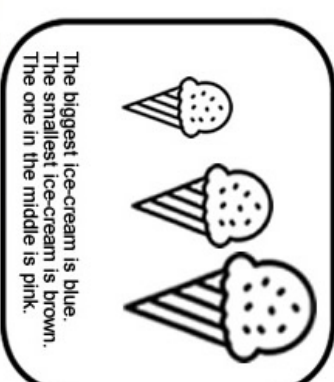
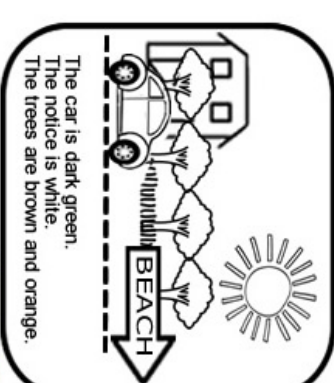
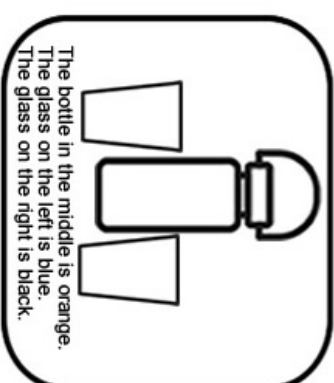
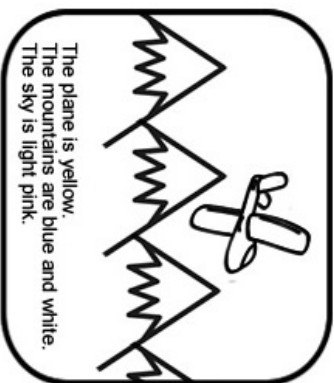

Name-----

ACTIVITY 5

English worksheet with the vocabulary of the summer.
Solve the crossword.

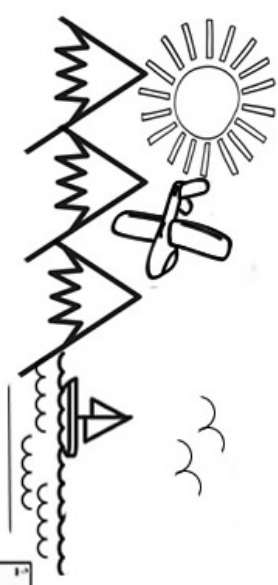

ACROSS

- 5 PLAYA
- 7 CAMPIÑA
- 8 COSTA

DOWN

- 1 MONTAÑAS
- 2 ABANICO
- 3 FOTO
- 4 VERANO
- 6 GAFAS DE SOL

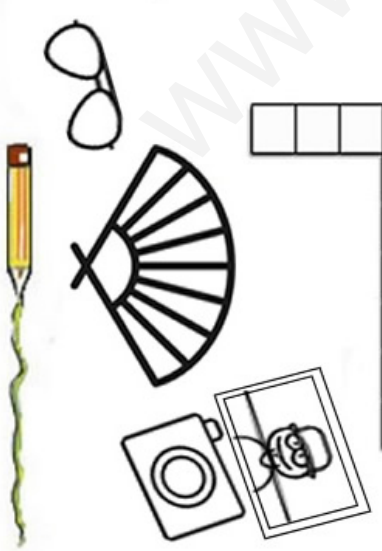

Name-----

ACTIVITY 6

English worksheet with the vocabulary of the summer.
Definitions.
Write the number of the definition on the circle.



1 Swimming



2 Ice-cream



3 Photo

A frozen food containing cream.

A picture made by a camera.

They protect your eyes from the sun.

It's for keeping you cool.

To be in a flat position on a surface.

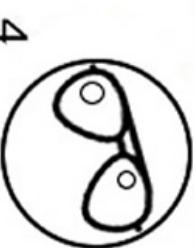

4 Sunglasses



5 To lie down



6 Fan

Name-----

ACTIVITY 7

English worksheet with the vocabulary of the summer.
Secret code.

A B C D E F G

H I J K L M N

O P Q R S T U V

W X Y Z



ACTIVITY 1
 Complete the crossword with the vocabulary of the summer.
 Choose the right option.

DRINK SWIM
 SAIL
 LIE
 TRAVEL





R N B I X C F
 D K L W L C A U S T
 R V G I I S L M H L O
 N D S A I L M H L O
 K S A I L M H L O
 B F T R A V E L
 K I M R K W G

ACTIVITY 2
 Complete the crossword with the summer.
 Choose the right option.

 strolling swimming trip
 beach Country side towel
 beach ice-cream clothes
 lie down swimming fan
 photo fan trip

ACTIVITY 3
 Complete the crossword with the vocabulary of the summer.
 Drag the letters in order to make the words.

Trip 
 T R I P

Summer 
 S U M M E R







Clothes 
 C L O T H E S

Photo 
 P H O T O

Beach 
 B E A C H

Seaside 

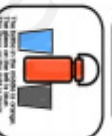
ACTIVITY 4
 Complete the crossword with the vocabulary of the summer.
 Read and colour!

  
 The man is wearing a hat and a coat.
 The tent is in the mountains.
 The tent is in the mountains.

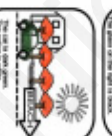
 
 The boy is eating an ice cream.
 The boy is eating an ice cream.



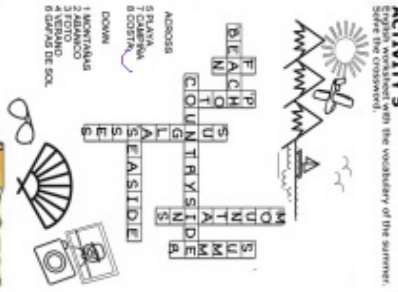



ACTIVITY 5
 Complete the crossword with the vocabulary of the summer.
 Write the answer.





ACROSS
 5 PLAY
 7 GARMENT
 8 COSTUME
 DOWN
 1 HOLIDAY
 2 HOLIDAY
 3 HOLIDAY
 4 GARMENT

BEACH
 T
 C O U N T R Y S I D E
 S U M M E R
 S E A S I D E
 S U M M E R
 S U M M E R

ACTIVITY 6
 Complete the crossword with the vocabulary of the summer.
 Definitions. Write the number of the definition on the circle.
 Write the number of the definition on the circle.

1. Summer  3. Photo 
 2. Ice-cream 
 A frozen food containing cream. _____
 A picture made by a camera. _____
 They protect your eyes from the sun. _____
 It's for keeping you cool. _____
 To be in a four position on a surface. _____
 4. Sunglasses  5. To lie down 
 6. Fan 

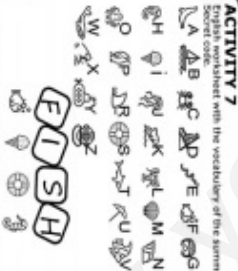
ACTIVITY 7
 Complete the crossword with the vocabulary of the summer.
 Sort the cards.

FISH 
SUMMER 
TOWEL 

<http://www.theyellowpencil.com/elverano.html>

