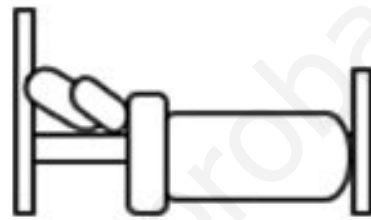

**ACTIVITY 1**

English worksheet with the bedroom.

Word search

 BLANKET  BED PILLOW SHEETS

K	C	V	R	L	G	E
S	B	V	I	L	O	G
P	I	L	L	O	W	C
C	Y	B	E	D	C	A
B	L	A	N	K	E	T
M	I	R	R	O	R	R
R	S	H	E	E	T	S



**ACTIVITY 2**

English worksheet with the bedroom.

Match



DESK

BEDSIDE  
TABLE

LAMP



CURTAIN



PILLOW



**ACTIVITY 3**

English worksheet with the bedroom.  
Mirror writing.

EBORDRAW

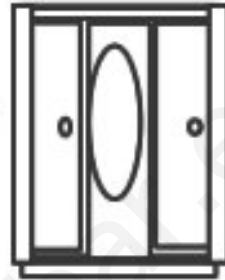

RORRIM



TAM



TEKNALB



**ACTIVITY 4**

English worksheet with the bedroom.

Missing vowels

D \_ S K



C L \_ C K



S H \_ \_ T S



B \_ D

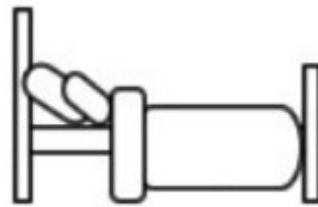

## ACTIVITY 5

English worksheets with the bedroom.  
Crossword.

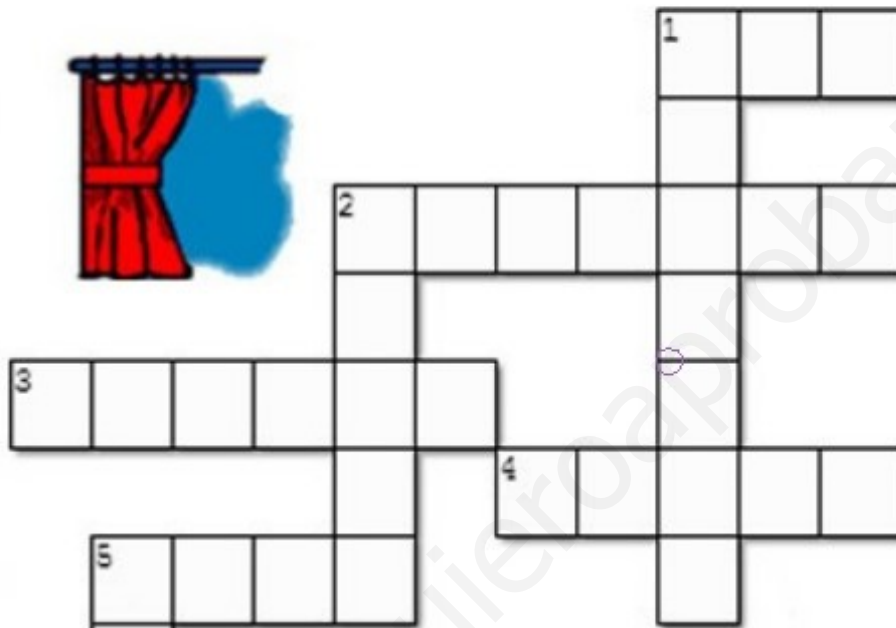

### Across

1. CAMA
2. CORTINA
3. ALMOHADA
4. SÁBANA
5. PUPITRE

### Down

1. MANTA
2. RELOJ



**ACTIVITY 6**

English worksheet with the bedroom  
TEST

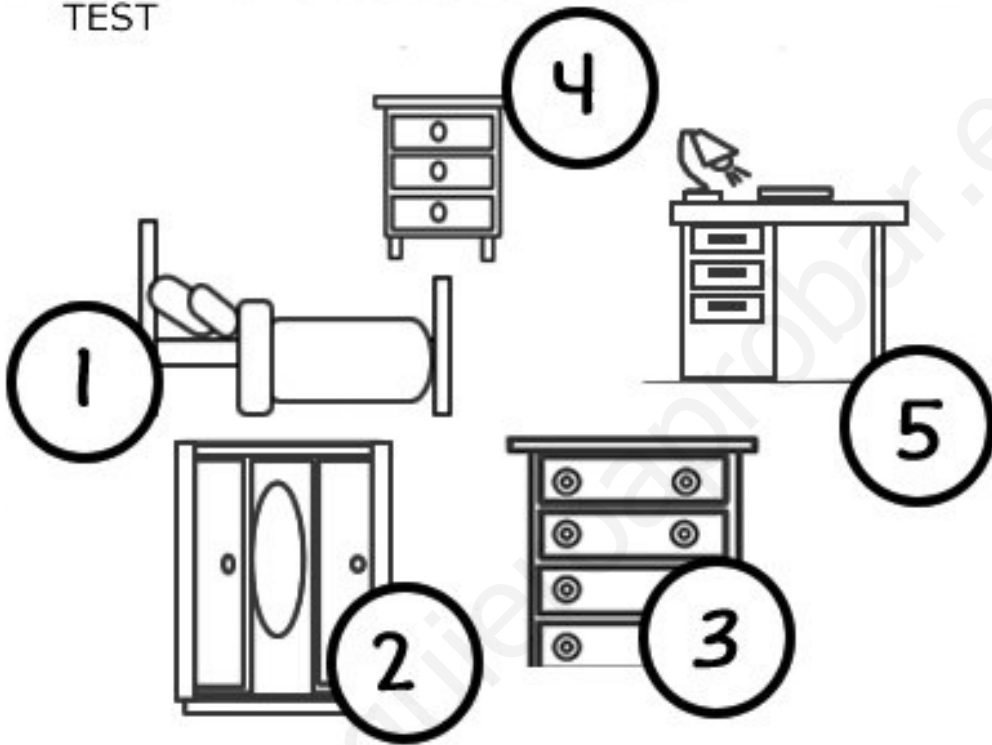

1 - - - - -

2 - - - - -

3 - - - - -

4 - - - - -

5 - - - - -



**ACTIVITY 7**

English worksheets with the bedroom

Secret code.



**ACTIVITY 1** *Solución*  
English worksheet with the bedroom.  
Word search

BLANKET  BED  
 PILLOW   
 SHEETS

K C V R L G E  
S B V I L O G  
P I L L O W C  
C Y **B E D** C A  
**B L A N K E T**  
**M I R R O R R**  
R **S H E E T S**





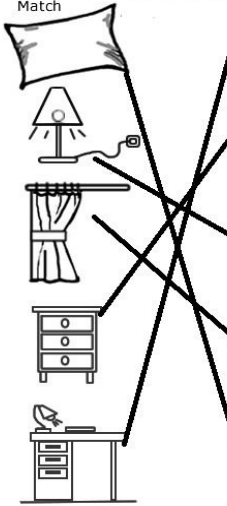

**ACTIVITY 2** *Solución*  
English worksheet with the bedroom.  
Match



DESK  
BEDSIDE TABLE  
LAMP  
CURTAIN  
PILLOW







**ACTIVITY 3** *Solución*  
English worksheet with the bedroom.  
Mirror writing.

EBORDRAW   
WARDROBE  
RORRIM   
MIRROR  
TAM   
MAT  
TEKNALB   
BLANKET

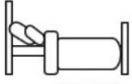

**ACTIVITY 4**  
English worksheet with the bedroom.  
Missing vowels

**DESK**   
**CLOCK**   
**SHEETS**   
**BED** 



**ACTIVITY 5**  
English worksheets with the bedroom.  
Crossword.

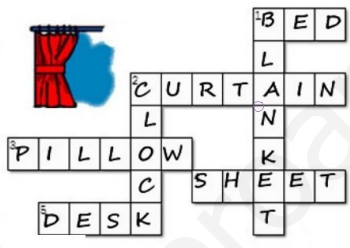

**Across**  
1. CAMA  
2. CORTINA  
3. ALMOHADA  
4. SÁBANA  
5. PUPITRE

**Down**  
1. MANTA  
2. RELOJ



**ACTIVITY 6** *Solución*  
English worksheet with the bedroom  
TEST

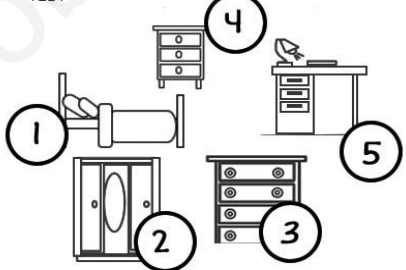

1. BED  
2. WARDROBE  
3. CHEST OF DRAWERS  
4. BEDSIDE TABLE  
5. DESK



**ACTIVITY 7**  
English worksheets with the bedroom  
Secret code.

A B C D E F  
G H I J K L  
M N O P Q R  
S T U V W X  
Y Z

**SHEET**  
**DESK**  
**PILLOW**

