



ca que qui co cu  
Ca Que Qui Co Cu

C

qu



casa

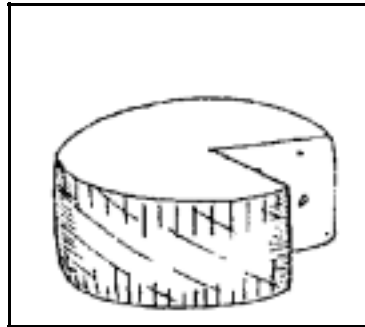

queso

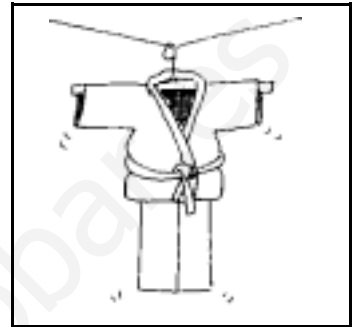

quimono

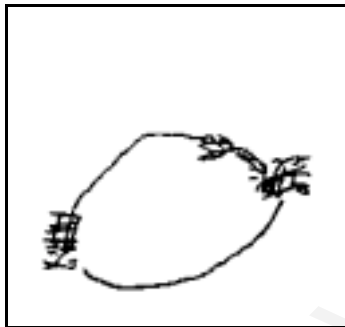

coco

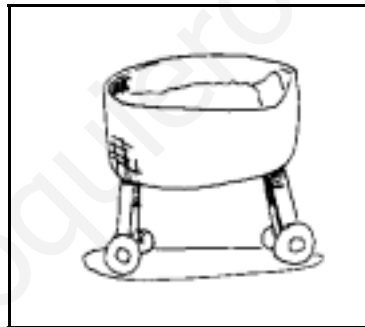

cuna

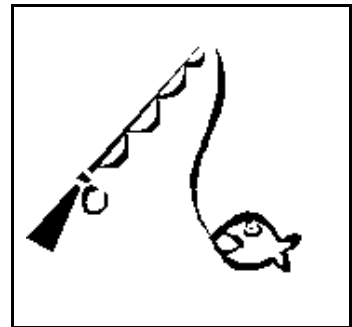

pescado

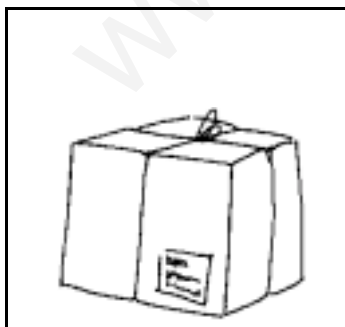

paquete



equipo

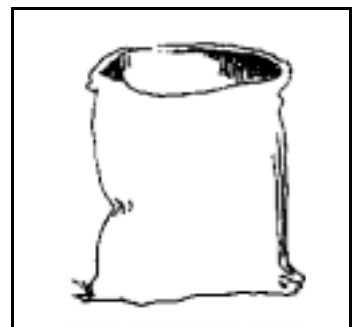

saco



ca que

ca que qui ce cu

Ca Que Qui Ce Cu

queso mosquito cometa paquete

Quique máquina equipo

esquimal cama maqueta

coqueta mequeta esquina

estanque camisa quitasol

quinqué melocotón manteca

médico medicamento

columpio comilón camino

pescado escuela cacahuetes

campana casa sace cece copa

cuce cucú

Toca el cucú de Quique



Ca Que Qui Ce Cu

ca que qui ce cu

La cometa de Quique

La cama del esquimal

La máquina del cohete

El helado de coco

Caí en la esquina de mi casa

Cuenta con el equipo de Pato

La mosca pica al esquimal

¿Qué te pasa?



¿Qué te pasa?

Me duele la mano

¿Te picó el mosquito?

No, me caí al suelo

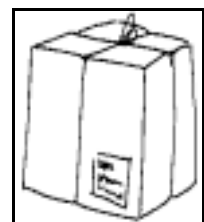
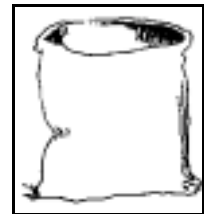
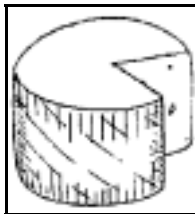
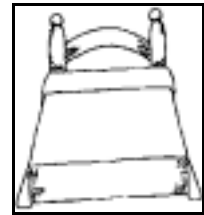
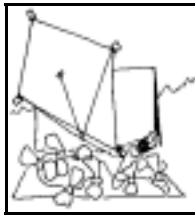

una cometa  
 una cama  
 un saco  
 un queso  
 un helado  
 una cuna  
 un coco  
 un equipo  
 un camión  
 un paquete



equipo



esquimal



casa



peccado

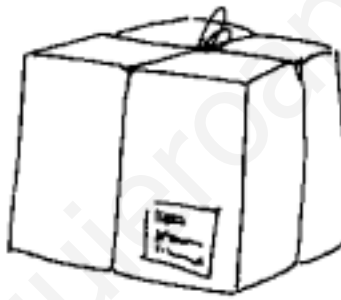

paquete

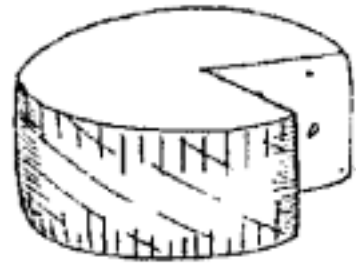

queso



químomo



campana



saco

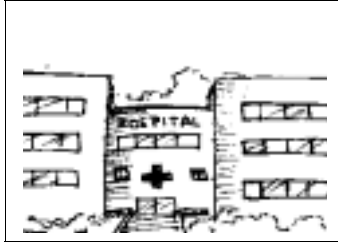

El médico sale del hospital

---

---

---



El estanque de los seis patitos

---

---

---

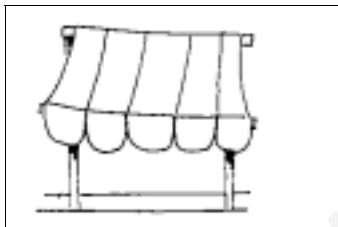

El toldo hace de quitasol

---

---

---



La casa del esquimal es de hielo

---

---

---



## un - una

un diente

una pala

\_\_\_\_\_ copa

\_\_\_\_\_ cama

\_\_\_\_\_ camisa

\_\_\_\_\_ paquete

\_\_\_\_\_ pescado

\_\_\_\_\_ comida

\_\_\_\_\_ canoa

\_\_\_\_\_ quimono

\_\_\_\_\_ cuento

\_\_\_\_\_ escuela

\_\_\_\_\_ cohete

\_\_\_\_\_ quinqué

\_\_\_\_\_ máquina

\_\_\_\_\_ cuna

~~melocotones~~ ~~estanque~~ camisas médicos  
 cacahuetes casas quesos quimonos esquina  
 cuentos esquimal cocos máquina moqueta  
 mantecas quitasol









ca-co-cu

melocotones

que-qui

estanque



 <p>Leo...</p>	<p>La casa del esquimal</p>	
		
<p>Nuy es un esquimal</p>	<p>Su casa es de hielo</p>	<p>Pasea en canoa</p>
		
<p>Come pescado</p>	<p>Seca el quimono</p>	<p>Enciende el quinqué</p>



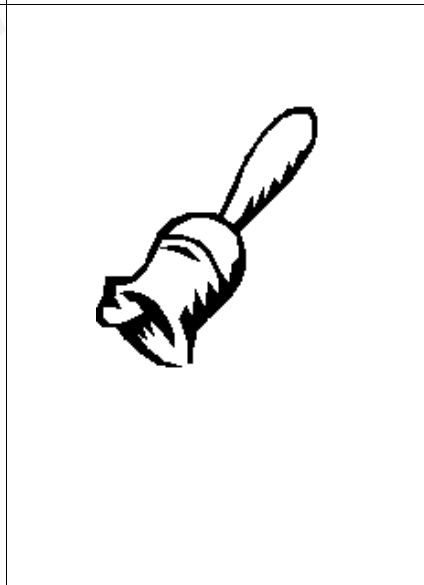
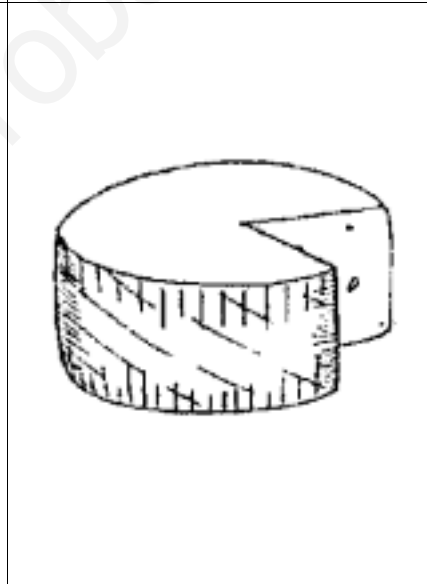
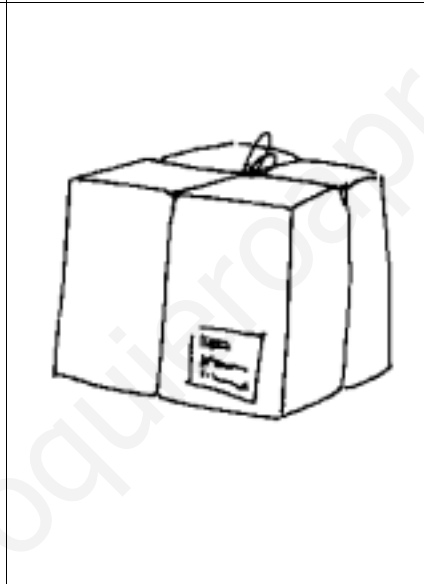
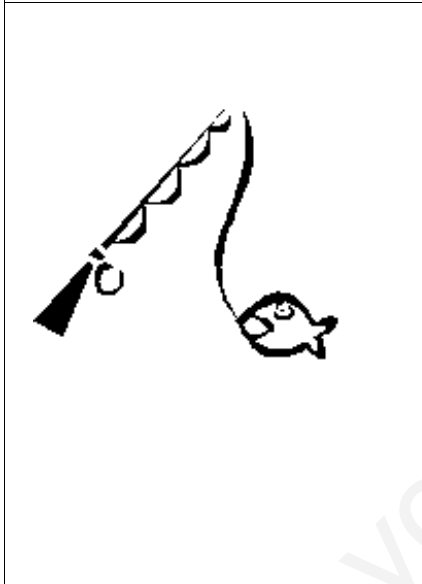



Nadia tiene una



.....  
-----  
.....

Emi sale del



.....  
-----  
.....



come pan con



.....  
-----  
.....

La  es de Hu y de Sam

.....  
-----  
.....

Ahmed cuida la



de su tío

.....  
-----  
.....



La cama del esquimal.  
El peso de mi tío Antonio.  
Como queso, pan y tomate.  
El paquete tiene una máquina.  
La casa tiene seis esquinas.  
La música sale de aquel paquete.  
Mi camisa tiene pintado un oso.  
La meta de Luis tiene siete lados.



Handwriting practice area with multiple sets of horizontal lines (solid top and bottom lines, dashed middle line) for writing practice.



Tema 13

第十三课

Unit 13

La casa del esquimal.	爱斯基摩人的家	The skimo's house
Nuy es un esquimal.	努伊是个爱斯基摩人。	Nuy is an skimo
Su casa es de hielo.	他家是用冰做的。	His house is made of ice
Pasea en canoa.	乘独木舟散步。	He rides his canoa
Come pescado.	吃鱼。	He eats fish
Seca el quimono.	把和服晒干。	He dries his kimono
Enciende el quinqué.	把煤油灯点亮。	He lights the lamp



La cama del esquimal.	爱斯基摩人的床。	The skimo's bed
El pescado de mi tío Antonio	我叔叔安东尼奥的鱼。	Mi uncle Antonio's fish
Como queso, pan y tomate.	吃奶酪、面包和番茄。	I eat some cheese, bread and tomatoe
El paquete tiene una máquina.	包裹里有个机器。	The package has a machine
La casa tiene seis esquinas.	家里有六个角落。	The house has six corners
La música sale de aquel paquete.	音乐声从那个包裹里发出。	Music is coming out from that package
Mi camisa tiene pintado un oso.	我的汗衫上画了一个熊。	My shirt has a bear painted on it
La cometa de Luis tiene siete lados.	路易斯的风筝有七条边。	Luis' kittle has six sides