

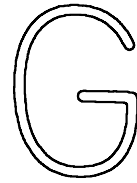

ga go gu

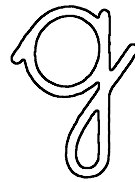

monigote

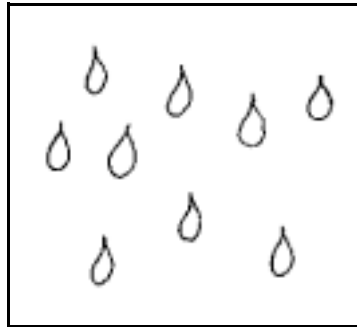

gotas



goma



gusano

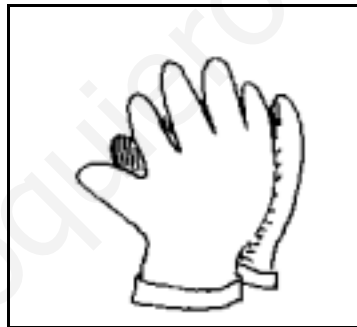

guantes

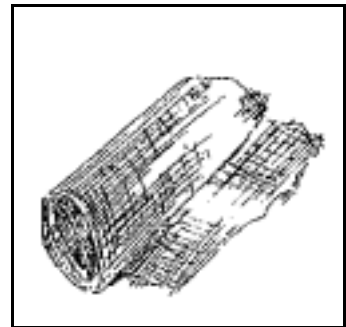

gasa



gato

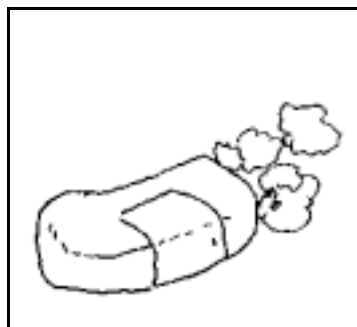

algodón

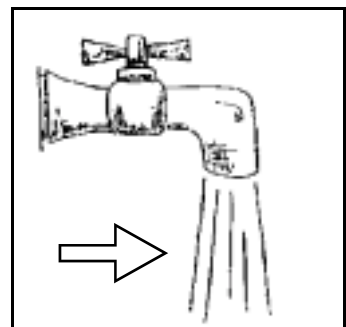

agua

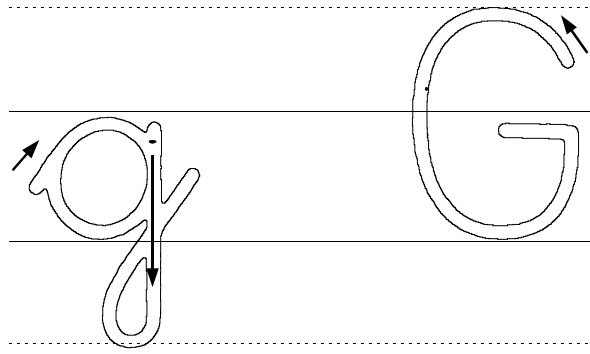

ga ge gu

Ga Ge Gu

monigote gato gusano lechuga
gota guantes algodón

Mamá usa guantes de goma.
El gato no usa guantes.
Diego seca a su gato y lo
mete en una palangana con
agua caliente.
El gato se asusta.
Salpica muchas gotas.
Luego lo seca.



Ga Ge Gu

ga ge gu

Pinto un monigote

Tengo en la mano una gasa

El gusano está en el agua

Tengo dos gemas y un papel

Limpio con algodón el dedo

Meto un gel a Diego

El gato no usa guantes

¡Qué guay!



¿Has metido un gol?

Si, y estoy muy content

¿Tomas agua?

No, tomo leche

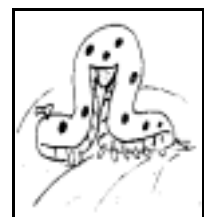
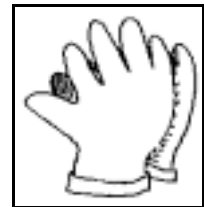
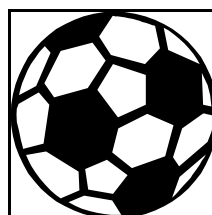
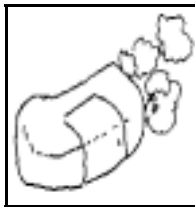
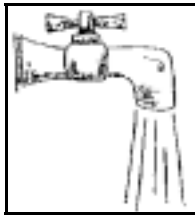

el agua
 las gotas
 los guantes
 la leche
 el algodón
 el gusano
 la gasa
 el gato
 la goma
 la pelota





mimicote

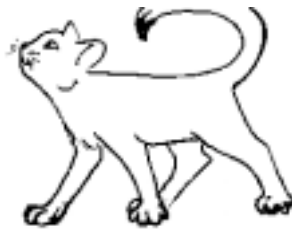

gato



gotas



quasame



guantes

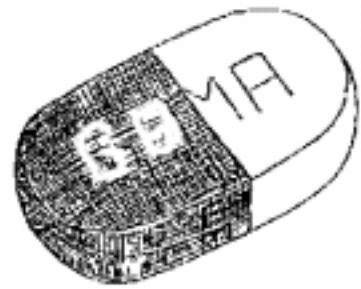

gema

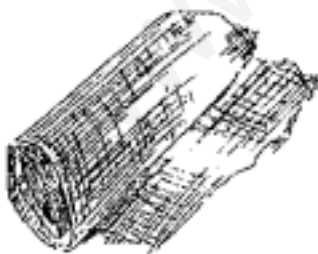

gasa



algodón

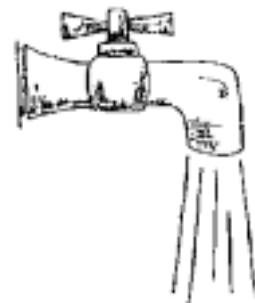

agua

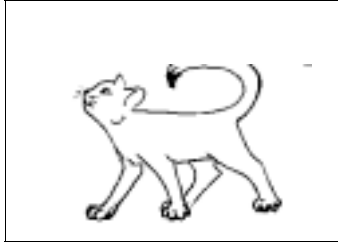

Diego asea a su gato

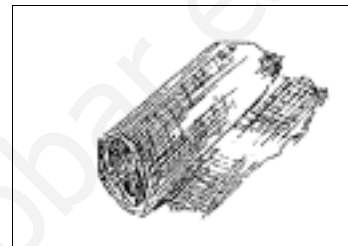

El médico le pone gasa en el dedo

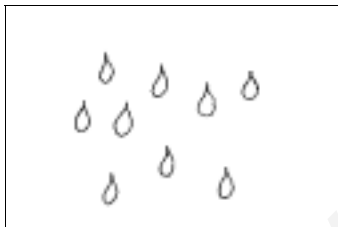

Gotas de agua caen en el coche



Diego mete un gol



el - la

el paquete
 _____ algodón
 _____ gata
 _____ monigote
 _____ guante
 _____ pomada
 _____ camión
 _____ coche

la gasa
 _____ médico
 _____ gol
 _____ gato
 _____ gota
 _____ esquimal
 _____ mancha
 _____ agua

~~esquina~~ quentes gasa esquimal
 queso algodón quimono monigote
 agua paquete

G

Q
esquina



 <p>Leo...</p>	<p>¡Gol!</p>	
		
<p>Luis ¿Tienes la pelota?</p>	<p>Sí, Lola, aquí está</p>	<p>Pásamela, Nacho</p>
		
<p>Toma, Adela</p>	<p>¡Cuidado, Quique!</p>	<p>¡Gol!</p>

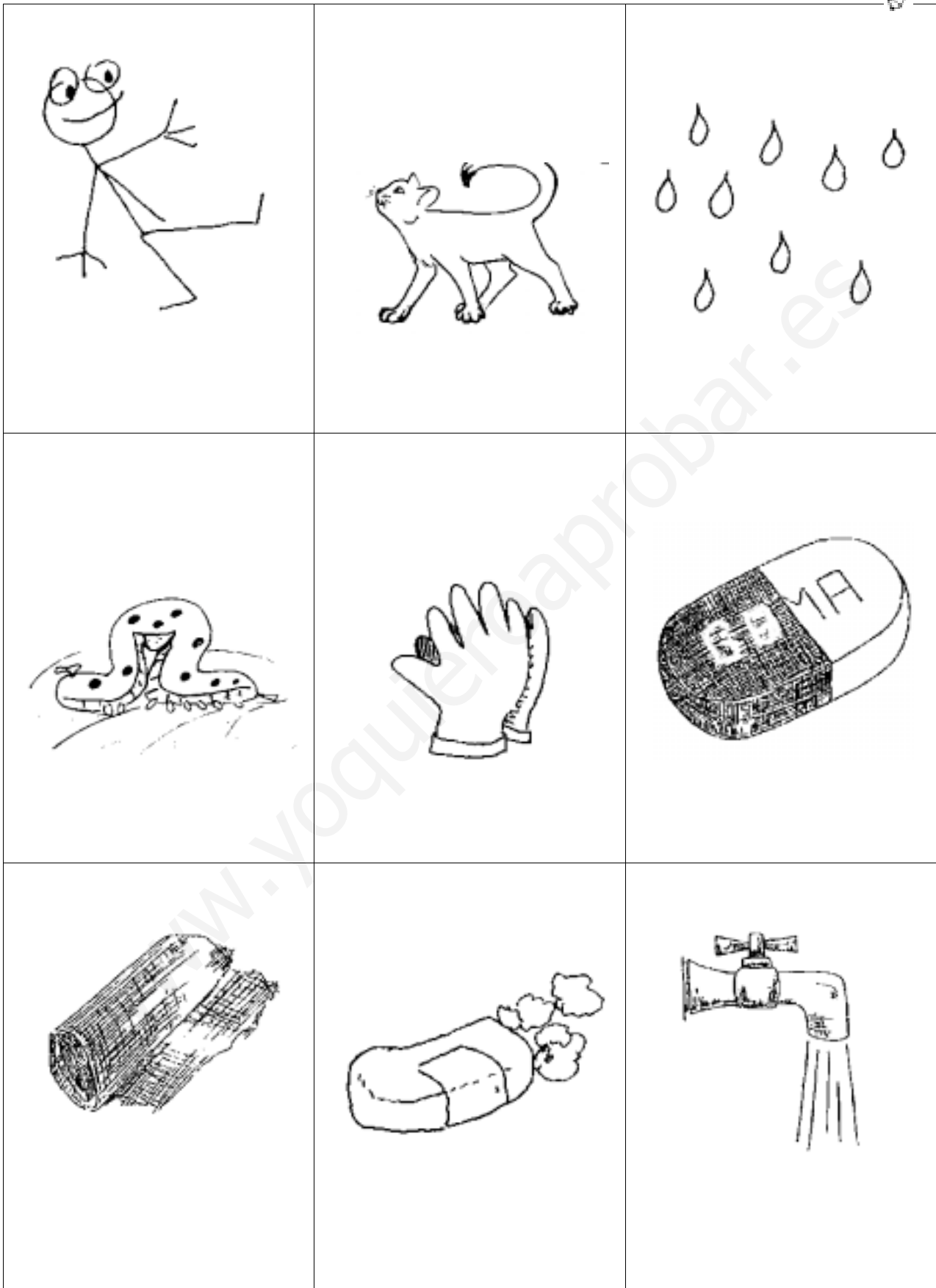



El  se asusta

.....

.....

Usa unos  de goma

.....

.....

 limpia el  con agua

.....

.....

El médico pone  en el dedo

.....

.....

Pinto un  y uso la goma

.....

.....



Diego asea al gato.
Lo mete en una palangana.
La palangana tiene agua caliente.
Usa unos guantes de goma.
El gato se asusta.
Salpica muchas gotas de agua.
Se pone al sol.
Luego se seca.



Handwriting practice area with multiple sets of horizontal lines (solid top and bottom lines, dashed middle line) for writing practice.



Tema 15	第十五课	Unit15
¡Gol!	进球！	Goal!
Luis, ¿Tienes la pelota?	路易斯，你控制球了吗？	Luis, are you holding the ball?
Sí, Lola, aquí está.	是的，劳拉，球在这里。	Yes, Lola, here it is
Pásamela. Nacho.	传给我，纳翘。	Pass it to me, Nacho!
Toma, Adela.	接着，阿黛拉。	Here you are, Adela
¡Cuidado, Quique! ¡Gol!	小心，奇盖！进球！	Look out, Quique! Goal!
		
Diego asea al gato.	迪耶哥给猫洗澡。	Diego is cleaning the cat
Lo mete en una palangana	把猫放进脸盆。	He is putting it in a washbasin
La palangana tiene agua caliente.	脸盆里的水很烫。	The washbasin is containing some hot water
Usa unos guantes de goma.	他戴着橡皮手套。	He uses rubber gloves
El gato se asusta.	猫很害怕。	The cat has got frightened
Salpica muchas gotas de agua.	把水都溅出来了。	It is spilling a lot of water
Se pone al sol.	晒太阳。	It is staying under the sun
Luego se seca.	后来就干了。	Then it dries