

Home-School Connection Pack

Quest

5



Topics

- Food
- Technology
- Sports
- Cinema
- The sea
- Jobs
- The world
- Holidays

Material on-line para Andalucía
incluyendo contenido del *Tests &
Photocopiable resources CD* y del
Activity Book de **Quest 5**.

MACMILLAN

Nota para padres/tutores: si quiere más práctica de
inglés para sus hijos, solicite el **Activity Book** de **Quest 5**
(isbn: 978-0-230-42452-4) en su librería habitual.



Quest 5

Food

Vocabulary 1

1 Look. Write the words.

Word Quest 1

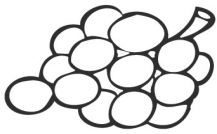

1 spager

grapes

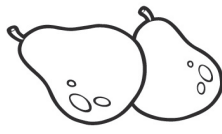

2 raspe



3 ceespha



4 isnoon



5 osomhurms



6 etsewronc

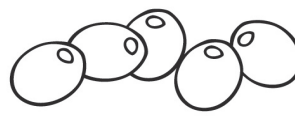

7 loveis



8 prepsep

2 Read and match.



1 I love peaches and pears!

2 I don't like peppers.

3 I hate onions!

4 I like green beans and sweetcorn.

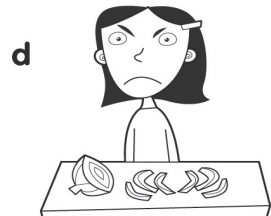

3 Look. Write the words.

Word Quest 2

put stir peel wash cut into slices

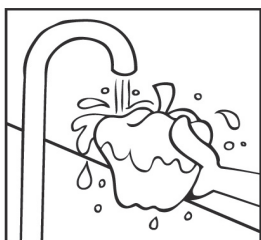

1 *wash*

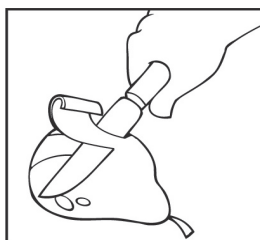

2

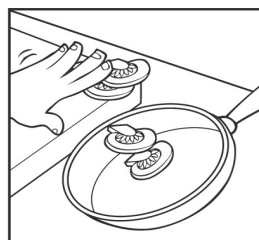

3

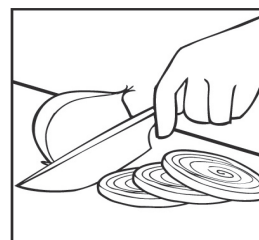

4

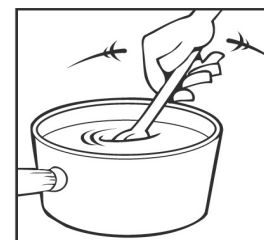

5

1 Read and complete the sentences for you.

love like don't like hate

- 1 I _____ grapes.
- 2 I _____ peppers.
- 3 I _____ mushrooms.
- 4 I _____ peaches.
- 5 I _____ green beans.



- 6 I _____ olives.
- 7 I _____ peas.
- 8 I _____ sweetcorn.
- 9 I _____ pears.
- 10 I _____ onions.

2 Remember the story. Put the sentences in order.

- It's got onions, grapes and chocolate!
- What do you like on pizza? Love, Toby
- Toby reads his messages.
- 1 Do you like pizza?
- Can I have a surprise pizza, please?
- Clare loves mushrooms, but Billy hates mushrooms.



3 Remember the story. Read and write 'True' or 'False'.

- 1 The children are in New York.
- 2 Nicola likes pizza with lots of cheese.
- 3 Clare loves mushrooms and peppers.
- 4 Billy doesn't like olives.
- 5 The children eat a surprise pizza.
- 6 The pizza has got onions, grapes and chocolate.

False

1 Read and complete the Grammar Quest.

Grammar Quest

Present simple – likes/dislikes

doesn't loves likes does hates like Does like

Affirmative

♥ He **1** loves peppers.

😊 She **2** _____ grapes.

Negative

☹ He doesn't **3** _____ mushrooms.

☹☹ She **4** _____ peaches.

Questions and short answers

5 _____ he likes pears?

No, he **6** _____.

7 Does she _____ onions?

Yes, she **8** _____.

2 Read and circle the correct word.

1 I love / loves grapes.

4 Does / Do she like peppers?

2 He like / likes sweetcorn.

5 I hates / hate green beans.

3 She doesn't / don't like peaches.

6 He loves / love olives.

3 Look and complete the sentences.



1 He loves tomatoes.

5 He _____ pears.

2 She hates grapes.

6 She _____ peaches.

3 He _____ peas.

7 _____ green beans.

4 She _____ olives.

8 _____ sweetcorn.

Quest 5

Food

CLIL Natural Science

13 Read and circle the words. Complete the sentences.

cactusirleavesso vine pasnwaterwusunytoevergreenmebcg

- 1 A vine is a plant that climbs up something, to get more energy from the _____.
- 2 A _____ is a plant that doesn't need lots of _____.
- 3 An _____ tree is a tree which has got _____ all year.

14  Tick the chart. Listen and check.

	grow on an evergreen tree	grow on a plant similar to a cactus	grow on a vine	have got a lot of vitamin C	have got a lot of vitamin E
tomatoes			✓		
pineapples					
olives					

15 Look at Activity 14 and complete the sentences.

- 1 Tomatoes grow on a vine and have got a lot of _____.
- 2 Pineapples _____.
- 3 Olives _____.

16  Listen and circle the correct answers.

- 1 Kiera likes ... a) pears b) tomatoes c) olives
- 2 She likes them because ... a) they're red b) they're a fruit c) they've got lots of vitamin C
- 3 Kiera doesn't like ... a) grapes b) onions c) green beans
- 4 She doesn't like them because ...
a) they're green b) they've got lots of seeds c) they've got a strong smell

I like ... What about you?



17 Complete the amazing facts. Write the mystery word.

Amazing facts

olive years cone

Mystery Word!

□ n □ □ □ □

- 1 The name pineapple comes from the word pine _ □ _ □ _.
- 2 An □ _ □ _ tree can live for over 1000 _ □ _.

Quest 5

Technology

Vocabulary 1

1 Read and match.

Word Quest 1

1 computer

2 MP3 player

3 computer games

4 email



5 photo

6 web page

7 webcam

8 text message

2 Read and complete the phrases.

surf log in to write use read listen to play take log out of send

1 log in to a computer

6 _____ computer games

2 _____ an MP3 player

7 _____ the internet

3 _____ text messages

8 _____ a web page

4 _____ photos

9 _____ emails

5 _____ a webcam

10 _____ a computer

3 Write the words to complete the sentences.

Word Quest 2

1 **f o t n e** I often surf the internet.

2 **v e r n e** I _____ use a webcam.

3 **m o s t i s e m e** I _____ write emails.

4 **w a l s a y** I _____ listen to my MP3 player.



Quest 5

Technology

Vocabulary 2

1 Read and circle the correct word.

- 1 Julie **surf** / **surfs** the internet.
- 2 I **send** / **sends** text messages to my friends.
- 3 David **listen to** / **listens to** music on his MP3 player.
- 4 **Do** / **Does** he take photos on his mobile phone?
- 5 She **don't** / **doesn't** play computer games.
- 6 **Do** / **Does** you use a webcam?



Grammar Quest

2 Remember the story. Complete and put the sentences in order.

write emails teacher Science log in to receptionist 700

- She talks to people, but she doesn't _____.
- Finally, Saya works in a primary school as a substitute _____.
- 1 Professor Hiroshi Kobayashi works at the Tokyo University of Science.
- First, Saya works at the university. She is a _____.
- She can say about _____ words.
- Please _____ a computer.

SAYA
THE ROBOT



3 Remember the story. Read and write 'True' or 'False'.

- 1 The professor works at Tokyo University of Science. True
- 2 Pikarin hasn't got a metal head. _____
- 3 Saya can speak six languages. _____
- 4 Saya understands everything. _____
- 5 Saya works in a hospital. _____
- 6 Lots of children like Saya. _____

1 Read and complete the Grammar Quest.

Grammar Quest

Present simple – he/she

listens to doesn't does play Does read sends doesn't

Affirmative

- 1 He listens to an MP3 player.
- 2 She _____ text messages.

Negative

- 3 He doesn't _____ computer games.
- 4 She _____ write emails.

Questions and short answers

- 5 Does he _____ a web page?
- 6 Yes, he _____.
- 7 _____ she surf the internet?
- 8 No, she _____.

2 Read and circle the correct word.

- 1 I write / writes emails.
- 2 He play / plays computer games.
- 3 She doesn't / don't take photos.
- 4 I don't / doesn't surf the internet.
- 5 He uses / use a webcam.
- 6 Does / Do she send text messages?

3 Look and complete the sentences.

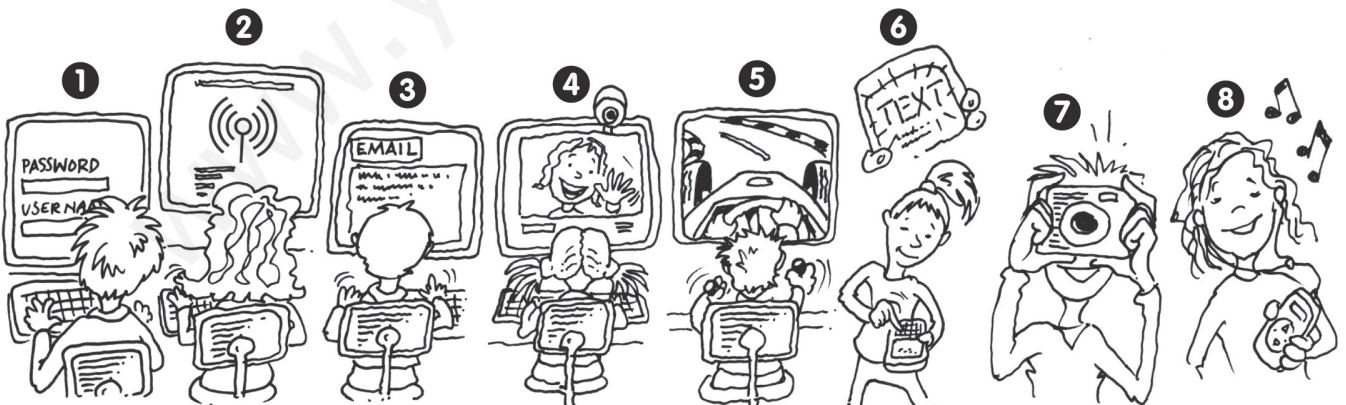

- 1 He logs in to a computer.
- 2 She _____ the internet.
- 3 He _____ emails.
- 4 She _____ a webcam.
- 5 He _____.
- 6 She _____.
- 7 _____.
- 8 _____.

13 Read and correct the sentences.

- 1 A Micro Flying Robot is a robot pet. It is similar to a person.

A Micro Flying Robot is a small robot. It is _____



- 2 An AIBO is a humanoid robot. It is similar to a helicopter.



- 3 An ASIMO is a small robot. It is similar to a dog.

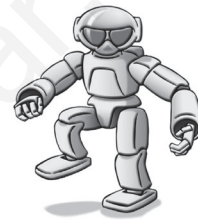

14 Write what the robots can do.

dance play with a ball fly take photos (x2) turn on lights

ASIMO



AIBO

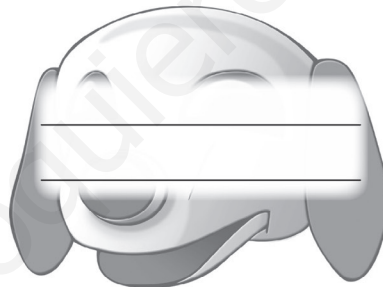

MFR

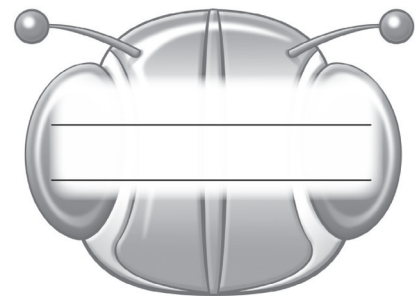

15 Look at Activity 14 and write sentences.

The ASIMO can dance and _____.

The AIBO _____.

The micro flying robot _____.

16 Complete the amazing facts. Write the mystery word.

Amazing facts

play love friend

- 1 AIBO can mean '___ ___ ___' or '___ i ___ ___' in Japanese.

- 2 'RoboSoccer' is a sport where robots ___ ___ football.

Mystery Word!

□ m □ □ □



Quest 5

Sports

Vocabulary 1

Word Quest 1

1 Complete the words. Look and match.

a  **1** j_e_t_s_k_i_i_n_g  d

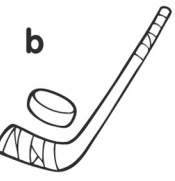
b  **2** s__o_r__e__l_i__g

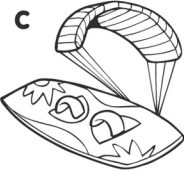
c  **3** p_l__y__n_g__c__h_o__e_y



4 __a_i__i_n__  e

5 s_n__w__o_a__d_i__g

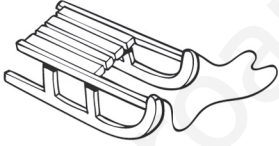

6 __i_t__s__r_f__g  f

2 Look. Write the words.

playing volleyball jet skiing sledging ice skating snorkelling skiing

1  **2**  **3** 

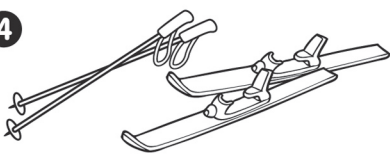
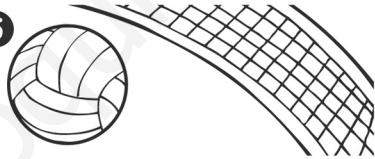
snorkelling

4  **5**  **6** 

3 Look and complete the sentences.

swimming trunks sunglasses hooded jacket flip-flops swimsuit long sleeved top



I'm wearing a **1** *swimsuit*,
2 a _____ and
3 _____ on my feet.

I'm wearing a **4** _____,
 _____,
5 _____ and
6 _____ on my eyes.

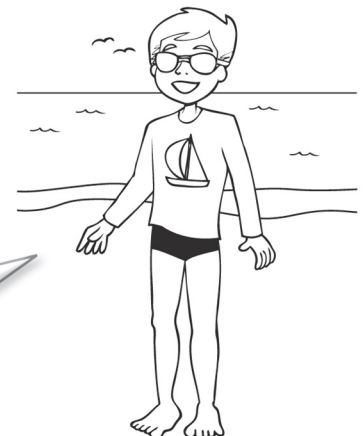

1 Look. Write the sentences.

Grammar Quest



- 1 He's snowboarding.
- 2 He isn't ice skating.
- 3 _____.
- 4 _____.

- 5 _____.
- 6 _____.
- 7 _____.
- 8 _____.

2 Remember the story. Read and complete the sentences.

safe sea sailing wave boat writing storms



- 1 This is Abby on her boat.
- 2 She's _____ around South America.
- 3 There are lots of _____.
- 4 Oh no! A big _____!
- 5 She isn't _____ her blog.
- 6 Abby is _____ at last. But her boat is still in the _____!

3 Remember the story. Read and circle the correct word.

- 1 Abby's dream is to sail / swim around the world.
- 2 After two months, she's sailing around **Australia** / **South America**.
- 3 She's half way around the world when there's a big **wave** / **boat**.
- 4 Abby's family is worried because she isn't **talking** / **writing** on the phone.
- 5 Abby sends a distress **letter** / **signal**.
- 6 She has no communication with anyone for about 20 **hours** / **days**.

1 Read and complete the Grammar Quest.

Grammar Quest

Present continuous – he/she

Is 's playing isn't playing she is isn't

Affirmative

- 1 He's playing volleyball.
- 2 She _____ kite surfing.

Negative

- 3 He _____ ice skating.
- 4 She isn't _____ ice hockey.

Questions and short answers

- 5 _____ he skiing?
- 6 Yes, he _____.
- 7 Is _____ sailing?
- 8 No, she _____.

2 Read and circle the correct word.

- 1 I **m** / 's playing ice hockey.
- 2 He 's / 'm playing volleyball.
- 3 She **isn't** / 'm not ice skating.
- 4 I 'm not / **isn't** kite surfing.
- 5 **Are** / Is you sledging?
- 6 **Are** / Is she skiing?

3 Look and complete.



- 1 _____ He's _____ sailing.
- 2 _____ skiing.
- 3 _____ playing volleyball.
- 4 _____ snowboarding.
- 5 _____ jet skiing.
- 6 _____ sledging.
- 7 _____ ice skating.
- 8 _____ snorkelling.

13 Circle. Write the words.

hat br boots vefigs sunglassesesacsuncreamyowaterpil

- 1 A hat keeps your body cool.
- 2 _____ keeps your head warm.
- 3 _____ protects your face and body from the sun.
- 4 _____ keep your feet warm.
- 5 _____ protect your eyes from the sun.



14 Complete the sentences.

accident head warm eyes snow gloves helmet goggles sun jacket

- 1 Gloves keep your hands _____.
- 2 A _____ protects your head if you have an _____.
- 3 Sunglasses protect your _____ from the _____.
- 4 A waterproof _____ is good in the _____.
- 5 _____ are good for fast sports. They protect your eyes.
- 6 A hat keeps your _____ warm.



15 Listen and circle the correct answers.

- 1 Sophie is wearing ... a) sunglasses b) a hat c) a jacket
because ... a) they're red b) it's sunny c) it's cold and sunny
- 2 Sophie isn't wearing ... a) sun cream b) a swimsuit c) a jacket
because ... a) it's hot and sunny b) it's cold and windy c) it's blue

I'm wearing ...
What about you?



16 Complete the amazing facts. Write the mystery word.

Amazing facts

volcano pads helmets

- 1 Some have got audio inside them!
- 2 The man in the photo is -boarding.

Mystery Word!

b



Quest 5

Cinema

1 Circle and write the words.



S	E	R	I	O	U	S	A	K
H	P	T	S	Y	K	I	T	O
Y	L	Z	P	X	J	N	T	N
F	I	H	O	M	V	A	R	H
Y	T	R	O	S	U	S	A	B
A	T	S	R	L	E	T	C	V
K	I	N	D	O	J	Y	T	M
S	T	F	N	A	K	Q	I	C
I	Z	H	C	U	D	L	V	R
P	O	Y	D	T	R	E	E	A

Vocabulary 1

Word Quest 1



2 Look. Write the words.

rich nasty funny confident ugly serious



3 Look. Read and match.

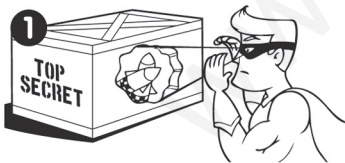

1 see through

2 climb

3 fly

4 see in

5 lift

a walls

b heavy objects

c the dark

d objects

e in the sky



Word Quest 2

1 Match the opposites. Read and complete the sentences.

Grammar Quest

confident	serious
rich	ugly
funny	poor
attractive	shy

- 1 An adult is (rich) richer than a child.
- 2 A student is (poor) _____ than a teacher.
- 3 A clown is (funny) _____ than a taxi driver.
- 4 A taxi driver is (serious) _____ than a clown.
- 5 A princess is (attractive) _____ than a frog.
- 6 A frog is (ugly) _____ than a princess.

2 Remember the story. Read and match.

THE PRINCESS AND THE TEA MAN

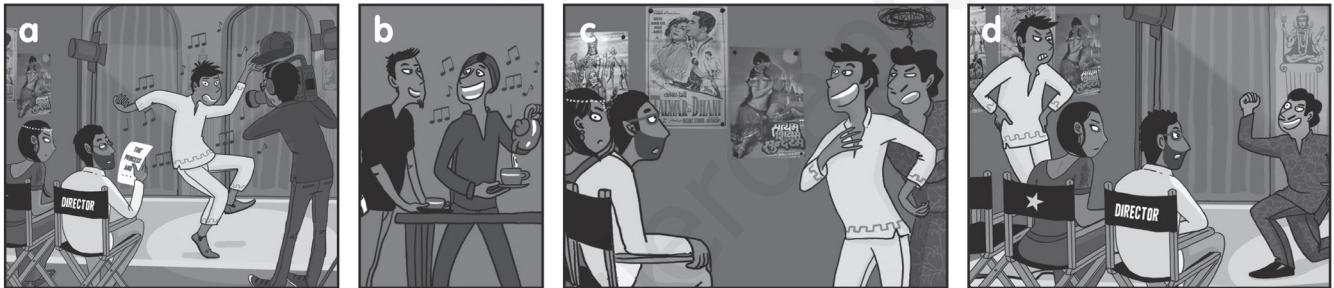

- 1 Choose me! I'm more attractive than Mr Patel.
- 2 Oh no. He's a very bad dancer!
- 3 Wow! You're a very good singer.
- 4 No, choose me! I'm stronger than Mr Raman.

3 Remember the story. Read and write 'True' or 'False'.

- 1 Mr Raman is a very good dancer. False
- 2 Mr Patel can't sing. _____
- 3 Mr Raman is more attractive than Mr Patel. _____
- 4 Mr Raman is stronger than Mr Patel. _____
- 5 The tea man is richer than Mr Raman and Mr Patel. _____
- 6 The tea man can sing and dance. _____

1 Read and complete the Grammar Quest.

Grammar Quest

To be + comparative adjectives

1 I 'm (rich) richer
than you.

2 He _____ (shy) _____
than John.

3 She _____ (poor)
_____ than him.

4 You _____ (funny)
_____ than Alice.

5 She _____ (nasty)
_____ than him.

6 I _____ (ugly) _____
than you.

7 They _____ (serious)
_____ than you.

8 I _____ (confident)
_____ than her.

9 He _____ (attractive)
_____ than Tom.

2 Read and circle the correct word.

1 I'm **more kind** / **kinder** than you.

4 I'm **more funny** / **funnier** than him.

2 He's **uglier** / **more ugly** than you.

5 He's **more poor** / **poorer** than her.

3 She's **more attractive** / **attractiver** than me.

6 She's **more serious** / **seriouser** than you.

3 Write the words in order.

1 serious / me / is / My / than / teacher / more

My teacher is more serious than me.

2 is / friend / me / funnier / than / My

3 are / My / me / mum and dad / than / richer

4 is / me / attractive / sister / than / My / more

5 brother / than / My / me / shyer / is

6 more / my / confident / than / I'm / friend

13 Write the words in the correct column.

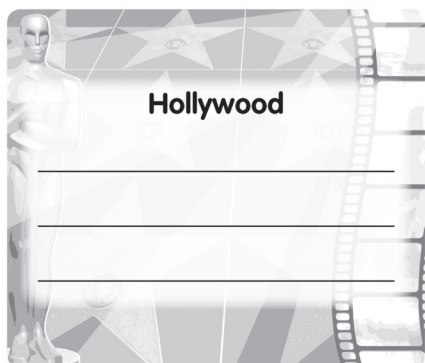

India
lots of singing and dancing
the USA
richer
lots of special effects
bigger

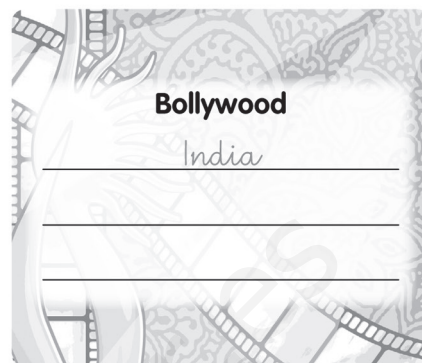

14 Write 'True' or 'False'. Correct the false sentences.

- 1 Bollywood is in the USA. False
- 2 Bollywood is smaller than Hollywood. _____
- 3 Bollywood films are often musicals. _____
- 4 Bollywood films have got lots of special effects. _____
- 5 Bollywood films have lots of dancing. _____

1 Bollywood is in India.

15  Listen and circle the correct answers.

- 1 Dan likes ... a) musicals b) funny films c) romantic films
because ... a) they're funny b) they're sad c) they're serious
- 2 Dan's favourite superhero is ... a) Batman b) Superman c) Animal Girl
because he/she ... a) can see in the dark b) can climb walls c) can fly in the sky

I like ... What about you?



16 Complete the amazing facts. Find the mystery word.

Amazing facts

Hollywood cinema Bollywood

- 1 The name 'Bollywood' comes from two words: Bombay and _____.
- 2 _____ makes more films than Hollywood.
- 3 In India, about 14 million people go to the _____ every day.

Mystery Word!

r

Quest 5

The sea

Vocabulary 1

1 Look and circle the correct word.

Word Quest 1

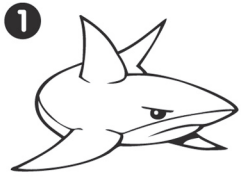

1
a shark
a whale

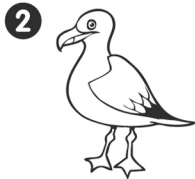

2
a penguin
a seagull

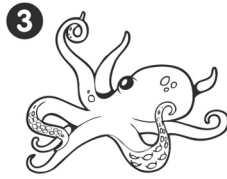

3
an octopus
a pelican

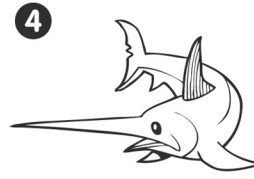

4
a jellyfish
a swordfish



5
a turtle
a sea horse

2 Look. Write the words.

1 Shark

2 Jellyfish

3 Pelican

4 Penguin

5 Turtle

6 Seagull

7 Octopus

8 Shark

3 Look and match.

Word Quest 2

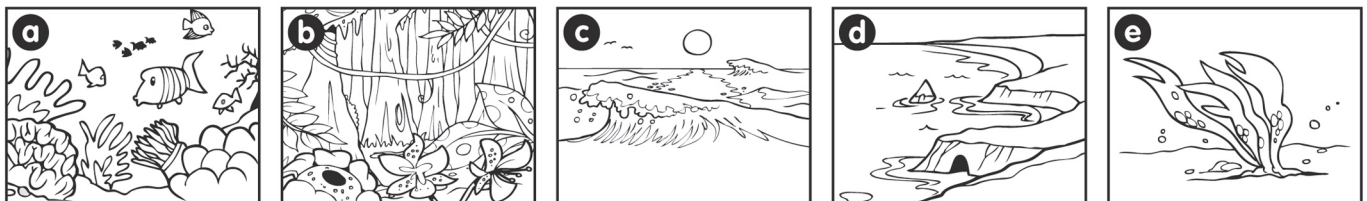

1 an ocean

2 a coral reef

3 seaweed

4 the coast

5 a rainforest

Quest 5

The sea

Vocabulary 2

1 Write the words in order.

Grammar Quest



1 are / jellyfish / There / some

There are some jellyfish.

2 There / some / are / sharks

_____.

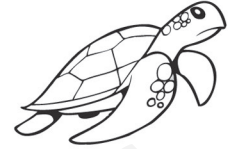

3 any / swordfish / there / Are

_____?

4 turtles / aren't / There / any

_____.

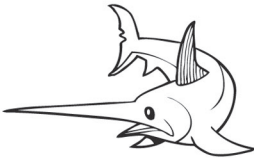

5 Are / any / penguins / there

_____?

2 Remember the story. Read and circle the correct word.

- 1 Chris, Freddie and Tanya are in Australia / South Africa.
- 2 The children go sailing / snorkelling.
- 3 There are some dolphins / sharks.
- 4 They visit an island / a rainforest.
- 5 There's a swimsuit / plastic bag wrapped around the turtle's body.
- 6 The children clean up the animals / rubbish on the beach.



3 Remember the story. Read and complete the sentences.

boat jellyfish snorkelling clean sharks save rubbish

- 1 Look! The boat 's here.
- 2 Great! Time for _____.
- 3 Be careful. Don't touch the _____!
- 4 Yes, but are there any _____?
- 5 Look at all the _____!
- 6 Let's _____ other animals. Let's _____ up this rubbish!



1 Read and complete the Grammar Quest.

Grammar Quest

There is / There are

's are isn't are aren't Is Are isn't

Affirmative

- 1 There _____ a whale.
- 2 There _____ some sharks.

Negative

- 3 There _____ a pelican.
- 4 There _____ any turtles.

Questions and short answers

- 5 _____ there a dolphin?
- 6 No, there _____.
- 7 _____ there any seagulls?
- 8 Yes, there _____.

2 Read and circle the correct word.

- 1 There **'s** / **are** a penguin.
- 2 There **'s** / **are** some sharks.
- 3 **Are** / **Is** there any sea horses?
- 4 **Is** / **Are** there a jellyfish?
- 5 There **aren't** / **isn't** any turtles.
- 6 There's **some** / **an** octopus.
- 7 Are there **some** / **any** seagulls?
- 8 There are **a** / **some** whales.

3 Look and complete the sentences.

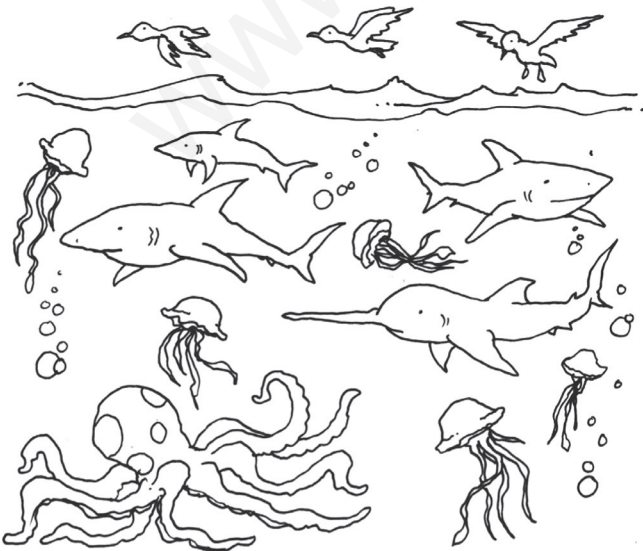

- 1 There are some sharks.
- 2 There aren't any penguins.
- 3 There _____ seagulls.
- 4 There _____ swordfish.
- 5 There _____ whales.
- 6 There _____ jellyfish.
- 7 There _____ octopus.
- 8 There _____ sea horses.

Quest 5

The sea

CLIL Natural Science

13 Write the words and the letters.

gills hard scales lots of teeth

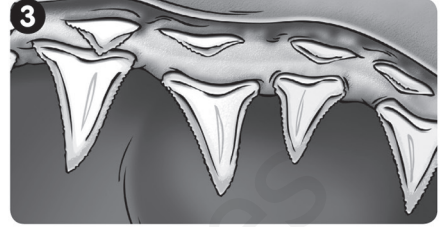
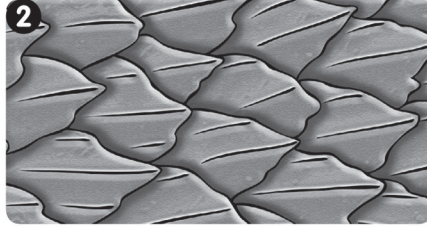
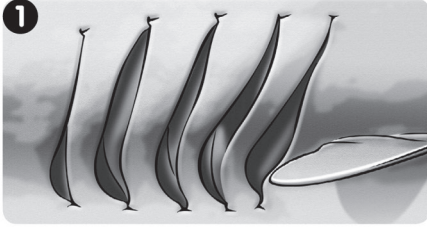

- a** These protect sharks. **b** Sharks have got these to breathe. **c** These help sharks eat meat.

14 Complete the sentences.

- Sharks are fish.
- Sharks are _____ than dinosaurs.
- There are sharks in every _____.
- There are about _____ different types of shark.
- A baby shark is called a _____.
- A pup doesn't _____ with its parents.

350

older

live

pup

fish

ocean

15 Listen and circle the correct answers.

- In the UK there are about ... a) 5 b) 100 c) **20** types of shark
- You can find ... a) cat sharks b) dog sharks c) elephant sharks
- They are ... a) big b) small c) colourful
- Sharks in the UK are normally ...
a) not dangerous b) dangerous c) very dangerous



I don't like sharks.
What about you?



16 Complete the amazing facts. Write the mystery word.

Amazing facts

attacks swim bee stings

- Sharks can only forwards.
- More people die from _____ than shark _____.

Mystery Word!

e d

Quest 5

Jobs

Vocabulary 1

1 Look and match.

Word Quest 1

- 1 a writer **h** 2 a businessperson 3 a housewife 4 a teacher 5 a waitress

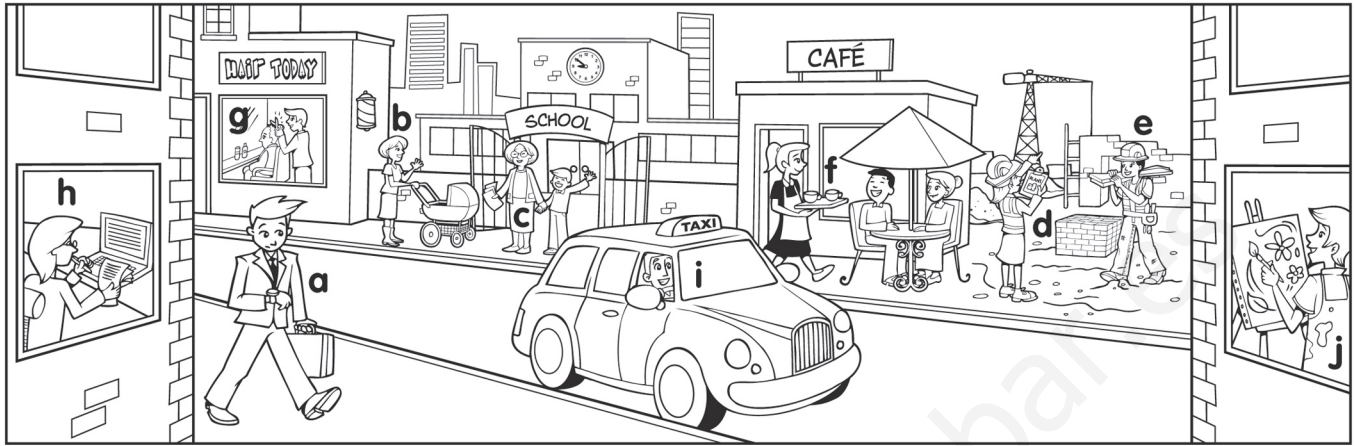

- 6 a hairdresser 7 an architect 8 a taxi driver 9 a builder 10 an artist

2 Look and complete the sentences.



She's a hairdresser.



He's _____.



She's _____.



He's _____.



She's _____.



He's _____.



She's _____.

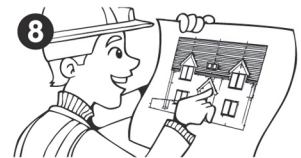

He's _____.

3 Read and match.

Word Quest 2

1 We're at a football match.

2 We're at a birthday party.

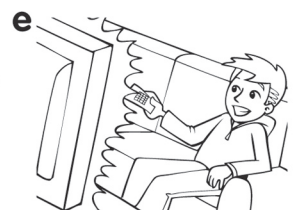
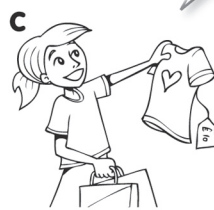

3 I'm at the shops.

4 I'm at home.

5 I'm at a family lunch.

1 Look, read and circle the correct word.

Grammar Quest

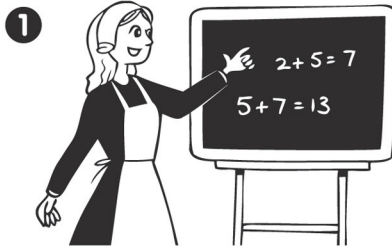

She **was** / **wasn't** an architect.



He **was** / **wasn't** a writer.



She **was** / **wasn't** a housewife.



He **was** / **wasn't** a taxi driver.



She **was** / **wasn't** a waitress.



He **was** / **wasn't** a teacher.

2 Remember the story. Put the sentences in order.



- a After an illness as a baby, Helen was deaf and blind.
- b The name of her first book was 'The Story of My Life'.
- c Helen Keller was born in 1880 in Alabama, in the USA.
- d Anne Sullivan was Helen's special teacher.
- e Helen was the first deaf and blind person to get a degree.
- f Anne was always there to help her learn.

1

3 Remember the story. Read and complete the sentences using **was** or **wasn't**.

- 1 Helen Keller was deaf and blind.
- 2 She _____ a happy child.
- 3 Anne Sullivan _____ her special teacher.
- 4 Helen _____ an intelligent girl.
- 5 She _____ a businessperson.
- 6 Her first book _____ called 'My Special Teacher'.



1 Read and complete the Grammar Quest.

Grammar Quest

Past simple – to be

was What Was wasn't Yes wasn't was wasn't

Affirmative

1 I was a teacher.

2 He _____ a writer.

Negative

3 I _____ an architect.

4 She _____ a waitress.

Questions and short answers

5 _____ was your favourite subject?

6 _____ he an artist? 7 _____, he was. 8 No, he _____.

2 Read and circle the correct word.

- When I **am** / **was** young, I **was** / **is** a hairdresser.
- What **was** / **not** your favourite subject at school?
- When he **was** / **is** young, he **isn't** / **wasn't** a teacher.
- Am** / **Was** he an architect? Yes, he **was** / **wasn't**.
- When she **was** / **am** young, her favourite subject **wasn't** / **isn't** Maths.

3 Look and complete the sentences using *was* or *wasn't*.

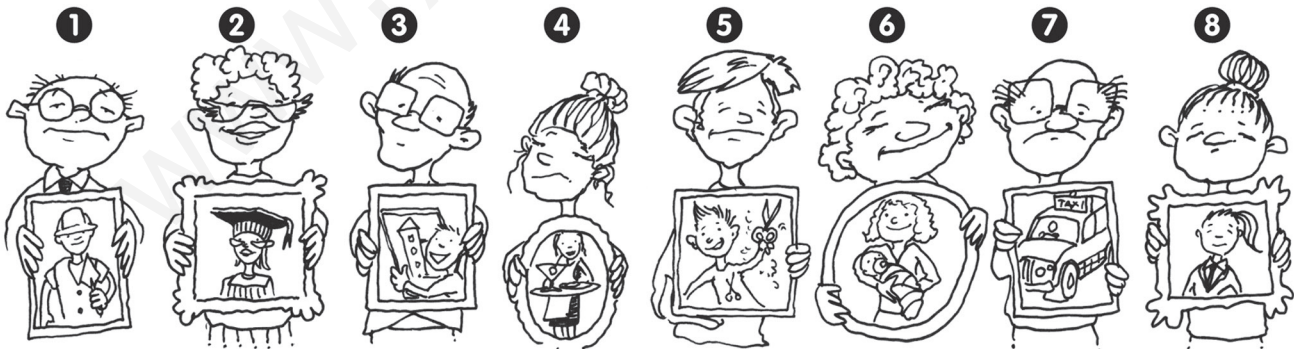

- He was a builder.
- She _____ an artist.
- He _____ a businessperson.
- She _____ a waitress.
- He _____ a writer.
- She _____ a housewife.
- He _____ a taxi driver.
- She _____ a teacher.

13 Complete the sentences.

fingers see same alphabet hands, body and face
Louis Braille hear or speak Gestuno different alphabets

- 1 People who can't see use Braille.
- 2 You use your _____ to read the text.
- 3 There is the _____ for different languages.
- 4 _____ was the inventor.
- 5 People who can't _____ use sign language.
- 6 You use your _____ to communicate.
- 7 There are _____ for different languages.
- 8 _____ is the name of the universal sign language.



14 Write the Braille sentence in English. Then write a sentence in Braille.

• a	•• b	••• c	•••• d	••• e	•••• f	••••• g	•••• h	•••• i	••••• j	•••• k	••••• l	•••••• m
•••• n	•••• o	••••• p	••••• q	••••• r	••••• s	••••• t	••••• u	••••• v	••••• w	••••• x	••••• y	••••• z

--	--	--	--	--	--	--	--	--	--	--	--	--	--	--	--	--	--	--	--

15 Complete the amazing facts. Write the mystery word.

Amazing facts

Braille American swimmer language

Mystery Word! o

- 1 Terence Parkin is an Olympic . He can't hear.
- 2 The book 'Harry Potter and the Goblet of Fire' is 10 books in !
- 3 Sign Language and British Sign are very different.

Quest 5

The world

Vocabulary 1

1 Circle and write the words.



S	T	L	I	V	E
X	A	R	V	D	H
H	L	V	Z	J	E
J	K	I	S	S	L
U	I	S	H	M	P
M	W	I	O	A	K
P	C	T	U	A	W
D	R	W	T	Y	A
H	U	G	L	O	L
A	G	W	O	R	K



Word Quest 1

2 Read and circle the correct word.

- I **helped** / **visited** London last year.
- Sophie **kissed** / **jumped** her grandpa on his birthday.
- My father **talked** / **lived** in Australia when he was a boy.
- Harry **shouted** / **walked** to school this morning.
- The mother **shouted** / **hugged** at her little boy because he was naughty.
- My uncle **visited** / **worked** for a large company in the USA for two years.

3 Read and match. Write the numbers.



- tidy
- look after
- watch
- play
- walk

a film

the dog

the guitar

my brother

my room

Word Quest 2



Grammar Quest

Quest 5

The world

Vocabulary 2

1 Remember the story. Read and complete the sentences. Match.

CHRISTIAN
THE LION

played lived hugged walked helped visited

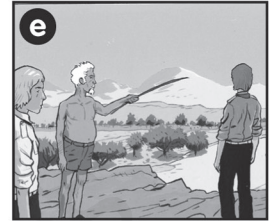
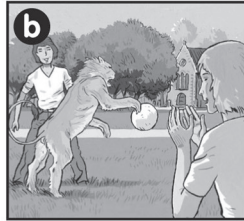

- 1 Christian the lion lived in a shop.
- 2 He _____ football in the churchyard.
- 3 George Adamson _____ Christian meet other lions.
- 4 John and Ace _____ Kenya to see Christian.
- 5 Christian _____ towards them. He jumped and he _____ them.

d
□
□
□
□
□

2 Remember the story. Read and write 'True' or 'False'.

- 1 Christian the lion was from a big shop in London called Harrods. True
- 2 Christian lived in a house with John and Ace. _____
- 3 The lion travelled to Kenya to live when he was one year old. _____
- 4 John and Ace helped Christian meet other lions in Kenya. _____
- 5 When John and Ace visited Kenya again, Christian hugged and kissed them. _____
- 6 Christian didn't remember John and Ace. _____

3 Remember the story. Read and write the short answers.



- 1 Did John work in Harrods? No, he didn't.
- 2 Did Christian the lion live in a shop? _____
- 3 Did Christian play basketball? _____
- 4 Did Christian meet other lions in Kenya? _____
- 5 Did George Adamson visit Christian in London? _____
- 6 Did Christian remember John and Ace? _____

1 Read and complete the Grammar Quest.

Grammar Quest

Past simple

shouted Did didn't walked work did

Affirmative

- 1 I walked in the park.
- 2 He/She _____ at me.

Questions

- 3 _____ you live in Spain?
- 4 Did he/she _____ hard at school?

Short answers

- 5 Yes, I _____.
- 6 No, he/she _____.

2 Read and circle the correct word.

- 1 Yesterday, I **walk** / **walked** to school.
- 2 Yesterday, he **visits** / **visited** his grandma's house.
- 3 Yesterday, she **hugged** / **hugging** her grandpa.
- 4 Yesterday, he **helps** / **helped** his mum.
- 5 **Did** / **Do** you walk to the shops yesterday?
- 6 Did you **talk** / **talked** in English in class?

3 Look and complete the sentences using the past simple.



- 1 He talked to his friend.
- 2 She _____ her baby sister.
- 3 He _____ to the shops.
- 4 She _____ her grandma.
- 5 He _____ his mum.
- 6 She _____ her grandma.

13 Complete the sentences.

air food habitat water

- 1 People and animals need clean water to drink.
- 2 People and animals need _____ to eat.
- 3 People and animals need clean _____ to breathe.
- 4 People and animals need a safe _____ to live in.



14 Match the sentences to the pictures.



- a She planted a tree.
- b I picked up rubbish.
- c We recycled our rubbish.

15 Complete the sentences.

- 1 walk / school Yesterday, I walked to school.
- 2 adopt / tiger Yesterday, we _____.
- 3 pick up / rubbish Yesterday, they _____.
- 4 recycle / glass bottles Yesterday, I _____.
- 5 plant / trees Yesterday, he _____.



16 Complete the amazing facts. Write the mystery word.

Amazing facts

trees water shower recycle

- 1 If you _____ 1000 kg of paper, you help save 15 _____.
- 2 A bath uses about 250 litres of _____. A 5-minute _____ uses about 75 litres of water.

Mystery Word!

□ □ □ □ d

Quest 5

Holidays

Vocabulary 1

1 Look and match.

Word Quest 1

- 1 a supermarket a 2 a bookshop 3 a hotel 4 a tourist office 5 an aquarium

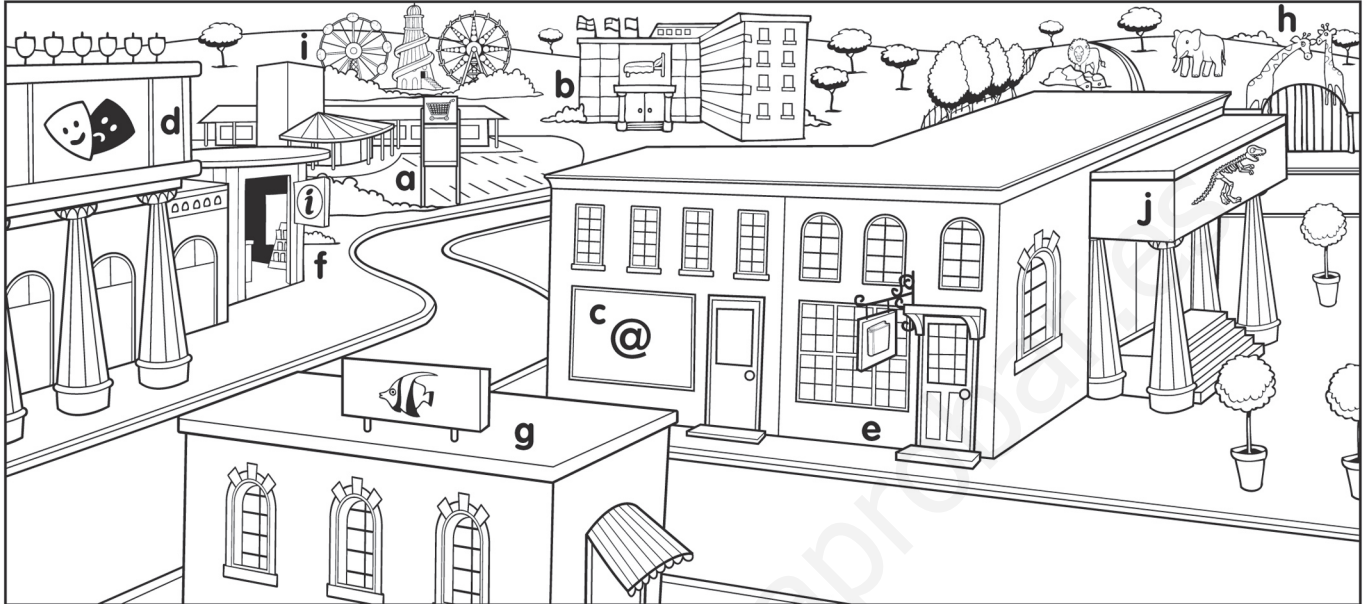

- 6 a zoo 7 a museum 8 a funfair 9 an internet café 10 a theatre

2 Write the words.

- | | | | |
|------------------|-----------------|-----------------|-------|
| 1 ozo | _____ zoo _____ | 6 kupmersaret | _____ |
| 2 qirmuaua | _____ | 7 nertinte facé | _____ |
| 3 ranffui | _____ | 8 summue | _____ |
| 4 stirout ofecif | _____ | 9 reathet | _____ |
| 5 lehot | _____ | 10 pokbosho | _____ |

3 Look. Write the words.

Word Quest 2

ferry double-decker bus taxi high speed train underground

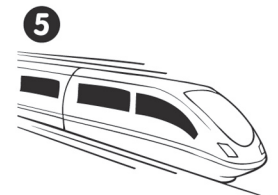
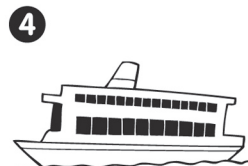
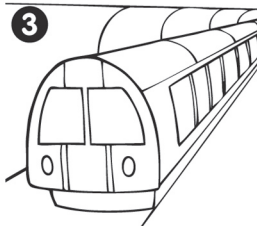
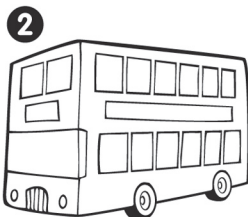

a taxi a _____ the _____ a _____ a _____



1 Remember the story. Read and match.

- 1 Beatrice wants to see the Statue of Liberty and the zoo.
- 2 Thank you. Now let me help you.
- 3 Well, I don't want to walk! What about the tourist bus?
- 4 She's got your bag!
- 5 Wait. This isn't my bag!

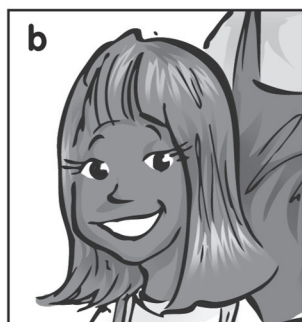
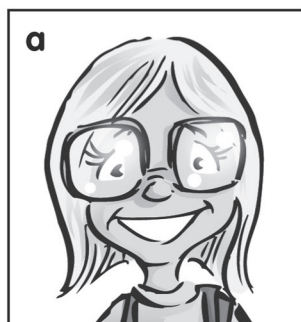

2 Remember the story. Read and circle the correct answer.



- 1 Adrian **wants** / **doesn't want** to walk.
- 2 Beatrice **doesn't want** / **wants** to see the Statue of Liberty.
- 3 Karen **wants** / **doesn't want** to see the zoo.
- 4 Adrian **doesn't want** / **wants** to take the tourist bus.
- 5 They **want** / **don't want** to follow the girl in a taxi.
- 6 Annabelle Page **wants** / **doesn't want** to help the children.

3 Remember the story. Read and write the short answers.

- 1 Does Karen want to visit the Museum of Modern Art? Yes, she does.
- 2 Does Adrian want to walk? _____
- 3 Does Adrian want to go on the tourist bus? _____
- 4 Does Beatrice want to go to a funfair? _____
- 5 Does the taxi driver help the children? _____
- 6 Does Annabelle Page take the children on a visit of New York? _____

1 Read and complete the Grammar Quest.

Grammar Quest

Future – want to + verb – he/she

wants want doesn't does doesn't Does want to wants to

Affirmative

- 1 He wants to go to the zoo.
2 She _____ go to the aquarium.

Negative

- 3 He _____ want to go to the funfair.
4 She doesn't _____ to go to the theatre.

Questions and short answers

- 5 _____ he want to go to the museum? 6 Yes, he _____.
7 Does she _____ go to the bookshop? 8 No, she _____.

2 Read and circle the correct word.

- 1 I want / wants to go to the zoo. 4 Does / Do you want to go to the supermarket?
2 She wants / want to go to the funfair. 5 Does she want / wants to go to the museum?
3 He don't / doesn't want to go to the hotel. 6 Does / Do he want to go to the theatre?

3 Look and complete the sentences.

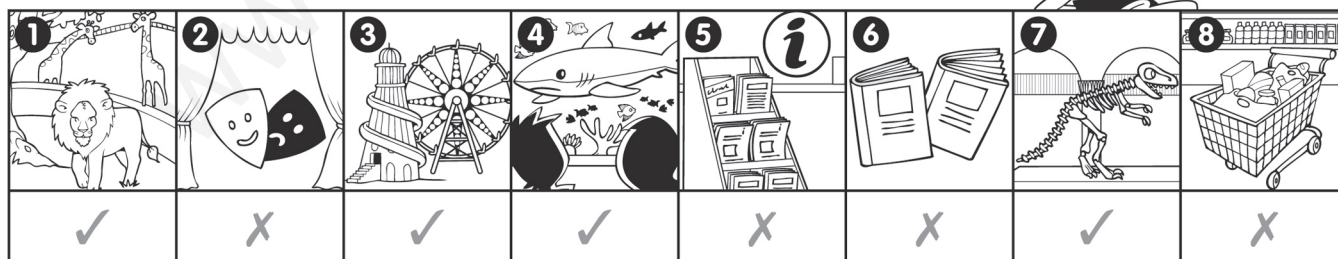

- 1 She wants to go to the zoo. 5 She _____ go to a tourist office.
2 She _____ go to the theatre. 6 She _____ go to a bookshop.
3 She _____ go to the funfair. 7 She _____ visit a museum.
4 She _____ visit the aquarium. 8 She _____ go to the supermarket.

13 Write the answers.

27 10 19,300 km

- 1 How many GPS satellites are there in space? About _____
- 2 How many kilometres from the Earth are the GPS satellites? _____
- 3 How many years does a GPS satellite last? _____



14 Unscramble the words and write. Match.

- 1 GPS can help people who can't **ese** see.
- 2 It can help **rfei** _____ fighters.
- 3 It can help ambulance **vriedsr** _____.
- 4 It can help people who **lkaw** _____ in the mountains.
- 5 It can help people who travel by **cra** _____.



a

b

c 1

d

e

15 Listen and circle the correct answers.

- 1 Sophie's mum and dad have got a GPS in the ... a) job b) car c) house
- 2 Sophie's dad thinks the GPS is ... a) fun to use b) difficult to use c) easy to use
- 3 Sophie wants a GPS collar for her ... a) cat b) dog c) horse

I've got a GPS ...
What about you?



16 Complete the amazing facts. Write the mystery word.

Amazing facts

cats collar animals

1 You can buy a GPS _____ for dogs or _____.

2 Scientists use GPS to study how _____ live.

Mystery Word!

□ □ □ e □ □ □ t e