



Reinforcement & Extension worksheets

www.yoquieroaprobar.es

➔ Look and circle.



jump / run



rollerblade / dance



climb / jump



ride a bike / dance

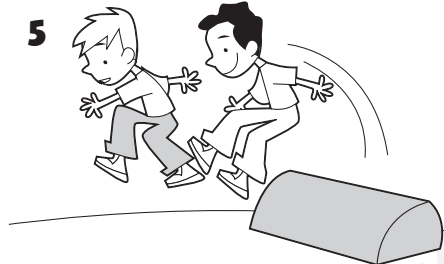

jump / rollerblade



run / ride a bike

➔ Look and write.

ride a bike ~~dance~~ jump rollerblade run climb



1 I can dance.

4 I can _____.

2 I can't _____.

5 I can _____.

3 I can't _____.

6 I can't _____.

➡ Circle. ➡ Write.

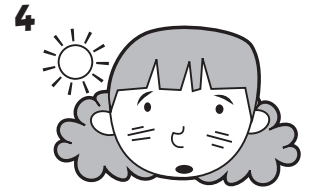

angry



➡ Write.

~~cold~~ hot thirsty cold ~~hungry~~ hot
happy hot sad angry cold tired

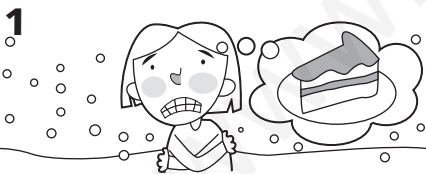

I'm cold.

I'm hungry.

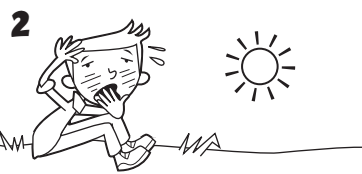

I'm _____.

I'm _____.



I'm _____.

I'm _____.



I'm _____.

I'm _____.

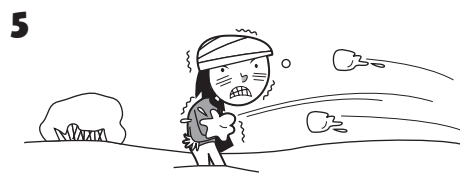

I'm _____.

I'm _____.



I'm _____.

I'm _____.

➔ Write.

bus lorry taxi plane train motorbike



lorry



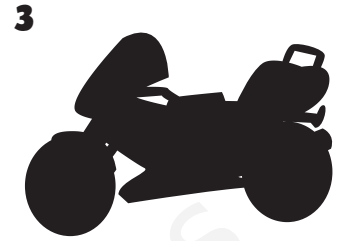



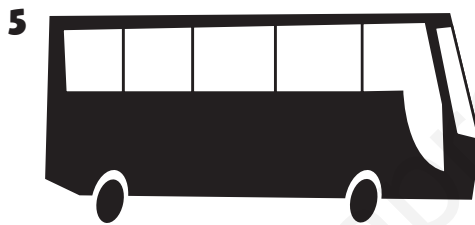



➔ Look and write. ➔ Read and colour.

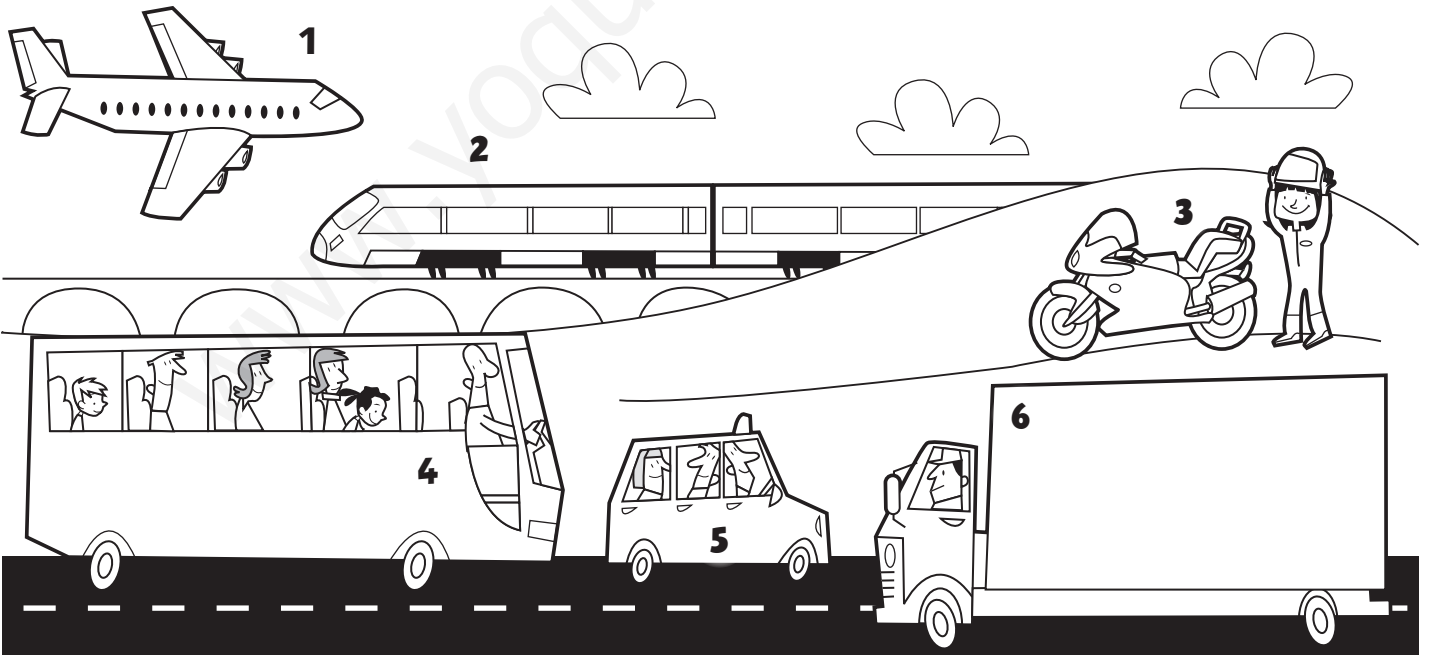

- 1 It's a yellow plane. 4 It's a red _____.
- 2 It's a blue _____.
- 3 It's a pink _____.
- 5 It's a brown _____.
- 6 It's a green _____.

➔ Write.

big fast ~~long~~ old new short slow small

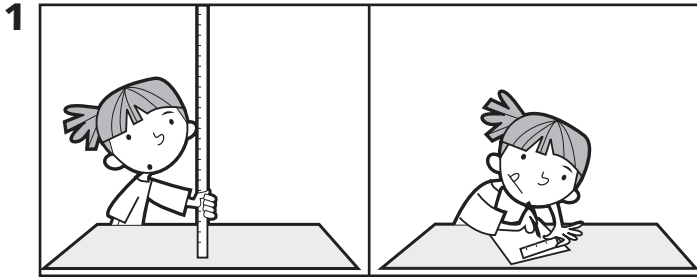

long

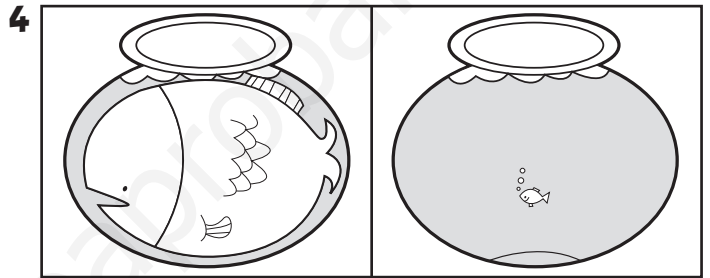
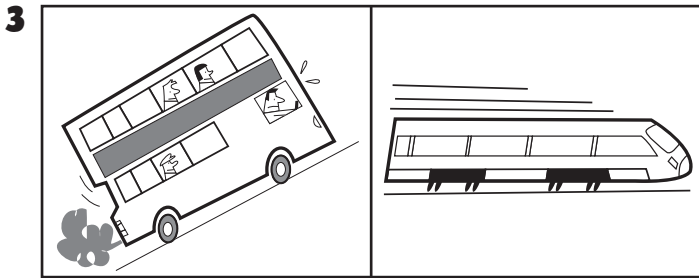
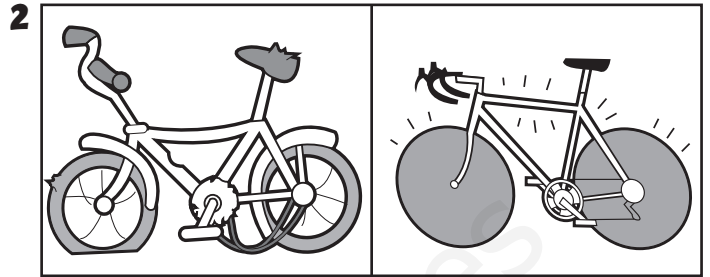

➔ Look and write.

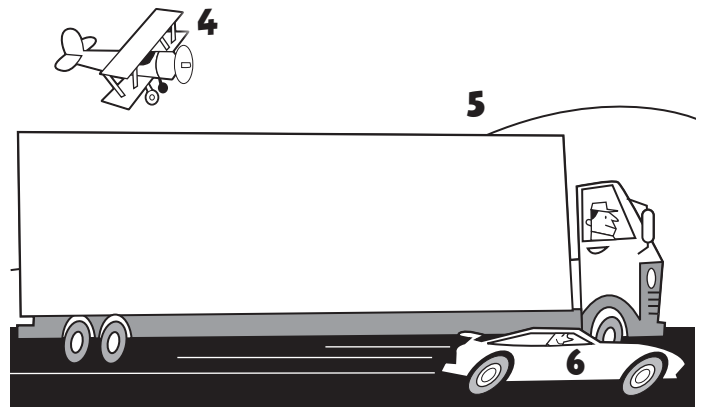
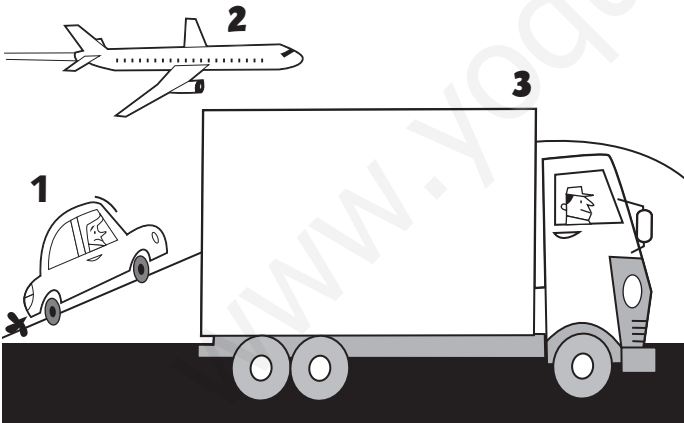

plane ~~slow~~ big

long fast old

1 It's a slow car.

4 It's an _____.

2 It's a new _____.

5 It's a _____.

3 It's a _____ lorry.

6 It's a _____.

➔ Look and write.

bedroom kitchen ~~hall~~ garden bathroom living room

1  **1**▶ h a l l

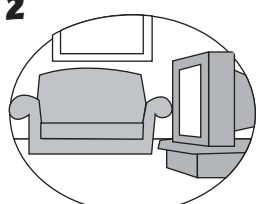
2  **2**▶

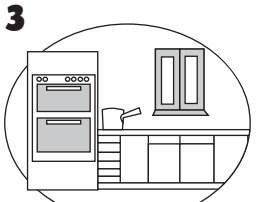

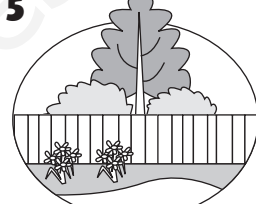

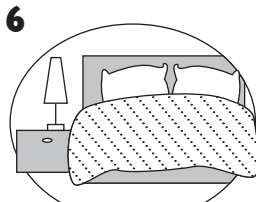

3  **3**▶





4  **4**▶

5  **5**▶

6  **6**▶

➔ Follow and write.

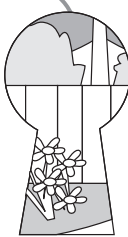
1  **2**  **3**  **4**  **5**  **6** 

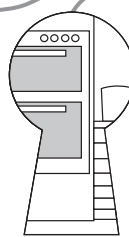
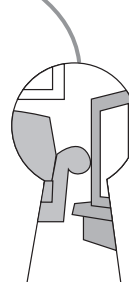
1  **2**  **3**  **4**  **5**  **6** 

- 1 She's in the bedroom. 4 She's in the _____.
- 2 He's in the _____.
- 3 She's in the _____.
- 5 He's in the _____.
- 6 He's in the _____.

➔ Look and write.

bed bird box cupboard flowers table tree scooter

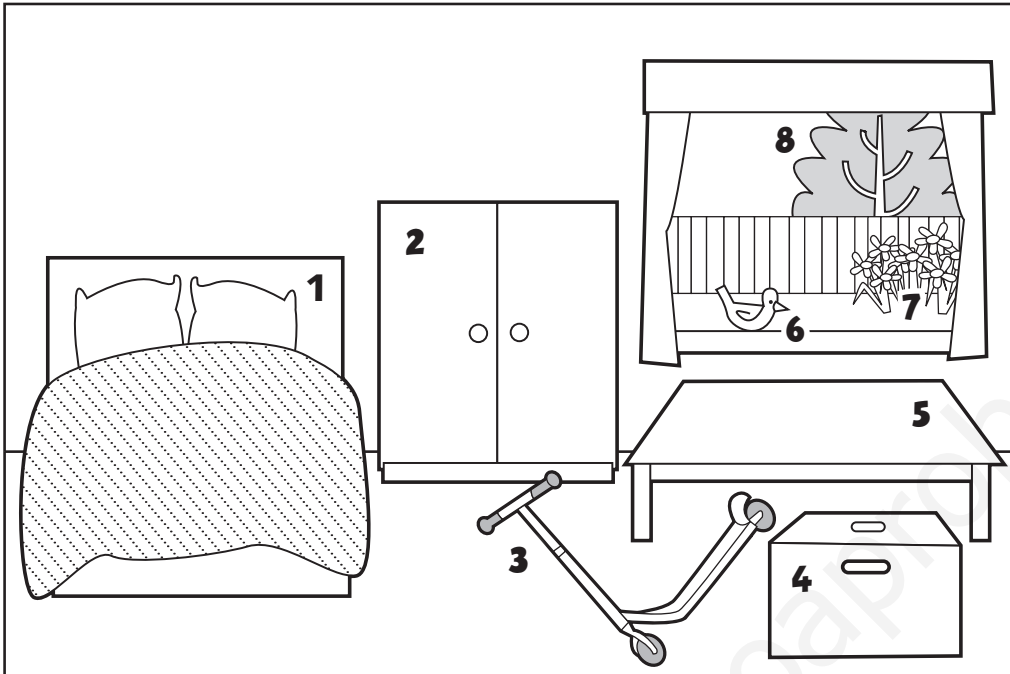

- 1 bed
- 2 _____
- 3 _____
- 4 _____
- 5 _____
- 6 _____
- 7 _____
- 8 _____

➔ Circle and write.

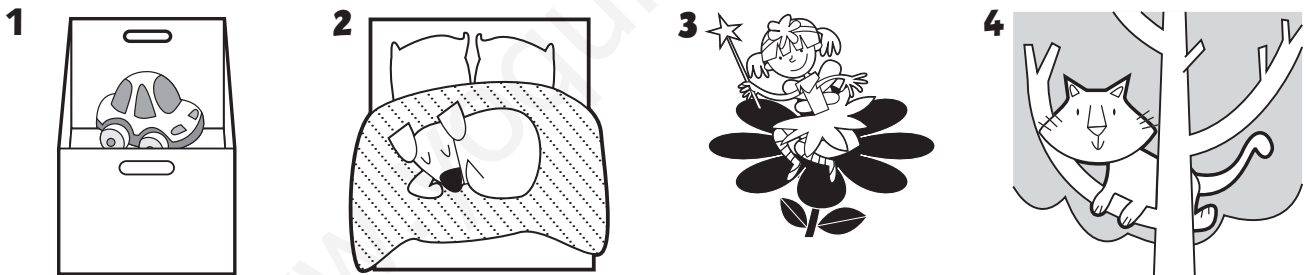

- 1 The car is **in** / on the box.
- 2 The dog is **in** / on the _____.
- 3 The girl is **in** / on the _____.
- 4 The cat is **in** / on the _____.
- 5 The _____ is **in** / on the _____.
- 6 The _____ is **in** / on the _____.

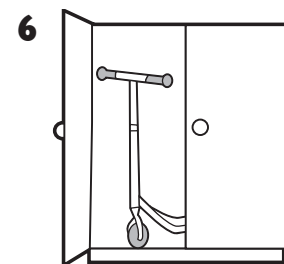
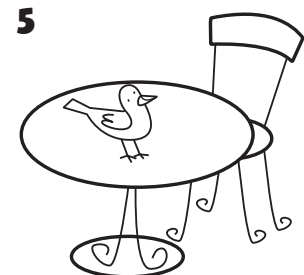

➔ Write.

snake fox bat mouse frog hedgehog

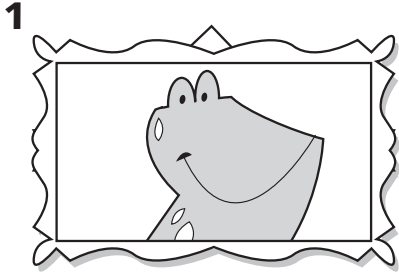

frog

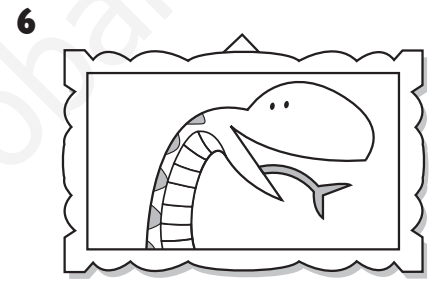
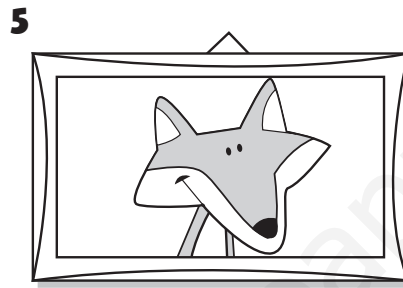
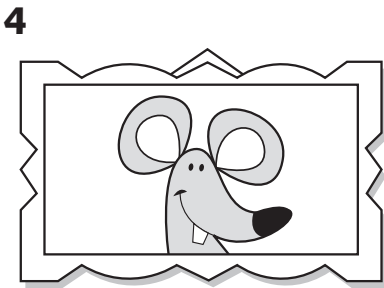
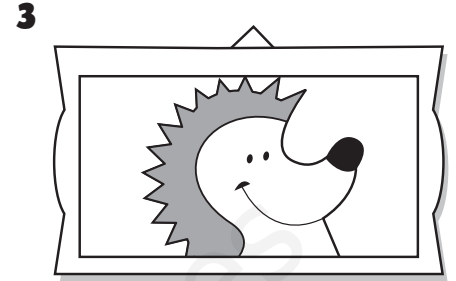
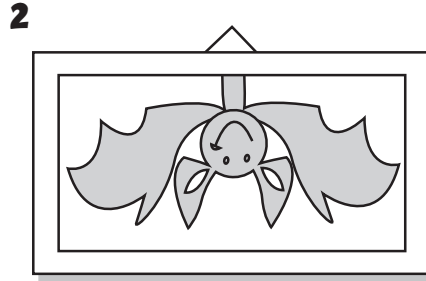

➔ Look and write. ➔ Read and circle.

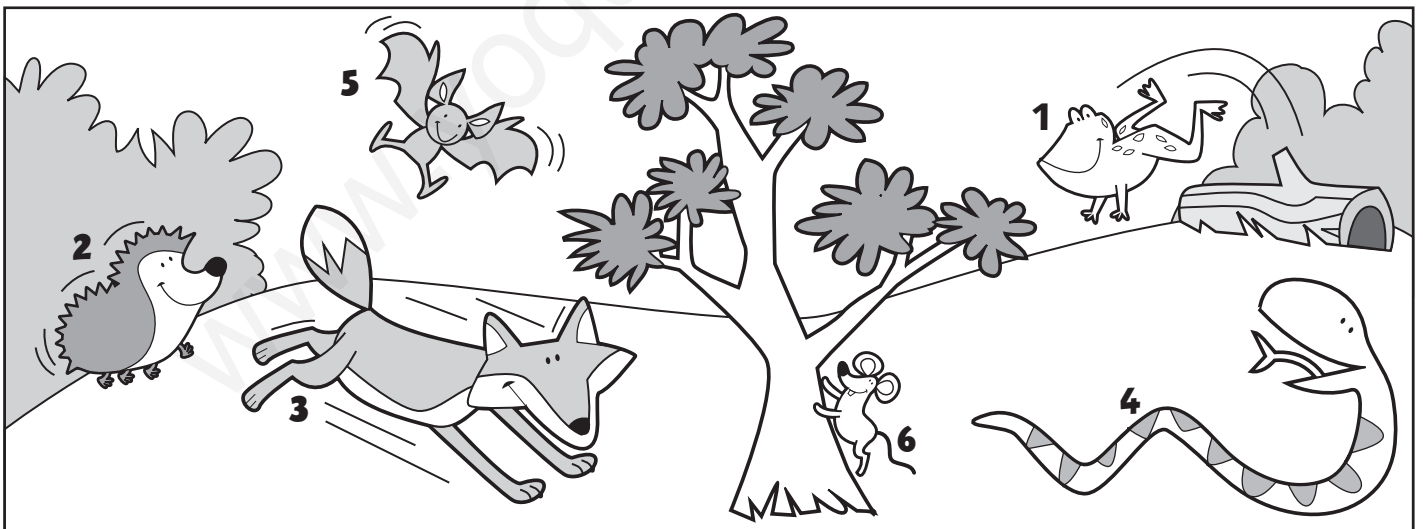

1 frog It can / can't jump.

4 _____ It can / can't jump.

2 _____ It can / can't fly.

5 _____ It can / can't run.

3 _____ It can / can't run.

6 _____ It can / can't climb.

➔ Write.

jump climb run fly swim walk hop sing

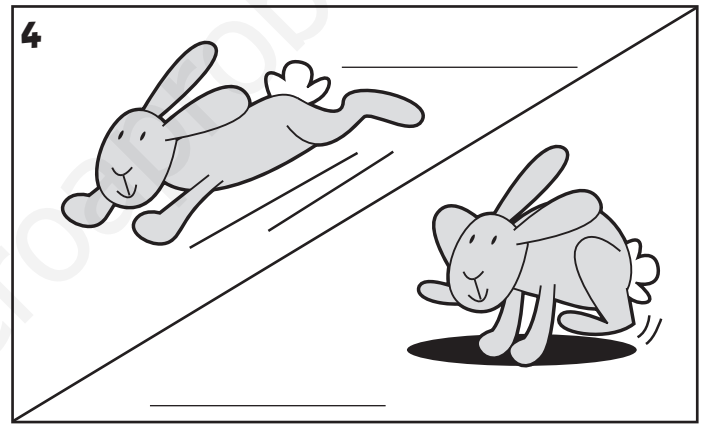
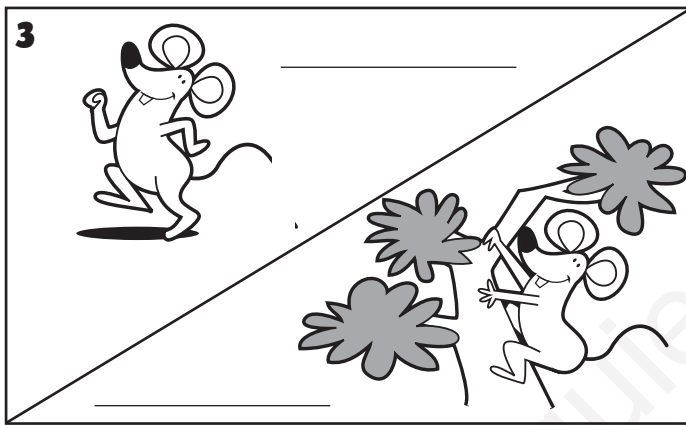
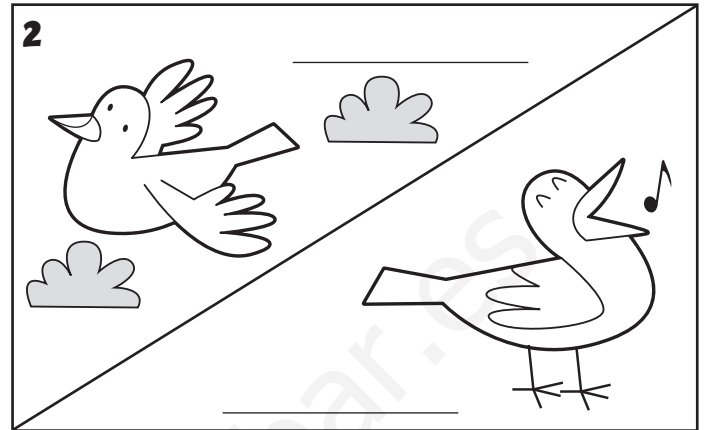
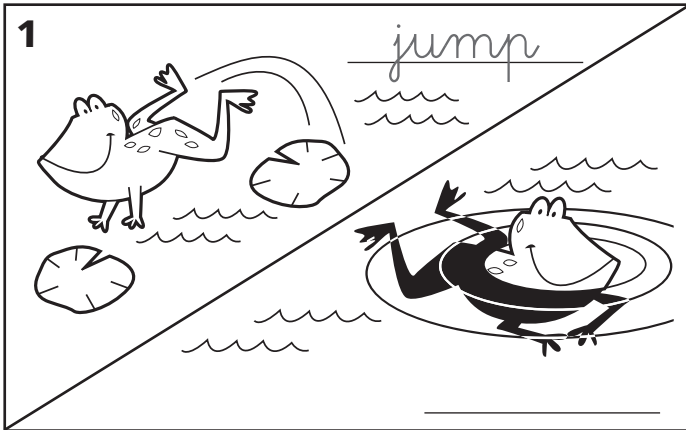

➔ Look and write.

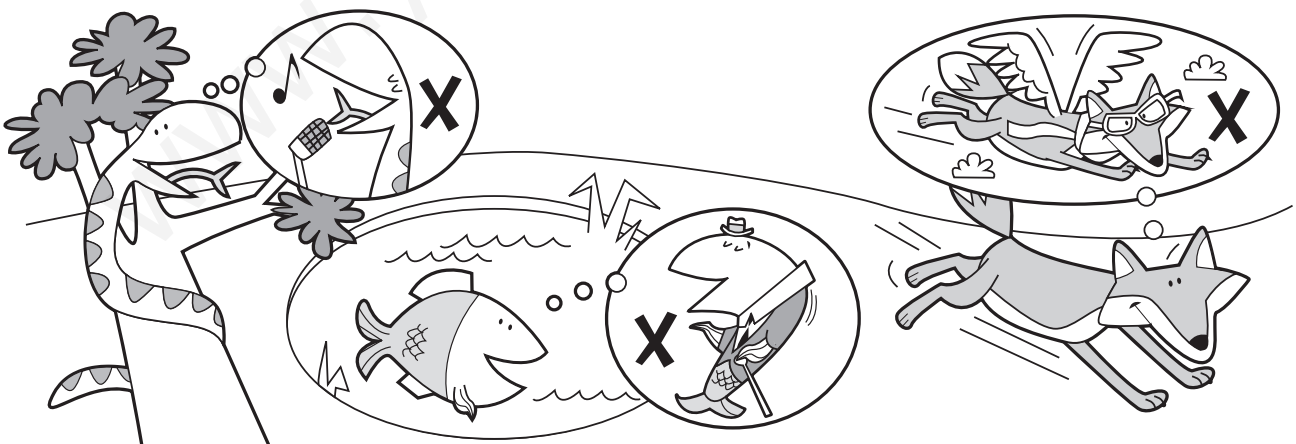

1 There's a snake. It can climb. It can't _____.

2 There's a fish. It can _____. It can't _____.

3 There's a fox. It can _____. It can't _____.

➔ Follow and write.

teeth wings legs tail arms head

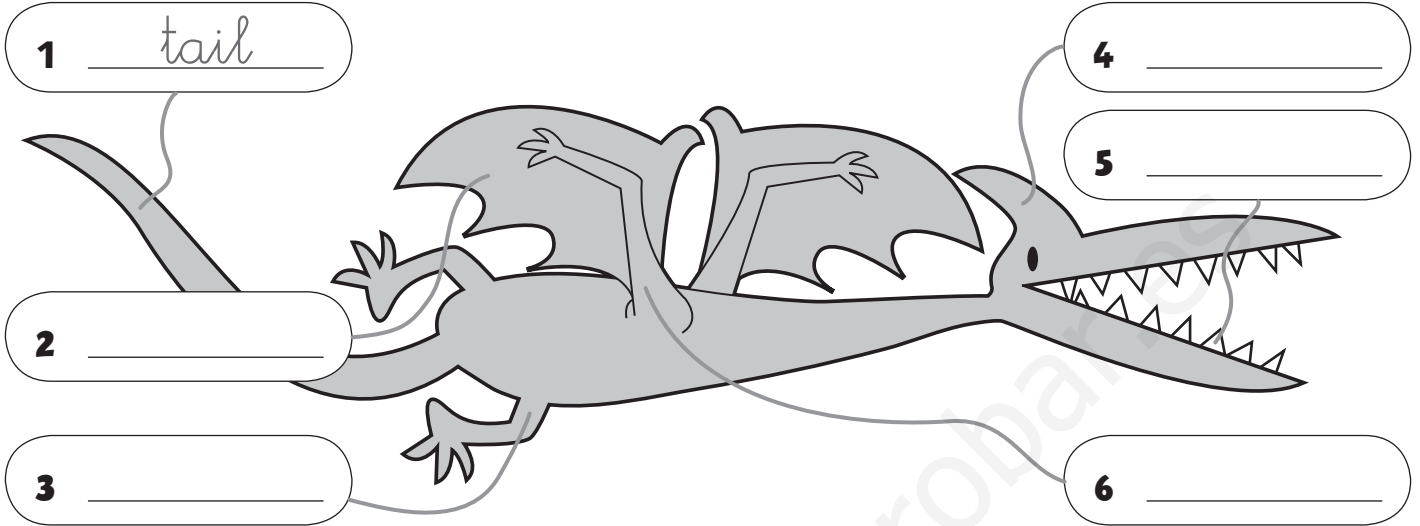

➔ Look and write. ➔ Read and match.

1 It's got wings.
It hasn't got _____.

2 It's got _____.
It hasn't got a _____.

3 It's got _____.
It hasn't got _____.

4 It's got _____.
It hasn't got _____.

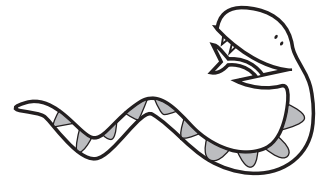

➔ Look and write.

ears mouth eyes arms nose tail head wings

➔ Look and write.

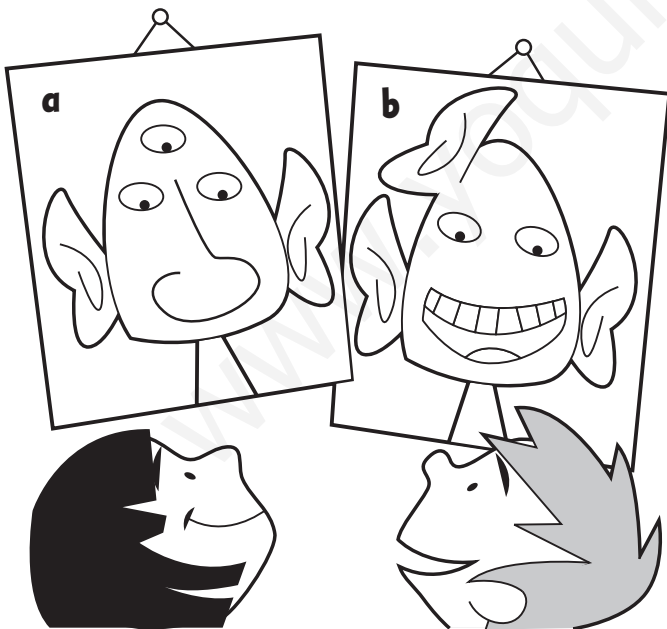

a It's got 2 ears.
 It's got 1 _____.
 It's got 3 _____.
 It hasn't got a _____.

b It's got 2 _____.
 It's got 1 _____.
 It's got 3 _____.
 It hasn't got a _____.

➔ Look and colour.



= blue

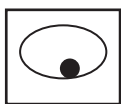

= red



= orange

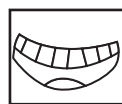

= yellow

➔ Circle. ➔ Write.

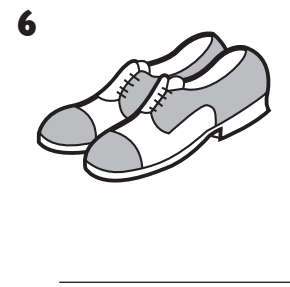
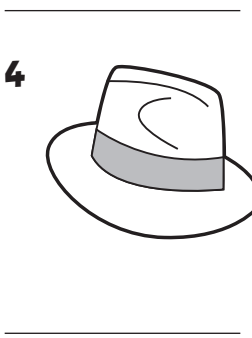
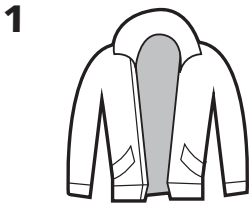

T-shirt

➔ Look and write. ➔ Read and colour.

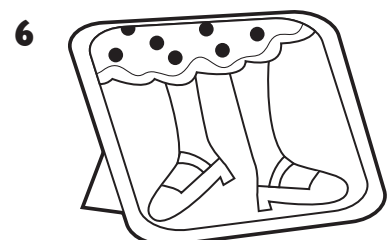
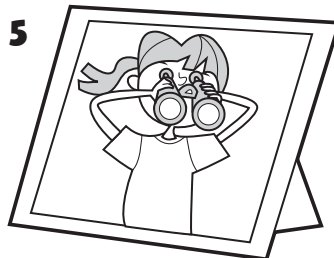
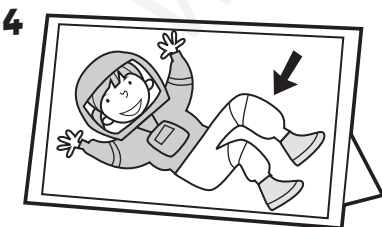

- 1 I'm wearing a blue jacket. 4 I'm wearing pink _____.
- 2 I'm wearing a yellow _____. 5 I'm wearing a green _____.
- 3 I'm wearing a red _____. 6 I'm wearing black _____.

➔ Write.

jacket skirt shoes T-shirt jumper boots dress shorts

1 skirt

2 _____

3 _____

4 _____

5 _____

6 _____

7 _____

8 _____

➔ Look and write.

➔ Draw and write for you.

I'm wearing a
dress and
a _____.

I'm wearing a
_____ and
_____.

I'm wearing _____

_____.

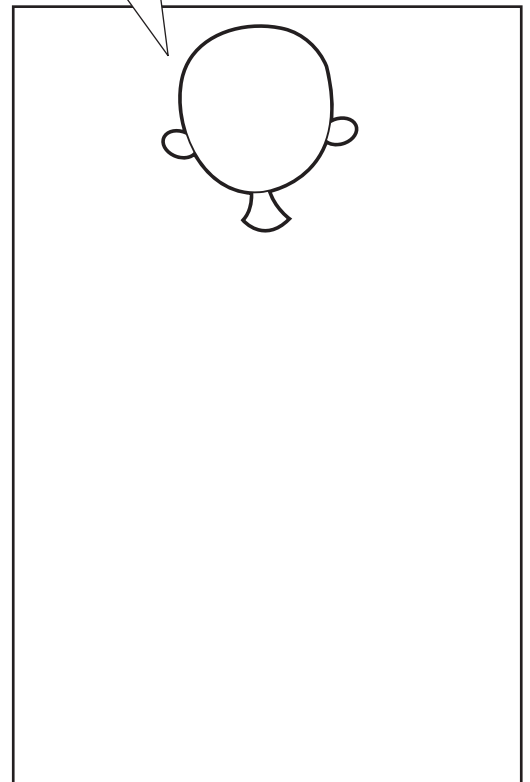

➔ Write. ➔ Match.

i u o a a i e u

- 1 cl i m b
- 2 r _ l l e r b l _ d e
- 3 j _ m p
- 4 r _ d e a b i k _
- 5 d _ n c e
- 6 r _ n

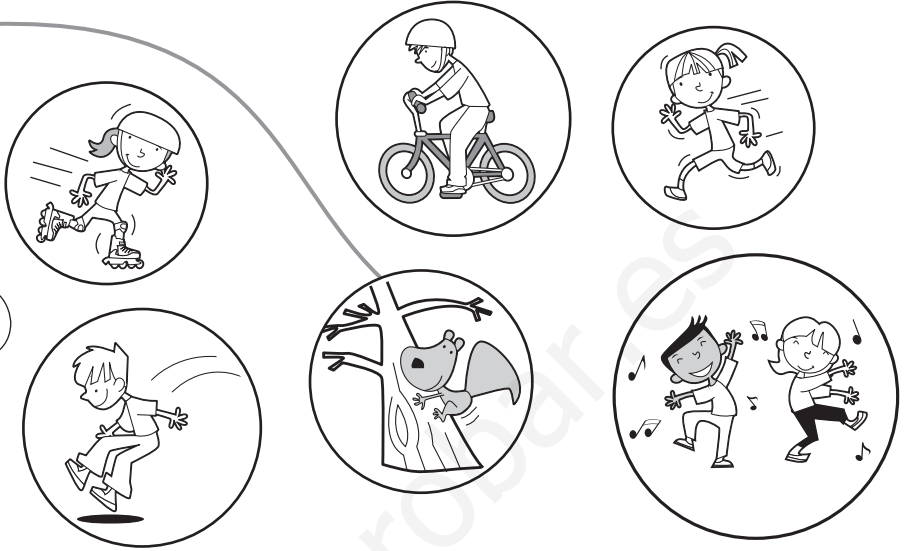

➔ Look, circle and write.



I can / can't climb.



I can / can't _____.



I can / can't _____.



I can / can't _____.



I can / can't _____.



I can / can't _____.

➔ Write. ➔ Find and circle.

aaa e ii oo u



hungry



c__ld



t__r__d

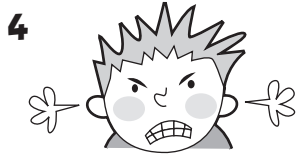

__ngry

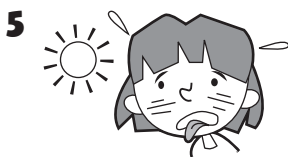

h__t



s__d



h__ppy



th__rsty

s	f	c	o	t	i	r	e	d	t
a	h	u	n	g	r	y	l	w	h
d	a	n	a	n	v	e	m	y	i
u	t	s	n	g	c	o	l	d	r
e	h	i	g	o	s	r	d	a	s
s	o	n	r	d	k	y	p	e	t
h	t	p	y	h	a	p	p	y	y

➔ Write. ➔ Read and match.

1 I'm **oht** hot
and **ngrya** angry.

2 I'm **cd** _____
and **nhu**gry _____.

3 I'm **oldc** _____
and **ppy**h_____.

4 I'm **dirt** _____
and **thst** _____
tiry _____.

5 I'm **oth** _____
and **dsa** _____.



➔ Look and write.

train plane lorry bus motorbike taxi

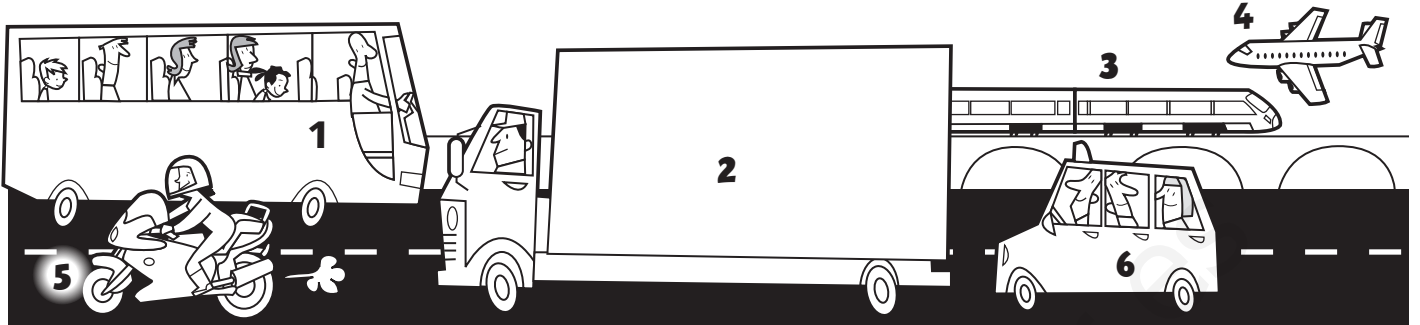

1 bus 2 _____ 3 _____

4 _____ 5 _____ 6 _____

➔ Look and colour. ➔ Write.

= red
 = green
 = brown
 = blue
 = orange
 = yellow

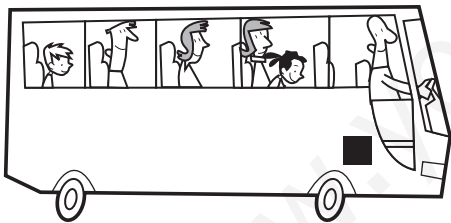

1 It's a red bus. 2 It's a _____.

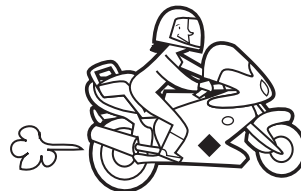

3 It's a _____.

4 It's an _____.

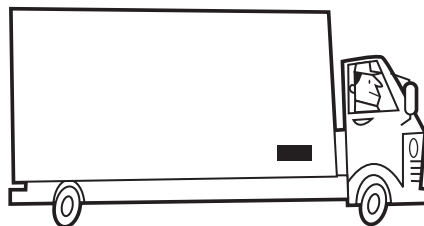

5 It's a _____.

6 It's a _____.

➔ Write.

w ng d w ll g st rt

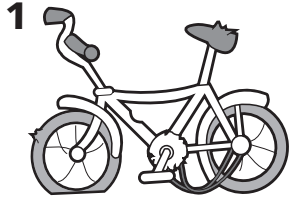

old



lo

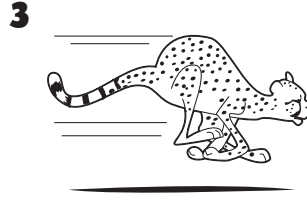

fa

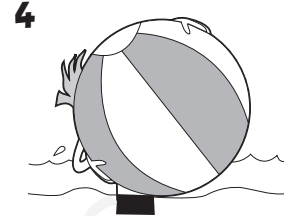

bi

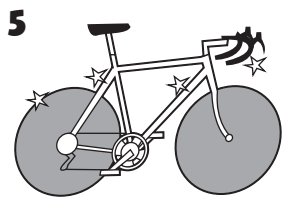

ne

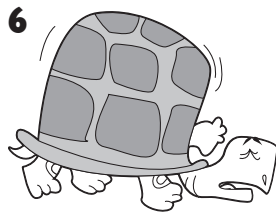

slo

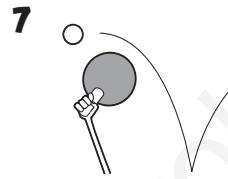

sm a



sho

➔ Write.

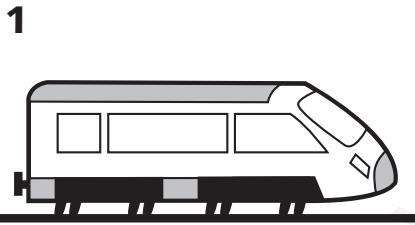

It's a *short*
train.

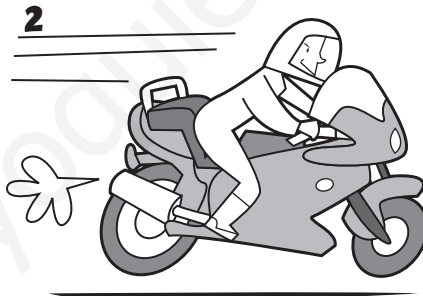

It's a

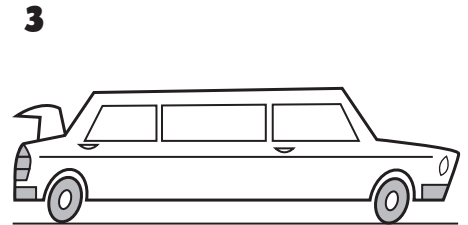

It's a



It's a

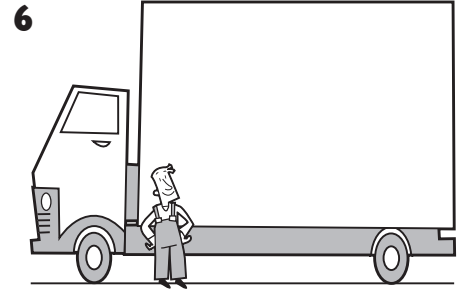
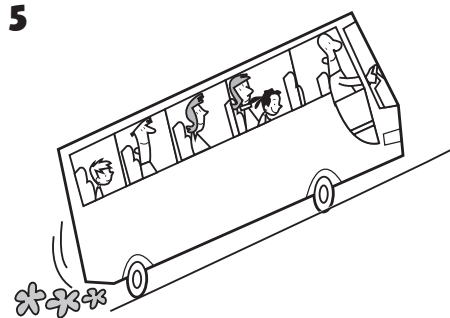

➔ Look and write.

a a a

e e e

i i i

o o o o o

1 b a t h r o o m

2 b _ _ d r _ _ _ m

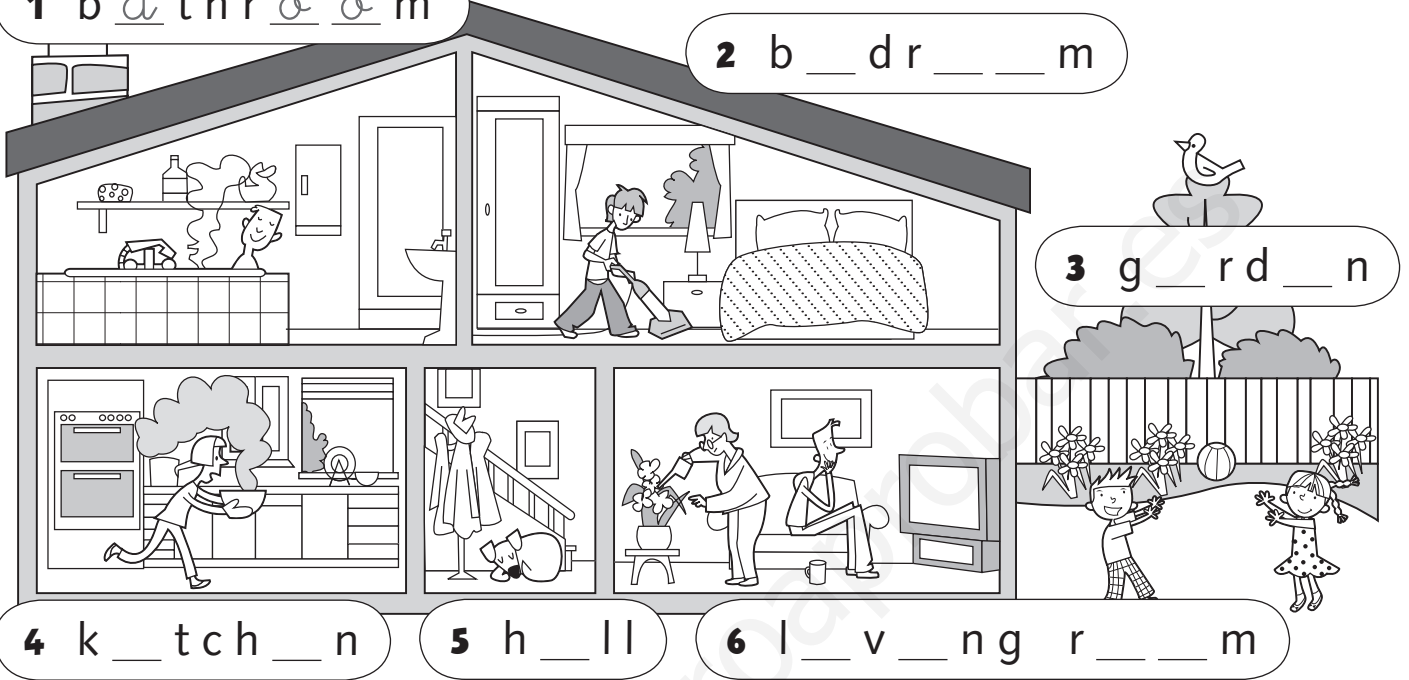

3 g _ _ r d _ _ n

4 k _ _ t c h _ _ n

5 h _ _ l l

6 l _ _ v _ _ n g r _ _ _ m

➔ Look and write.

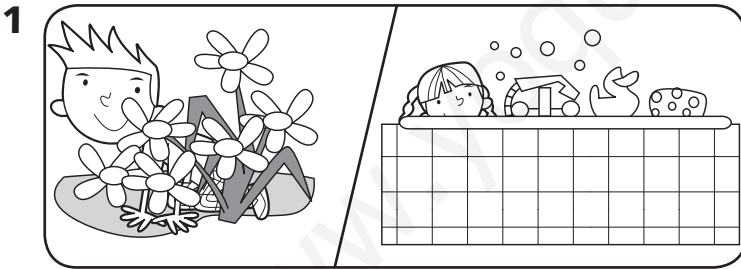

He's in the garden.

She's in the _____.

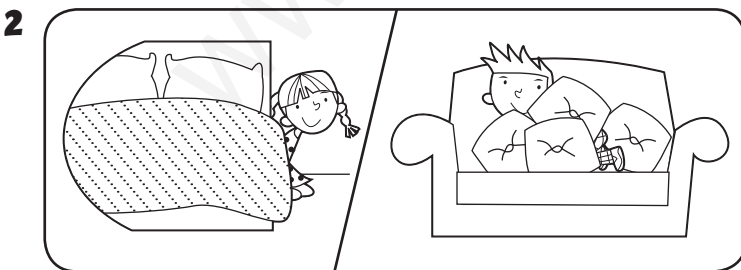

_____ in the _____.

_____ in the _____.

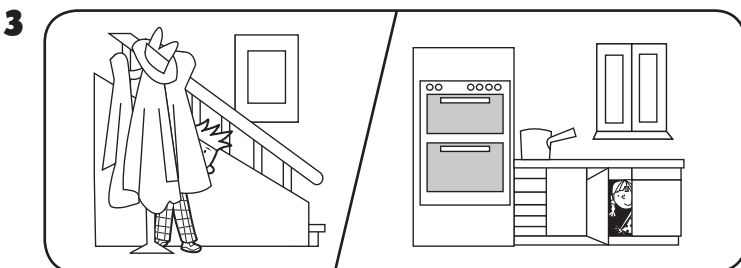

_____ in the _____.

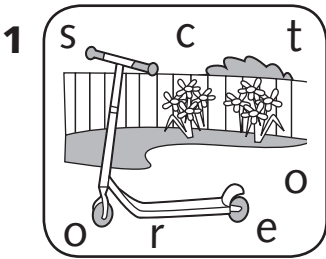

_____ in the _____.

➔ Write. ➔ Complete the table.

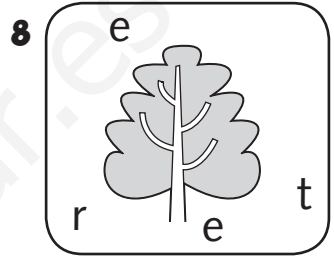
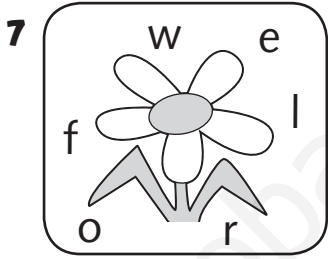
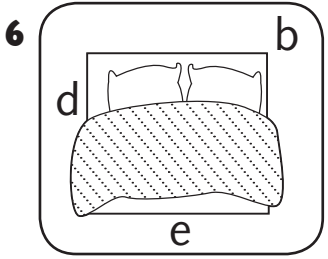
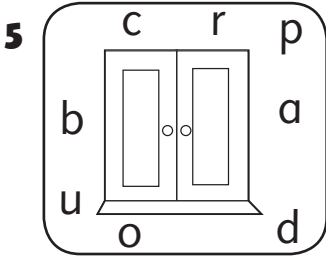
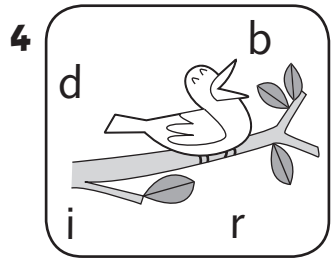
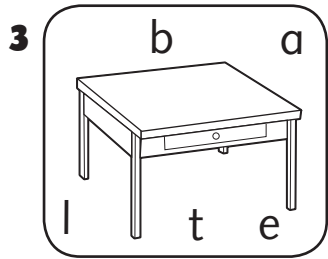
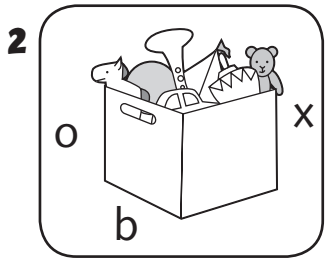

scooter



 house				
 garden	<i>scooter</i>			

➔ Look and write.

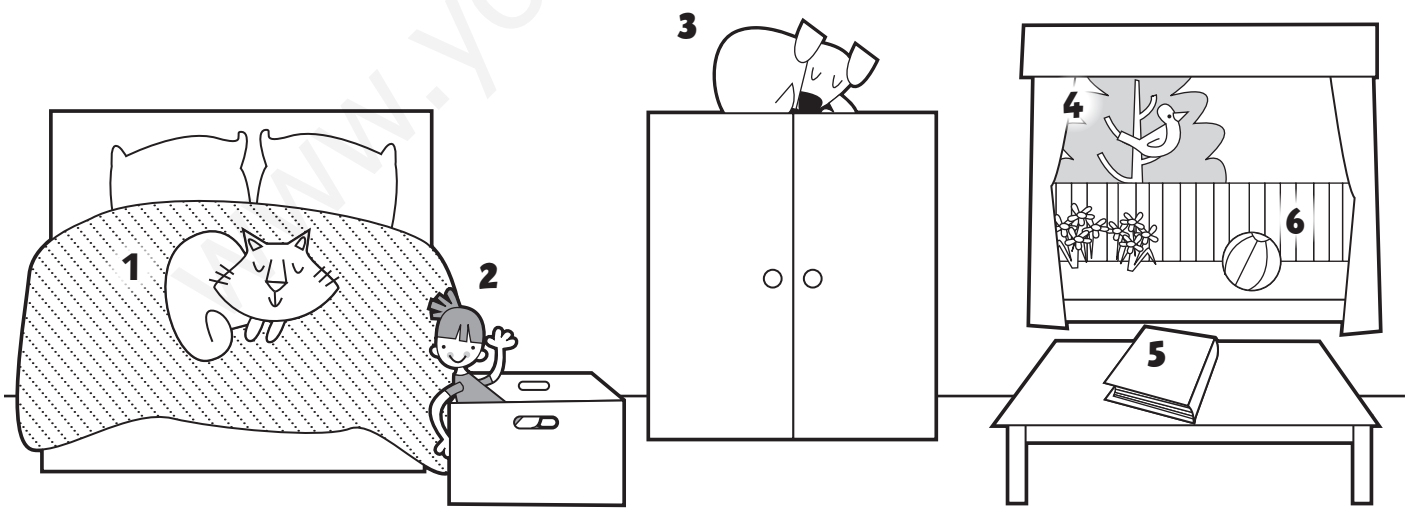

- 1 The cat is on the bed. 4 The bird is in the cage.
- 2 The doll is in the box. 5 the table.
- 3 The dog is on the wardrobe. 6 a ball.

➔ Write. ➔ Find and circle.

a a

e e e e

o o o o

u

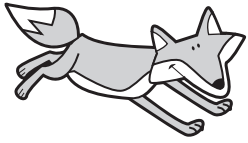

1 f o x



2 m _ _ s _ _



3 s n _ _ k _ _



4 fr _ _ g



5 b _ _ t

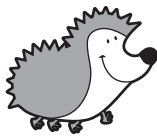

6 h _ _ d g _ _ h _ _ g

l	u	b	b	i	d	e	m	f
o	s	n	a	k	e	b	o	o
n	i	h	d	e	f	a	i	x
f	r	o	g	m	c	t	p	e
e	a	d	m	o	u	s	e	d
s	h	e	d	g	e	h	o	g

➔ Look and write. ➔ Choose *can* or *can't*. ➔ Read and colour.

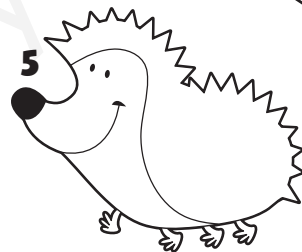
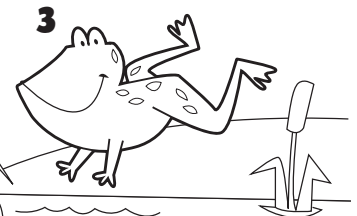
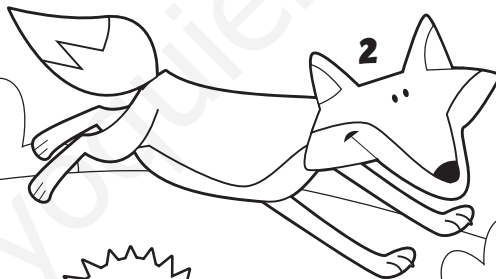

1 There's a black bat.
It can't hop.

4 There's a brown _____.
It _____ run.



2 There's a red _____.
It _____ ride a bike.



5 There's a grey _____.
It _____ dance.

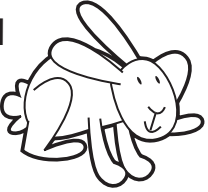

3 There's a yellow _____.
It _____ jump.

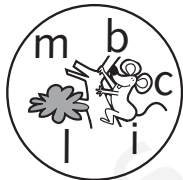

6 There's a green _____.
It _____ rollerblade.

➔ Follow and write.

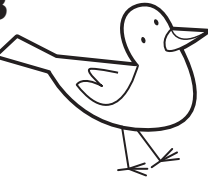
1   

2   

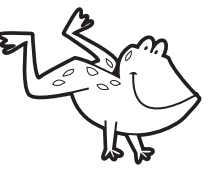
3   

4   

➔ Choose and write *can* or *can't*.

1  rollerblade climb
 It's a snake.
 It can climb.
 It can't rollerblade.



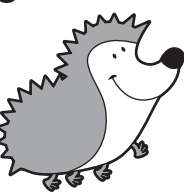



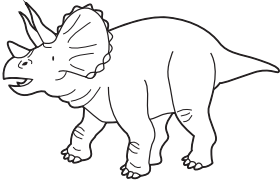
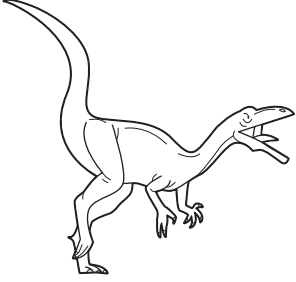

2  fly swim
 It's a _____.
 It _____.
 It _____.

3  dance walk
 It's a _____.
 It _____.
 It _____.

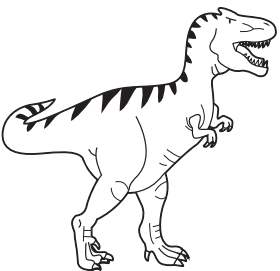
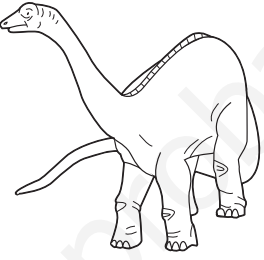
4  run sing
 It's a _____.
 It _____.
 It _____.

➔ Write. ➔ Match.

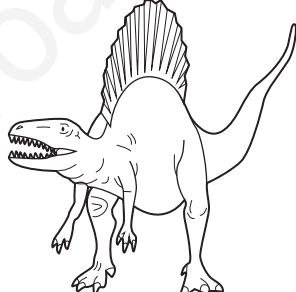
il gs th gs ad ms

<p>1 wings _____</p> 			<p>4 le _____</p> 
<p>2 he _____</p> 			<p>5 tee _____</p> 
<p>3 ar _____</p> 			<p>6 ta _____</p> 

➔ Write.

1

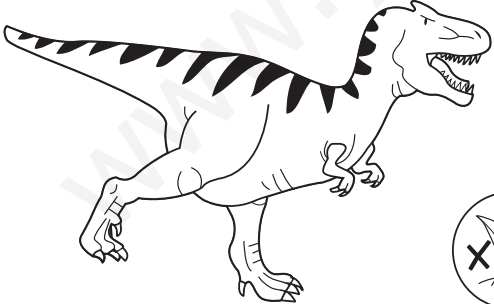

It's got short arms.

It's got 2 _____.

It's got big _____.

It hasn't got _____.



2

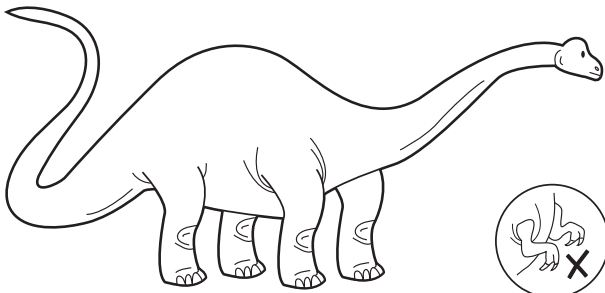

It's got a small _____.

It's got a long _____.

It's got 4 _____.

It hasn't got _____.



➔ Follow and write. ➔ Find and circle.

o a a a e e e e e i i o o u

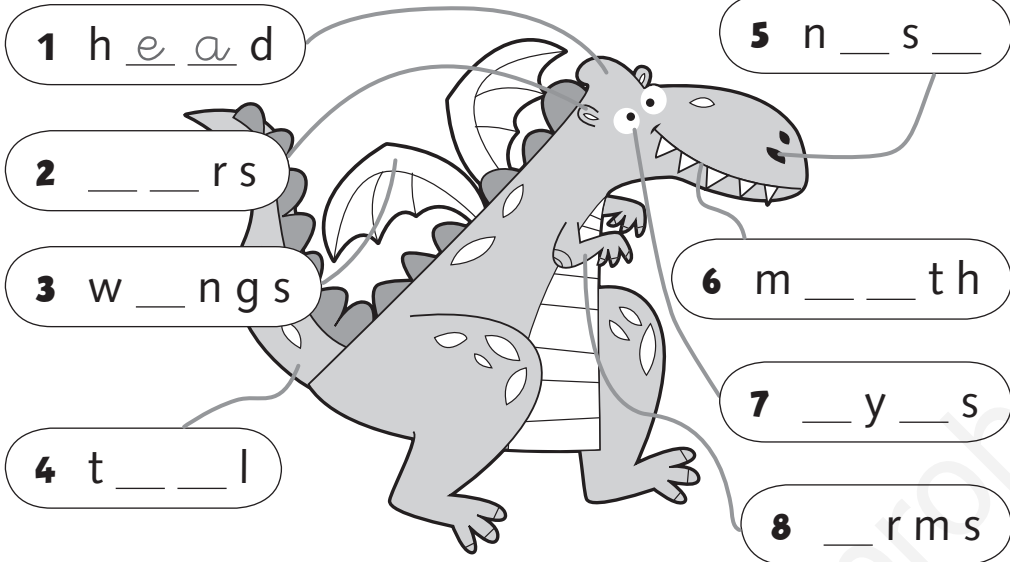

t	a	r	m	s	e
m	o	u	t	h	y
o	p	u	d	o	e
w	o	n	d	k	s
i	p	o	u	t	h
n	a	s	e	a	e
g	s	e	a	i	a
s	t	a	r	l	d
e	a	k	s	a	e

➔ Write. ➔ Read and number.

1
It's got a long tail.
It's got 2 .
It hasn't got .
It can c limb. It's a _____.

2
It's got 2 .
It's got .
It hasn't got .
It can f _____. It's a _____.

3
It's got long .
It's got a small .
It hasn't got .
It can r _____. It's a _____.

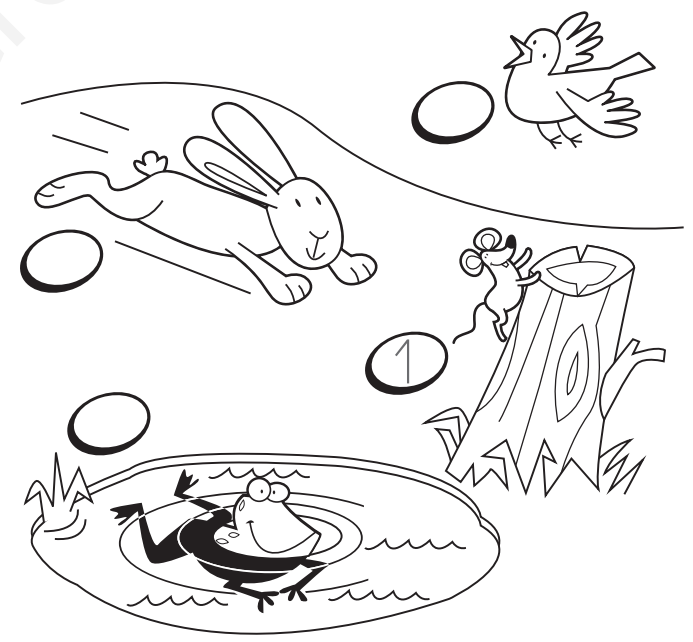

4
It's got 4 .
It's got big .
It hasn't got a .
It can s _____. It's a _____.

➔ Write.

➔ Match.

1 s i h
r t T-

T-shirt

2 r d e
s s

3 o e s
h s

4 t
a h

5 c k a
e t j

6 t r s o
e r s u

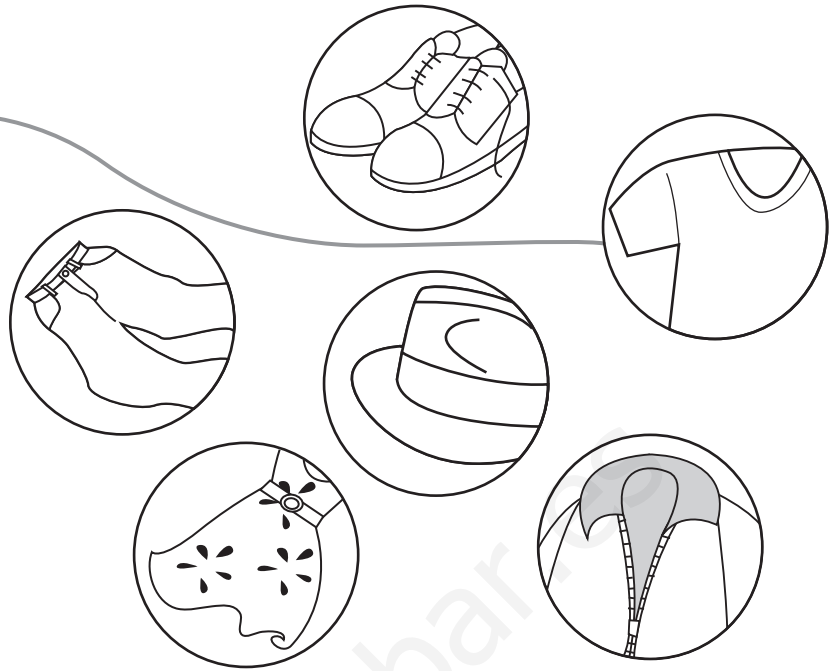

➔ Colour.

➔ Look and write.

1 = red 2 = blue 3 = yellow 4 = green

5 = orange 6 = pink 7 = brown 8 = black



a  I'm wearing a yellow dress and _____.

b  I'm wearing a _____ and _____.

c  I'm wearing a _____ and _____.

d  I'm wearing an _____ and a _____.

➔ Look and write.

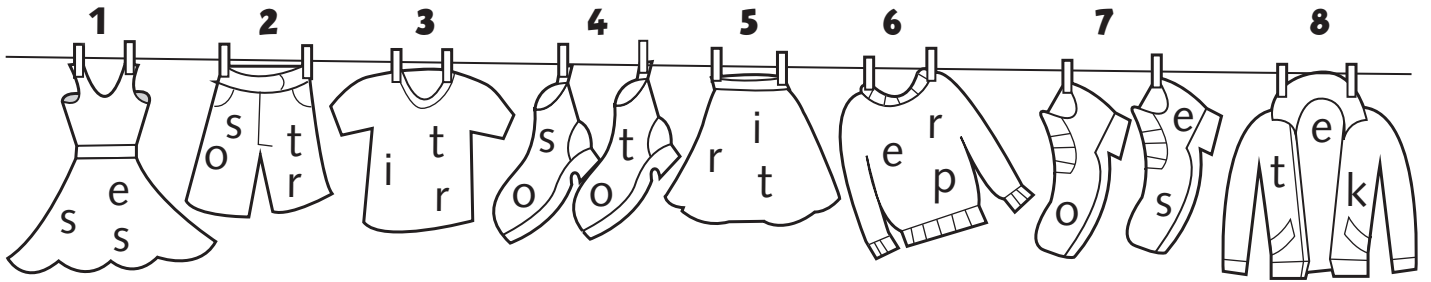



- 1 dress _____ 2 sh _____ 3 T-sh _____ 4 b _____
 5 sk _____ 6 jum _____ 7 sh _____ 8 jac _____

➔ Choose and colour. ➔ Look and write. ➔ Write and draw for you.

1  I'm wearing a yellow T-shirt
 and _____.
 I can _____.

2 I'm wearing a _____
 and _____.
 I can _____.



3  I'm wearing a _____
 and _____.
 I can _____.

4 I'm wearing _____.
 _____.
 I can _____.

