



ACTIVIDAD: **ABECEDARIO**

Nombre:

Fecha:

Repasa y escribe:

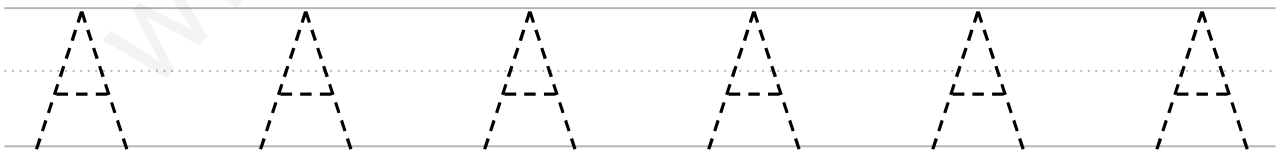
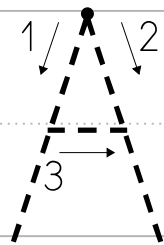
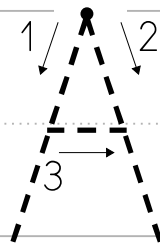
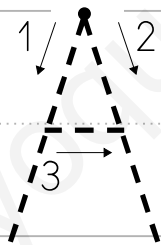
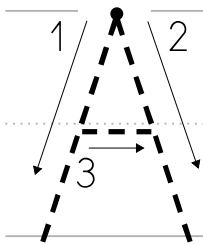
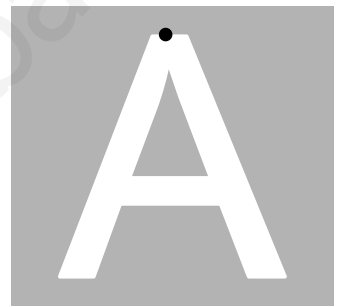
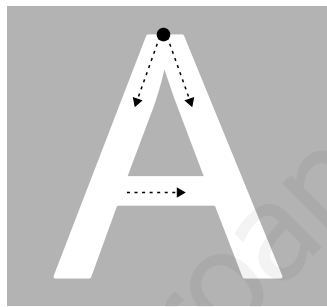
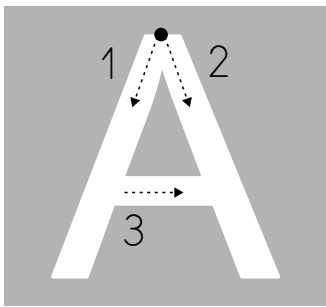
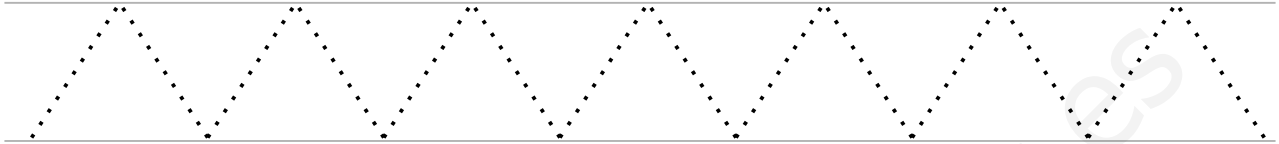



ACTIVIDAD: ABECEDARIO

Nombre:

Fecha:

Repasa y escribe:

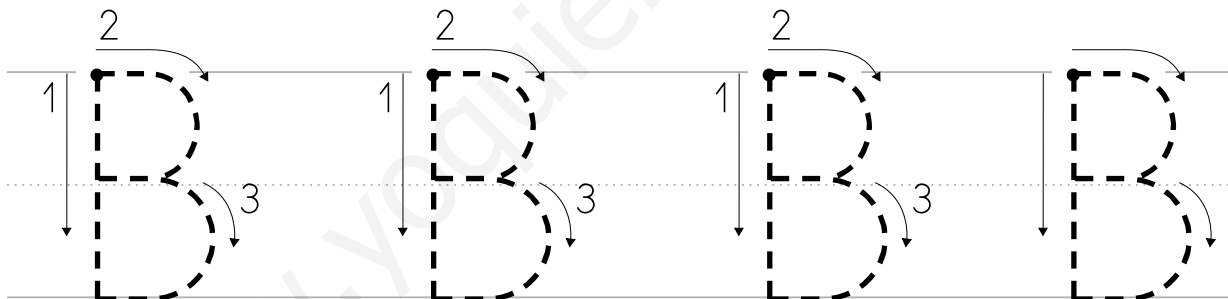
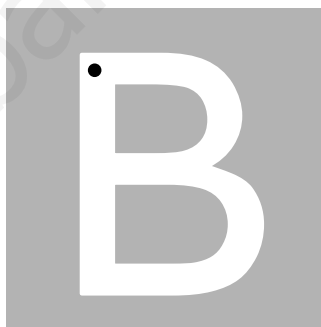
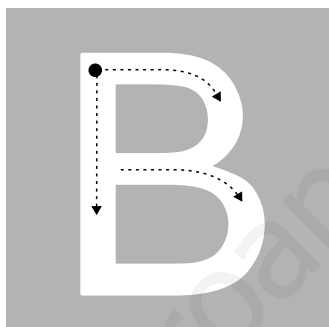
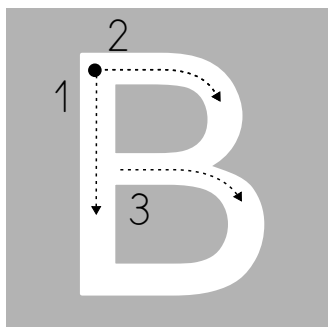
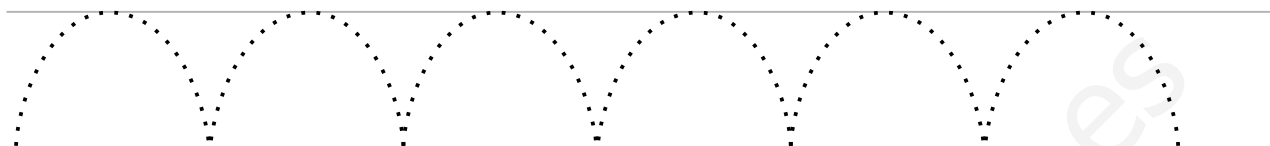

ACTIVIDAD: **ABECEDARIO**

Nombre:

Fecha:

Repasa y escribe:

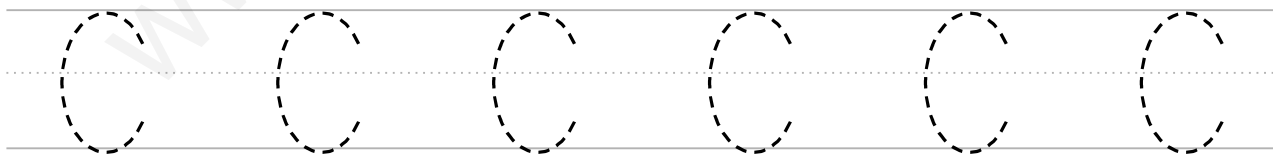
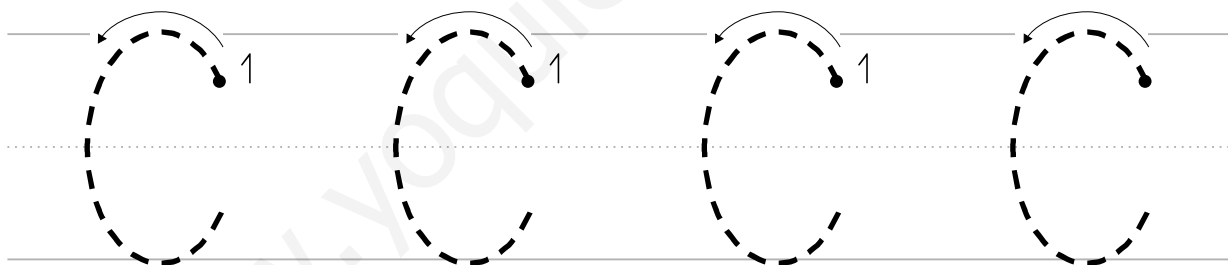
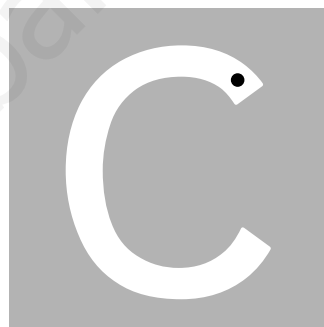
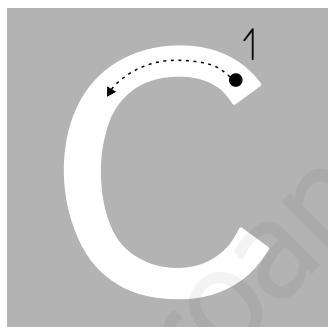
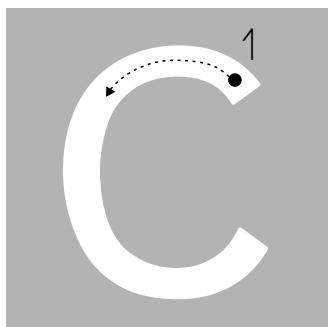
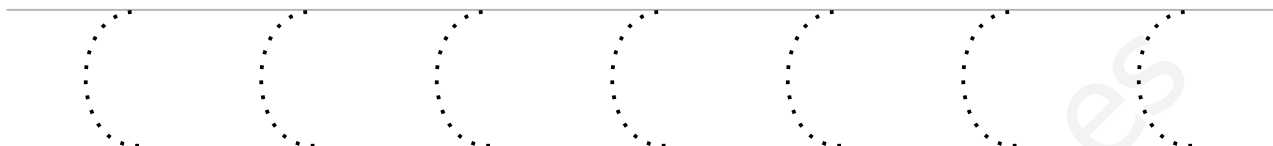

educaplanet
GRIN**ACTIVIDAD: ABECEDARIO**

Nombre:

Fecha:

Repasa y escribe:

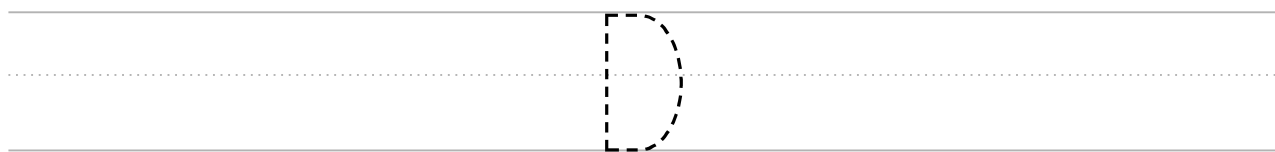
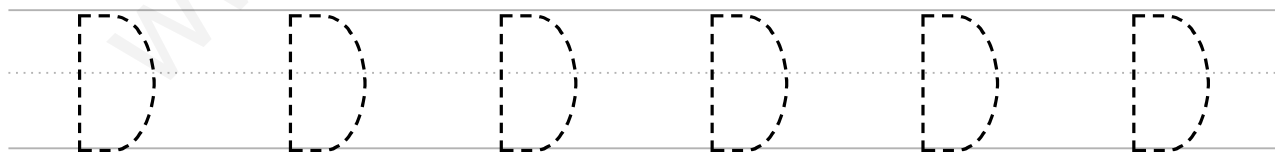
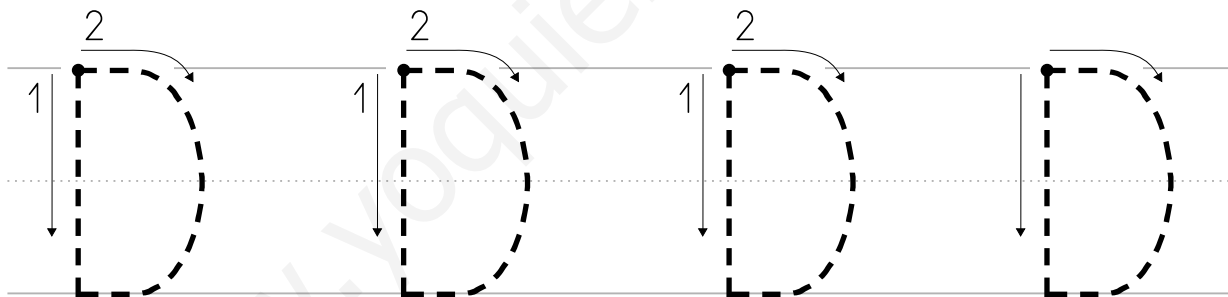
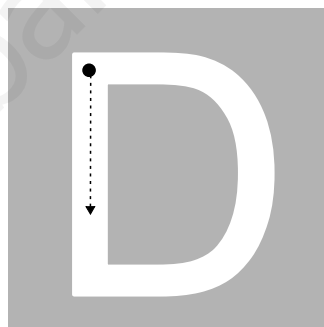
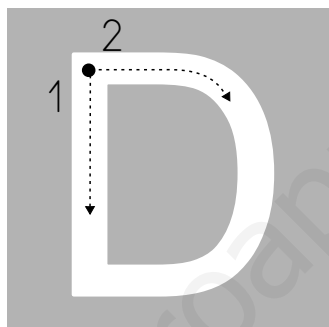
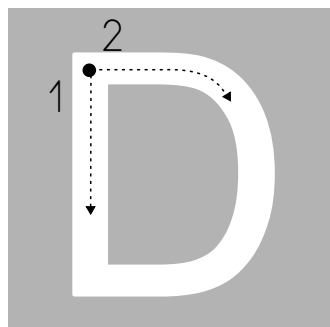
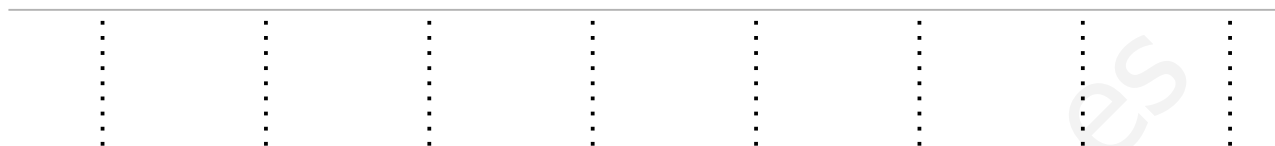

ACTIVIDAD: ABECEDARIO

Nombre:

Fecha:



Repasa y escribe:

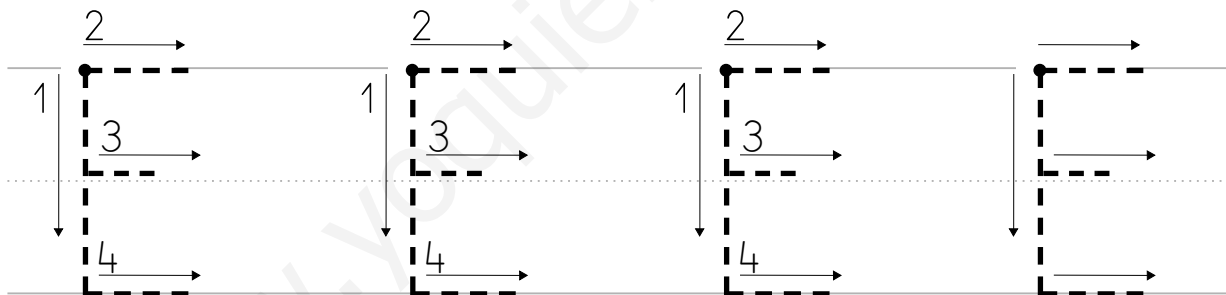
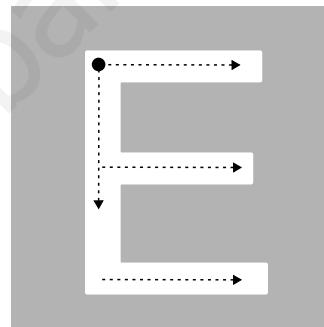
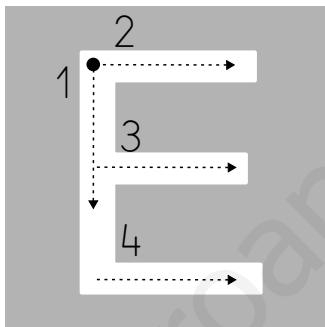
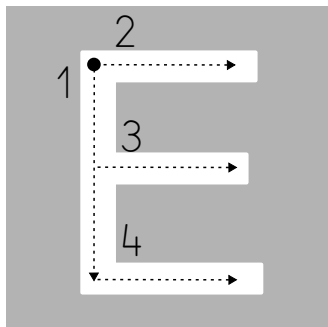
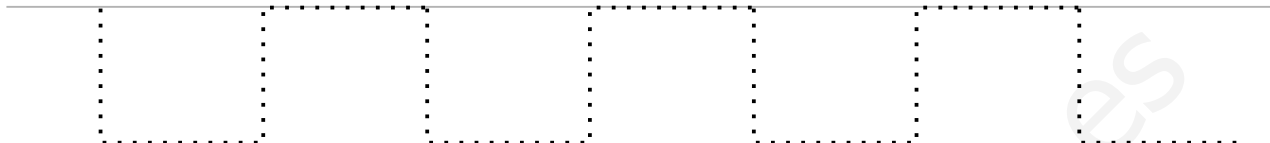

Nombre:

Fecha:



Repasa y escribe:

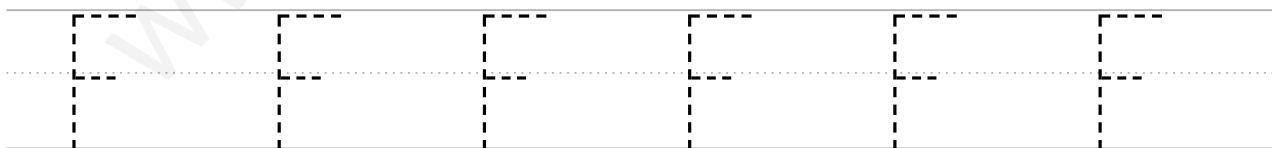
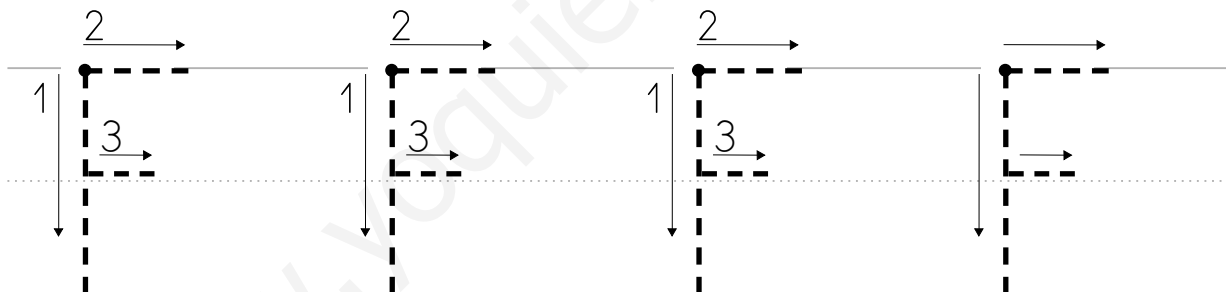
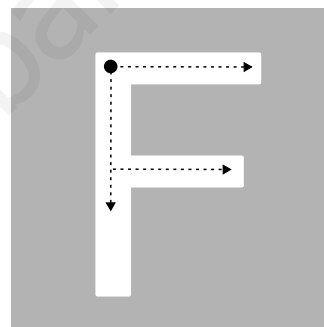
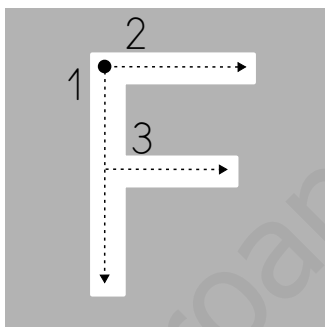
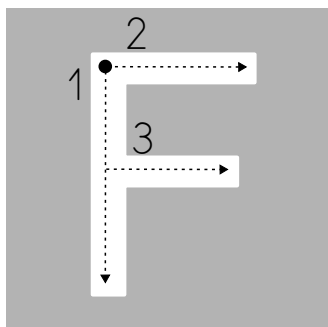
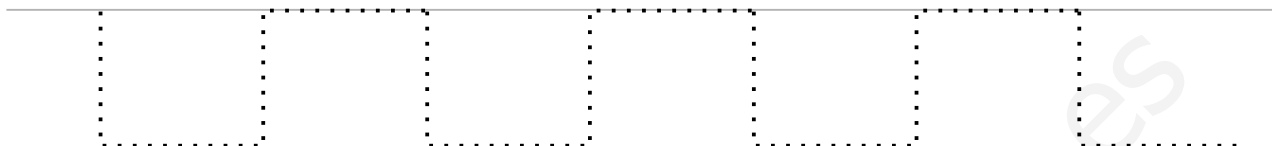



ACTIVIDAD: **ABECEDARIO**

Nombre:

Fecha:

Repasa y escribe:

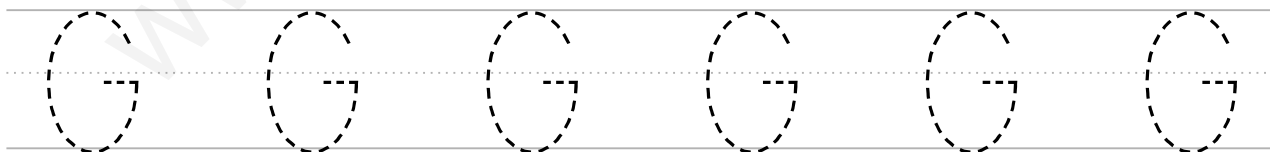
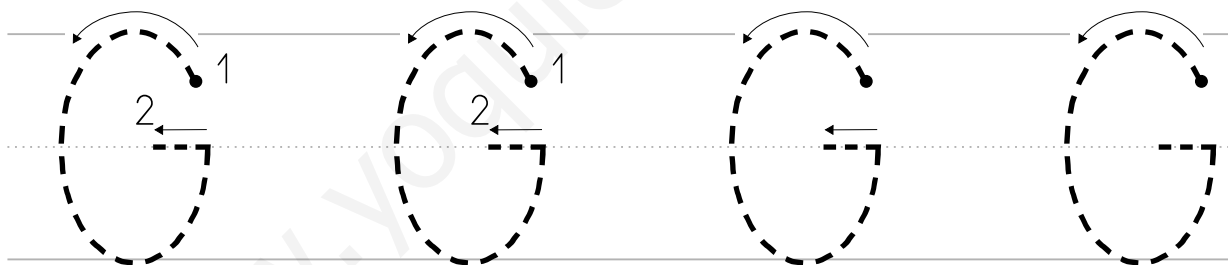
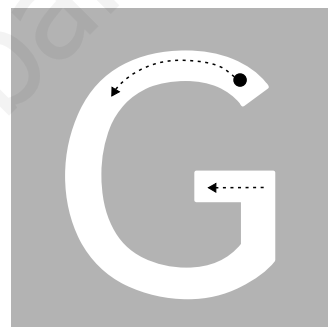
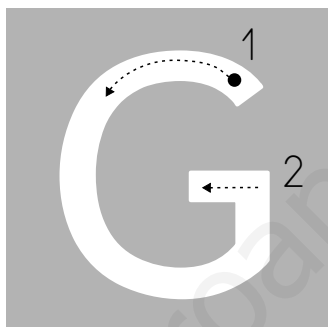
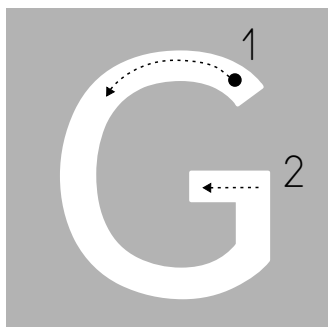
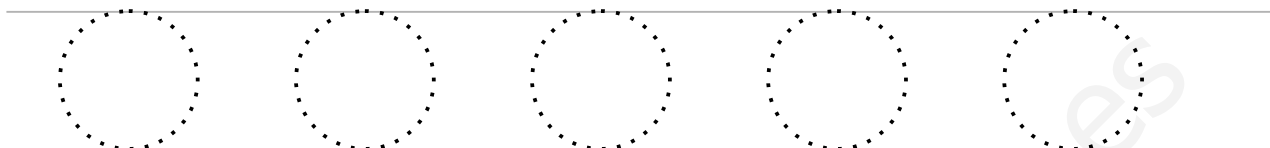

ACTIVIDAD: **ABECEDARIO**

Nombre:

Fecha:

Repasa y escribe:

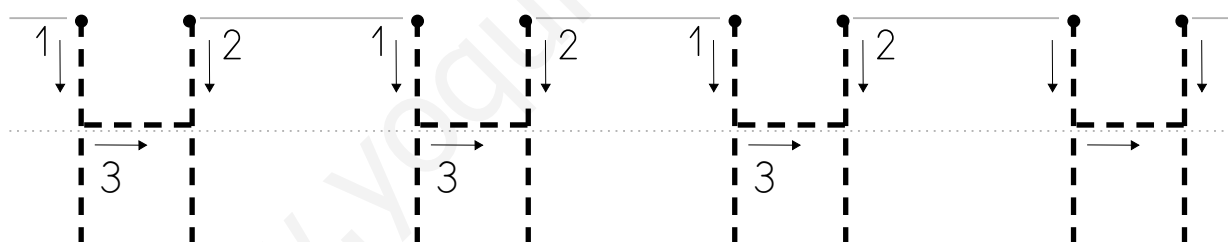
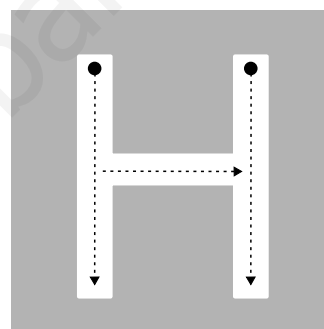
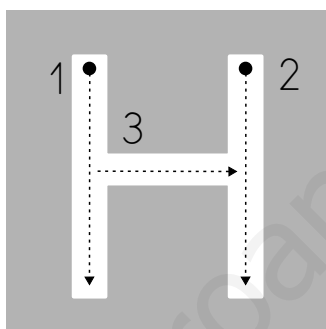
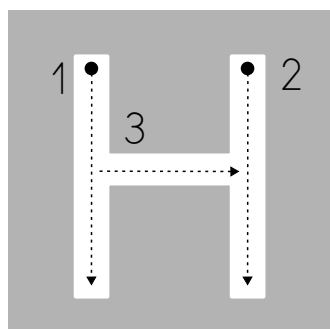
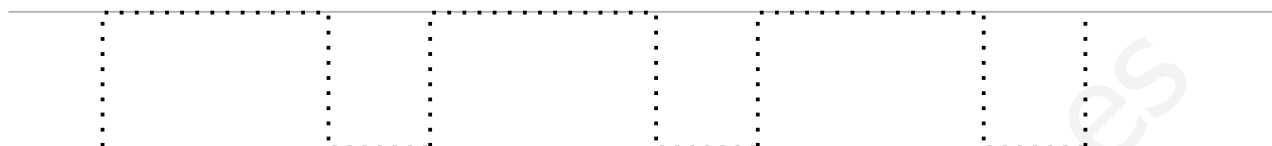

ACTIVIDAD: **ABECEDARIO**

Nombre:

Fecha:



Repasa y escribe:

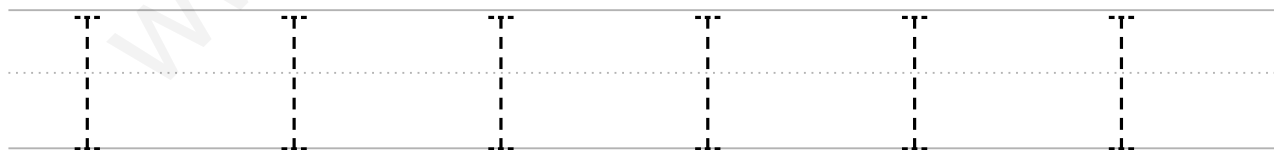
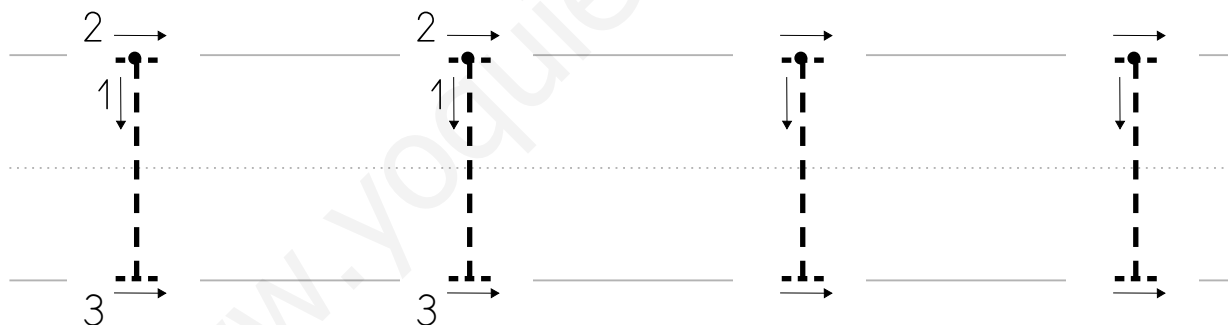
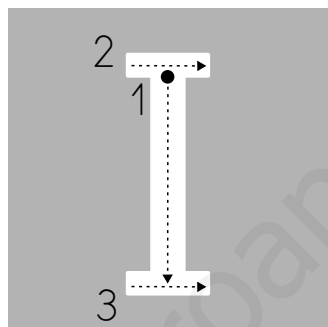
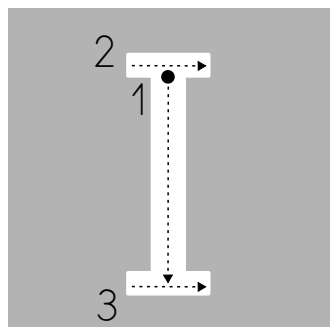
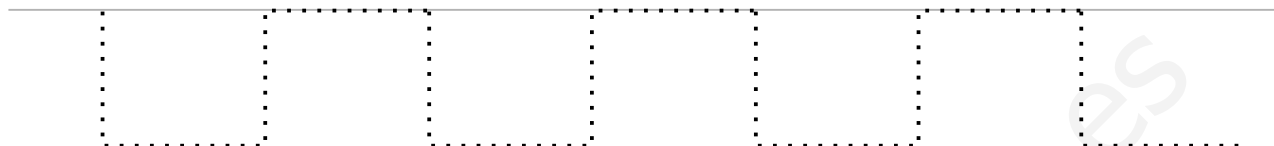



ACTIVIDAD: ABECEDARIO

Nombre:

Fecha:

Repasa y escribe:

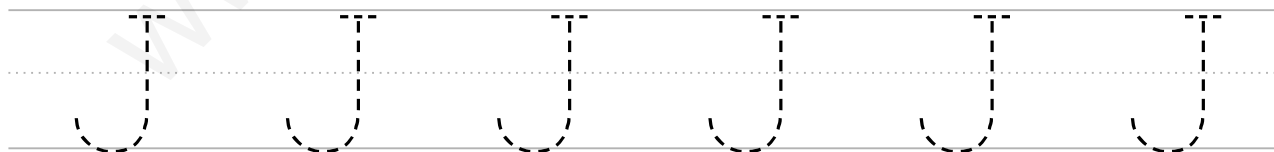
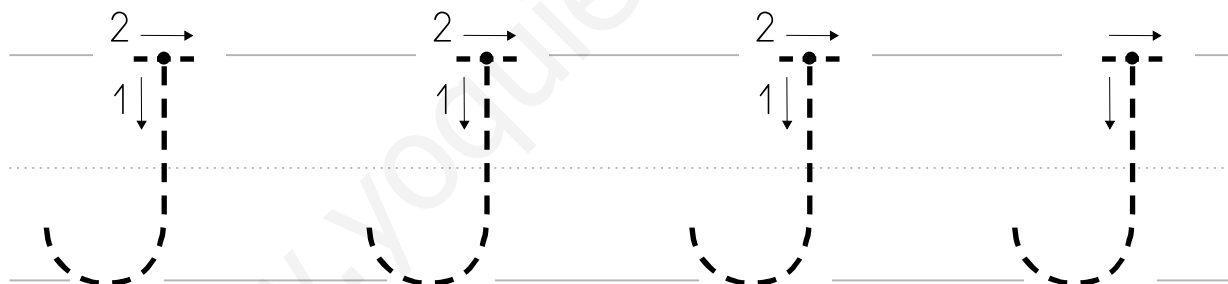
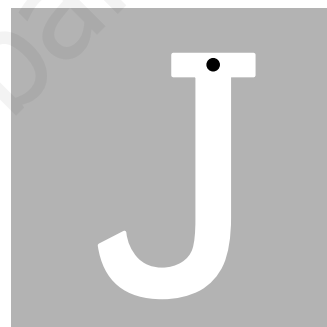
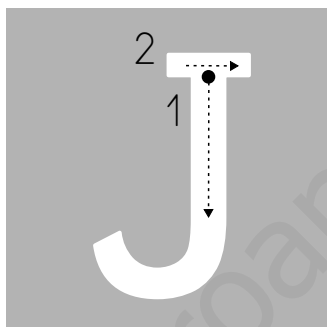
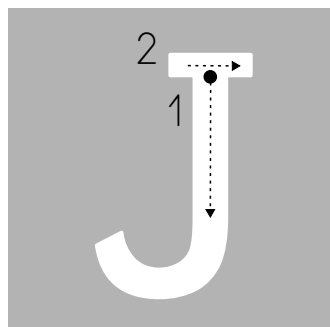
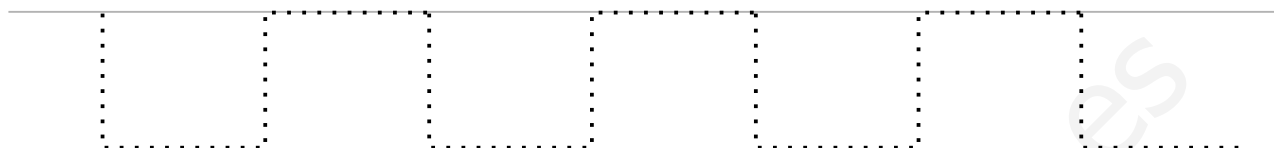

Nombre:

Fecha:



Repasa y escribe:

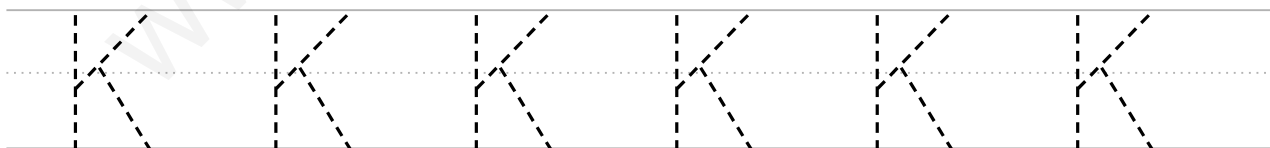
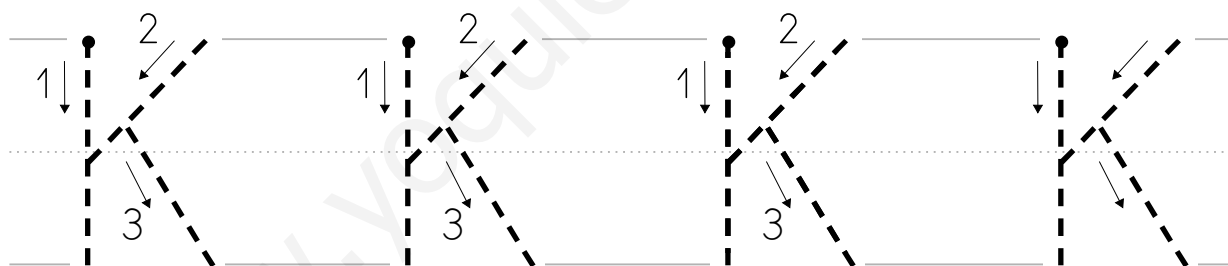
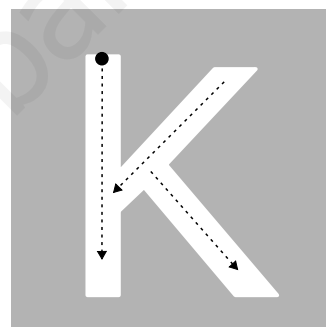
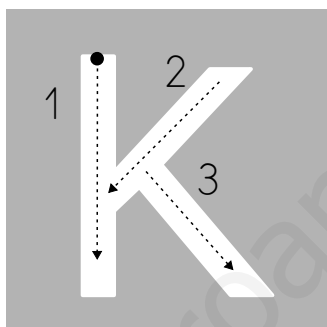
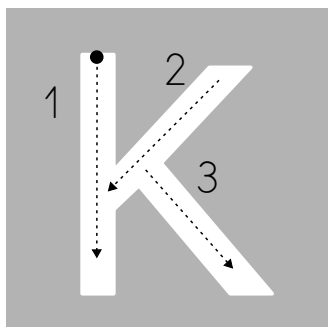
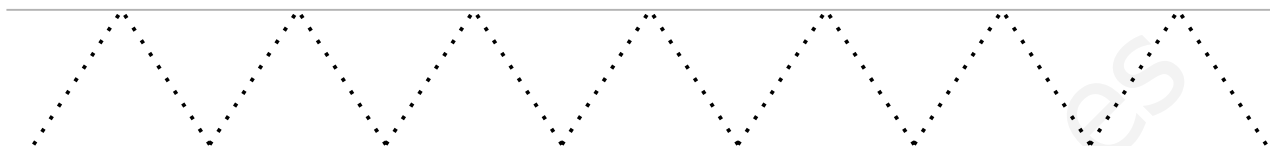

ACTIVIDAD: **ABECEDARIO**

Nombre:

Fecha:

Repasa y escribe:

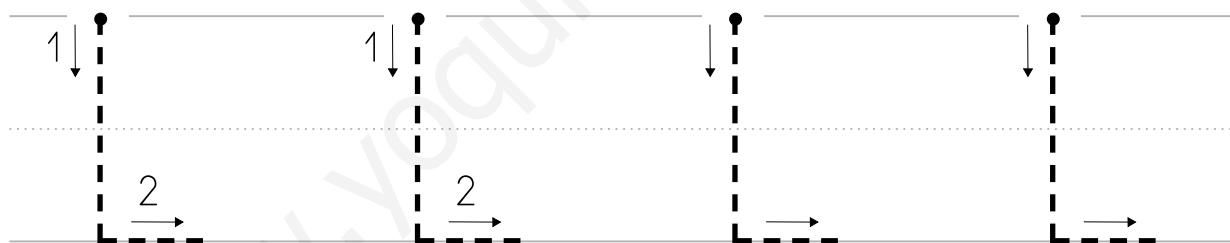
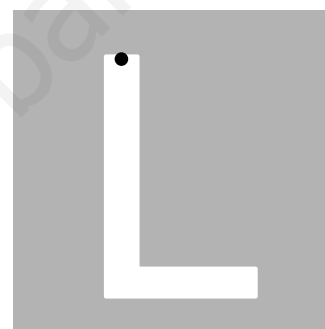
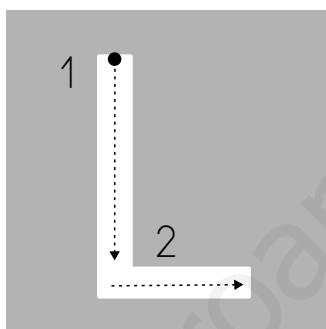
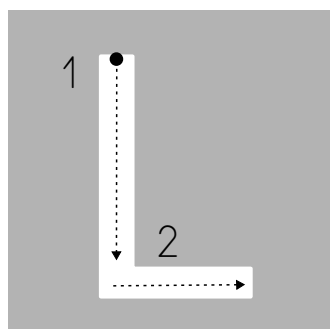
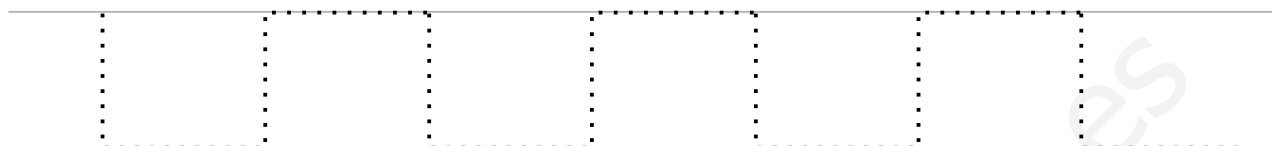

ACTIVIDAD: **ABECEDARIO**

Nombre:

Fecha:

Repasa y escribe:

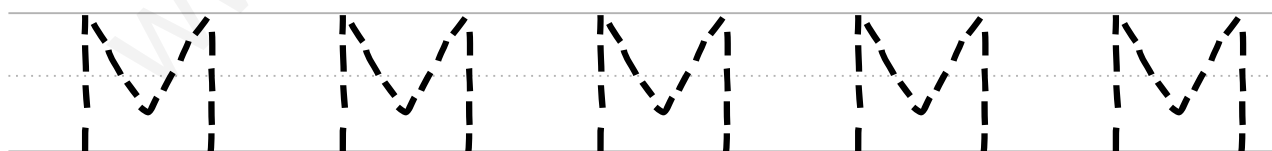
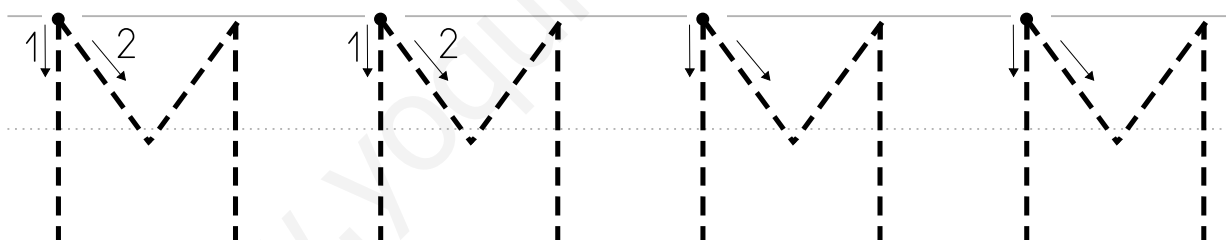
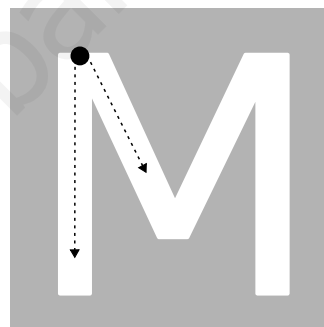
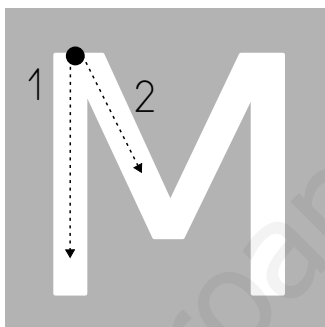
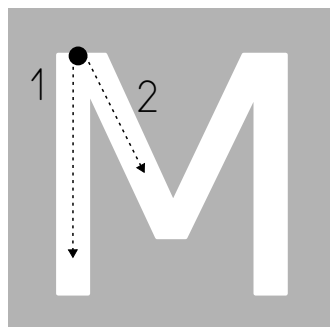
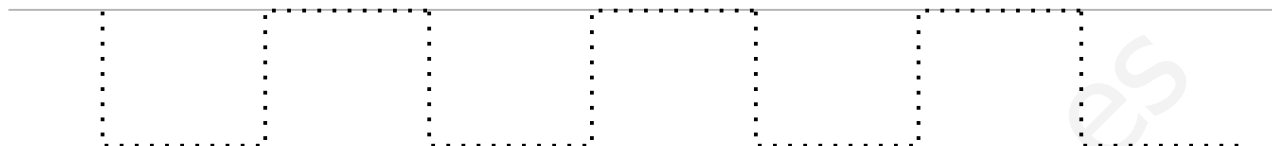

ACTIVIDAD: **ABECEDARIO**

Nombre:

Fecha:



Repasa y escribe:

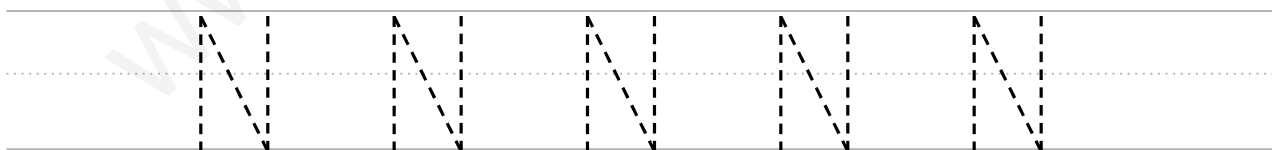
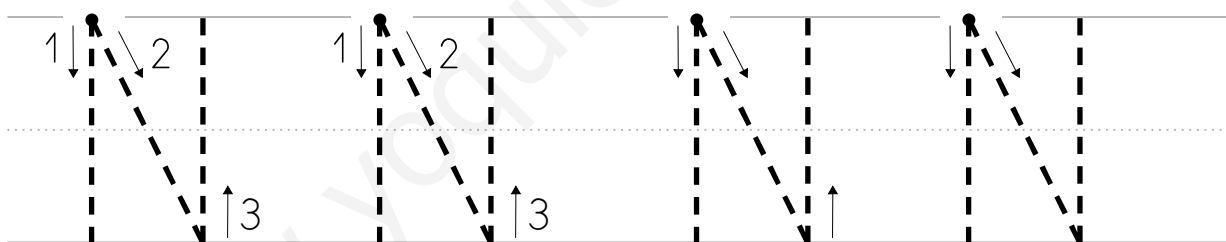
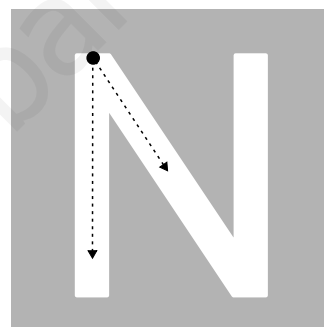
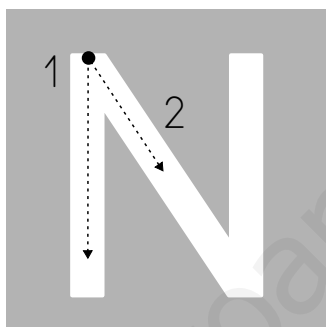
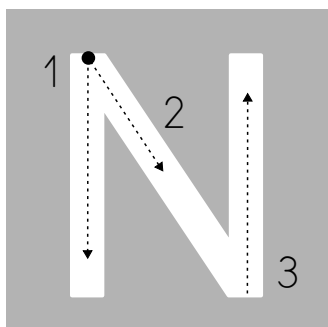
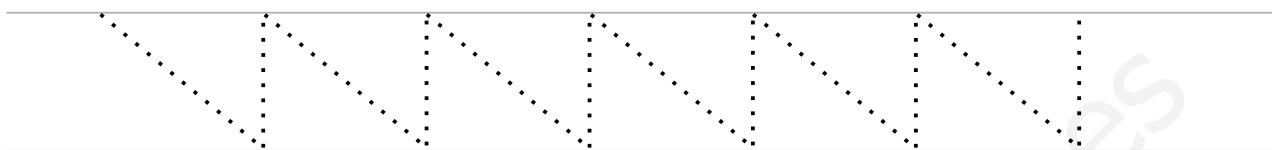



ACTIVIDAD: ABECEDARIO

Nombre:

Fecha:

Repasa y escribe:

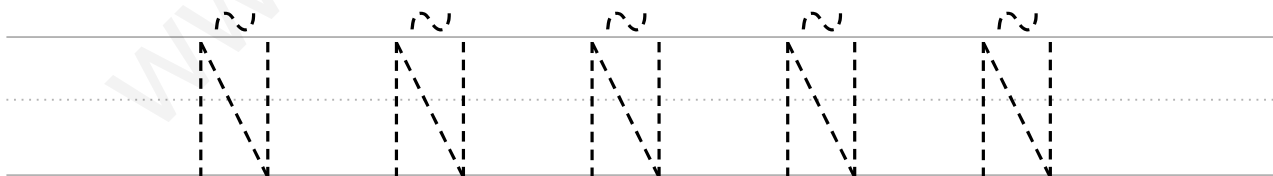
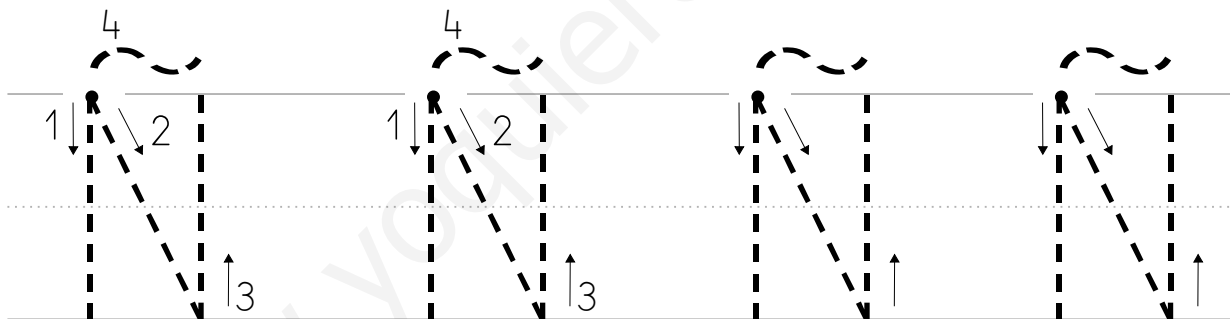
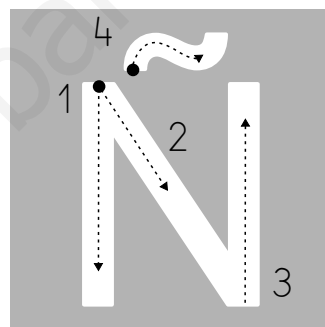
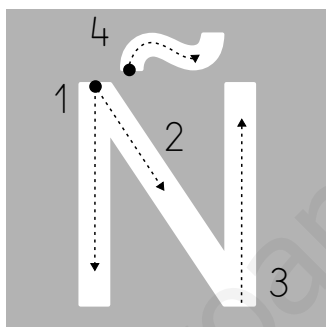
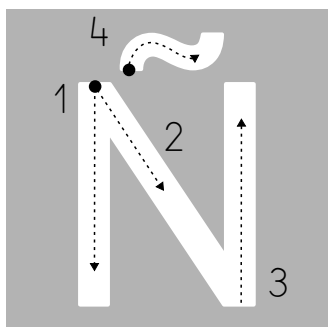
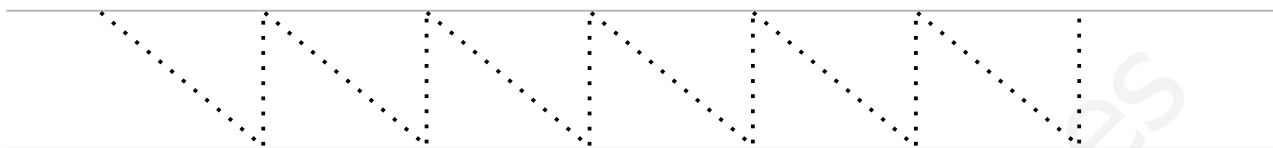

**ACTIVIDAD: ABECEDARIO**

Nombre:

Fecha:

Repasa y escribe:

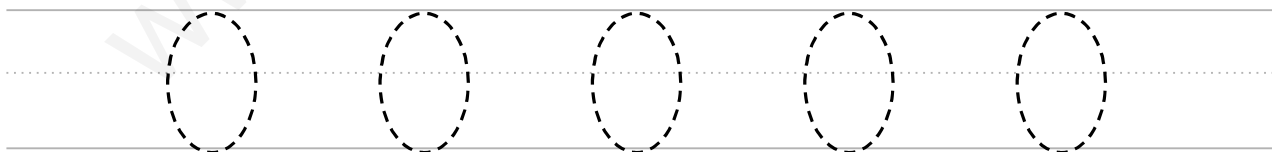
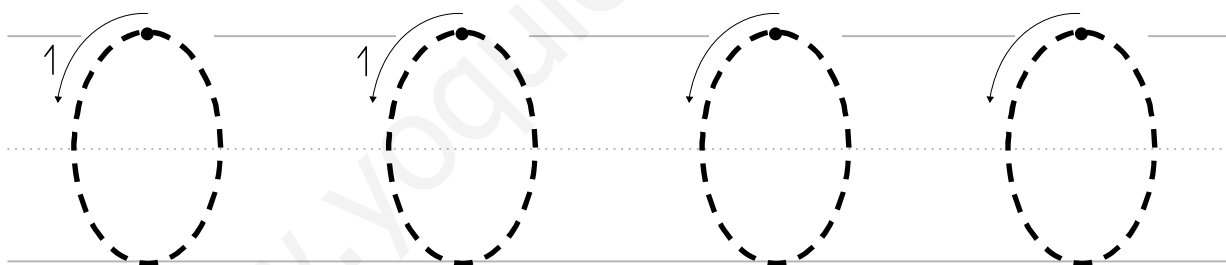
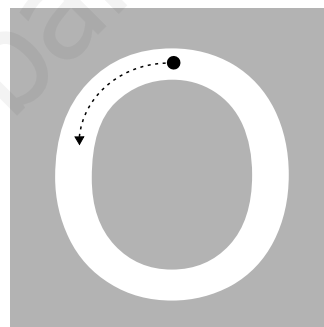
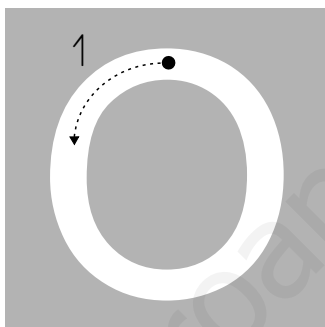
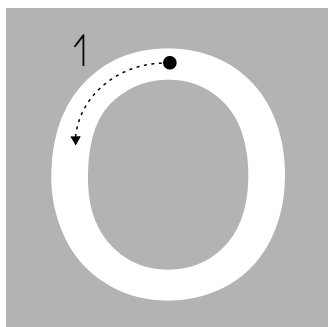
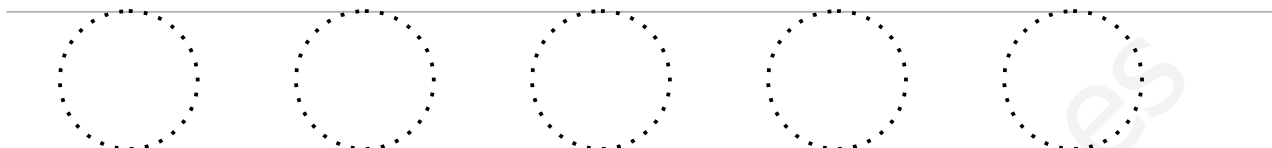



ACTIVIDAD: ABECEDARIO

Nombre:

Fecha:

Repasa y escribe:

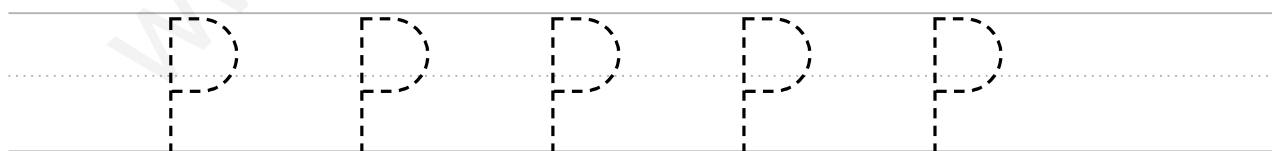
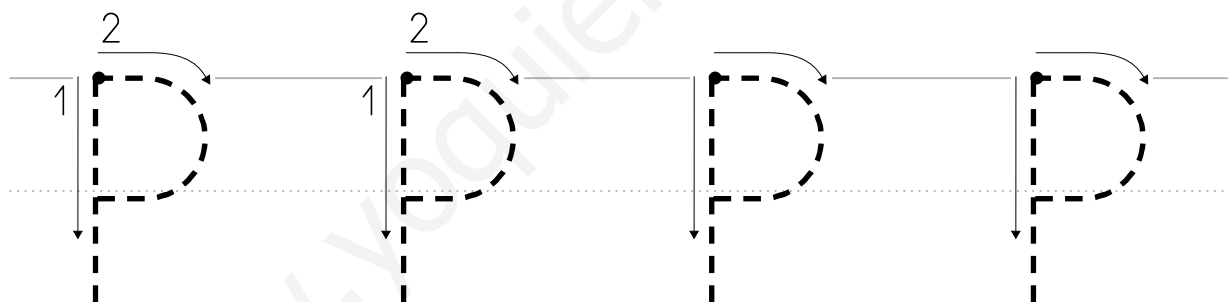
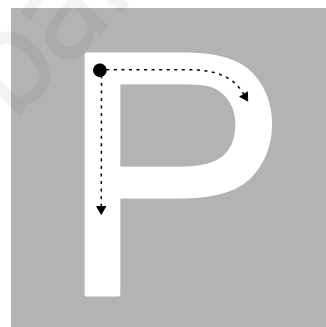
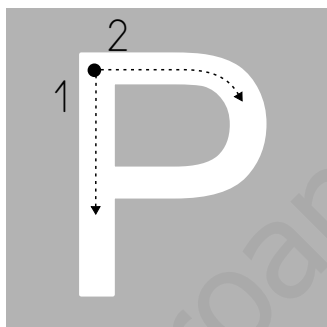
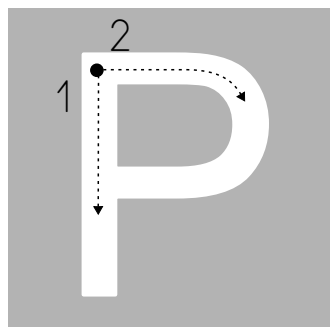
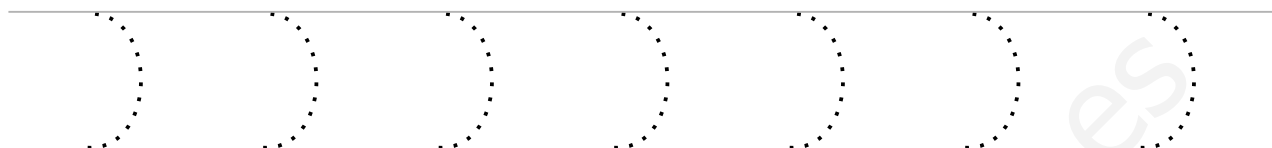

ACTIVIDAD: **ABECEDARIO**

Nombre:

Fecha:

Repasa y escribe:

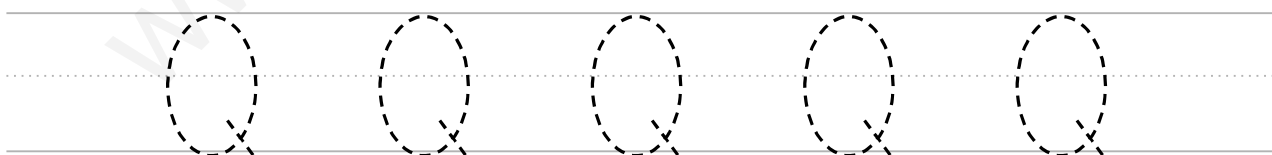
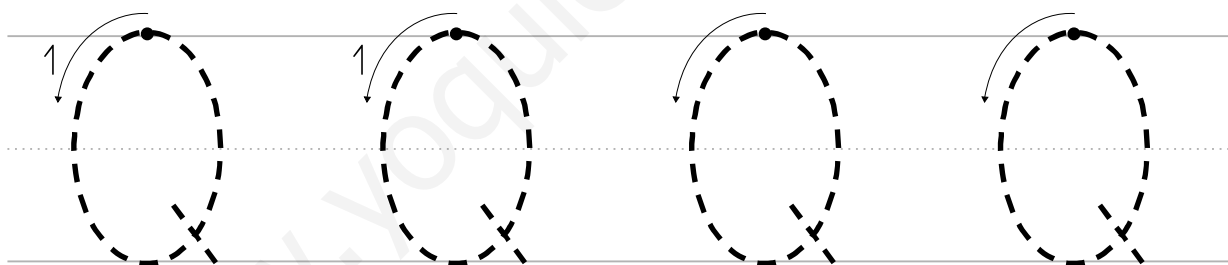
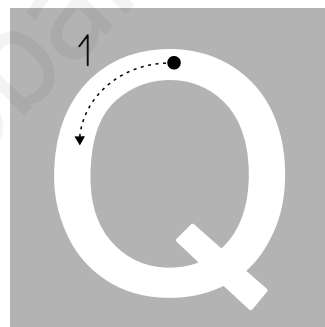
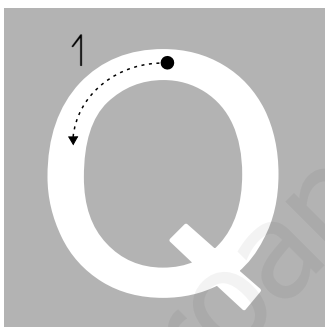
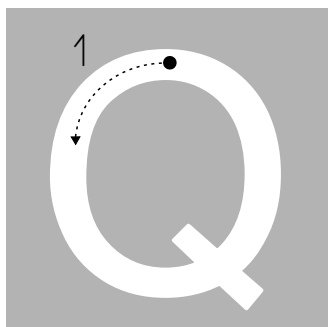



ACTIVIDAD: ABECEDARIO

Nombre:

Fecha:

Repasa y escribe:

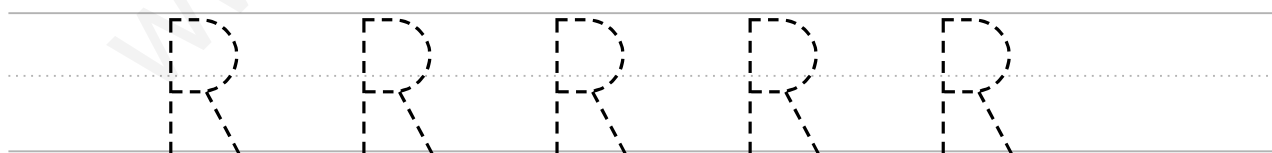
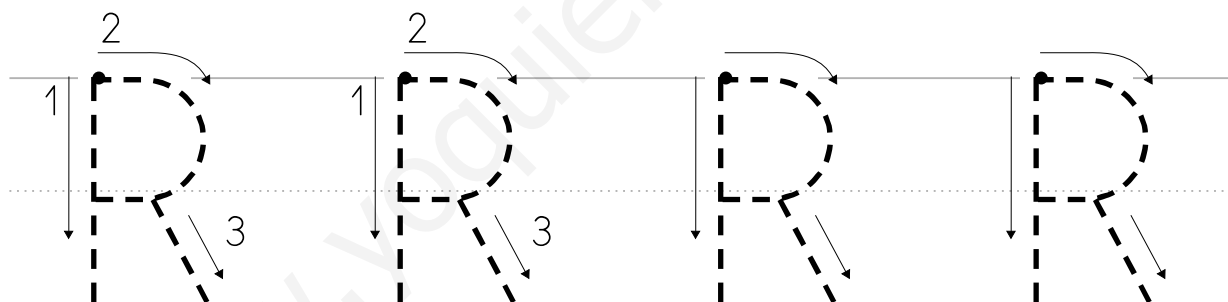
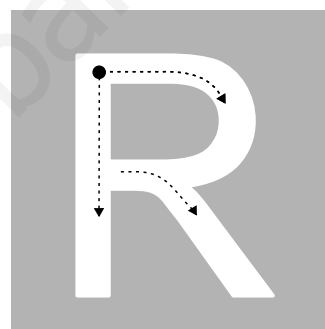
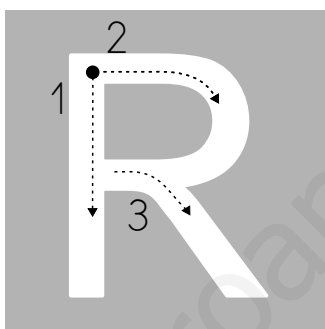
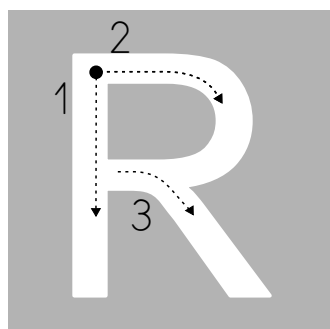
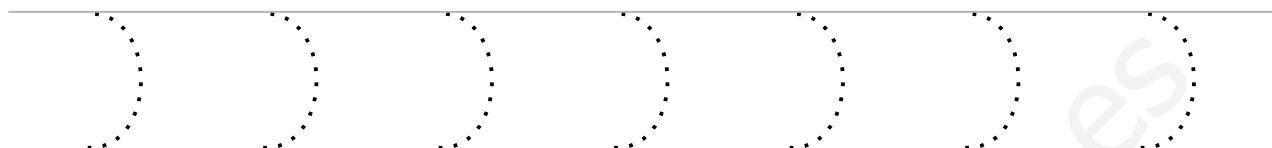

**ACTIVIDAD: ABECEDARIO**

Nombre:

Fecha:

Repasa y escribe:

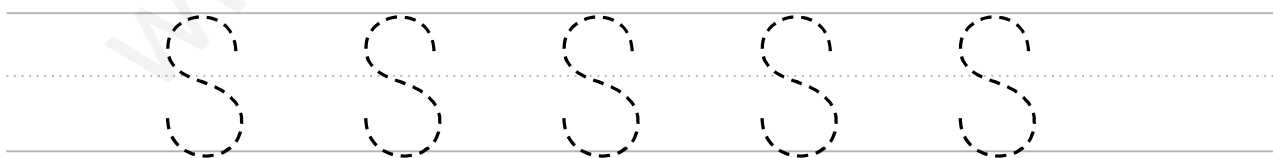
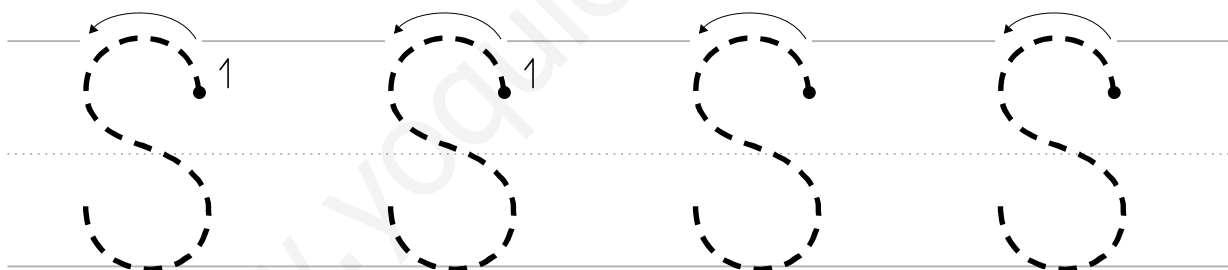
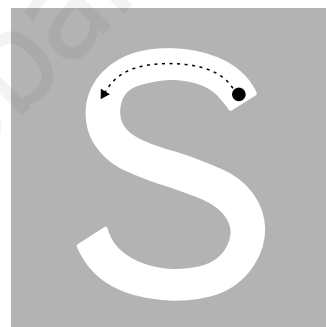
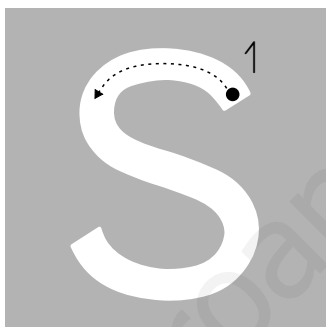
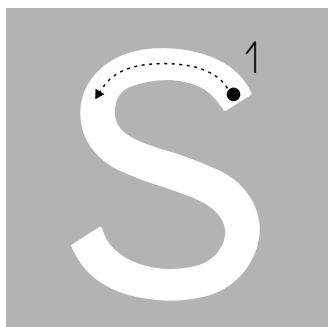
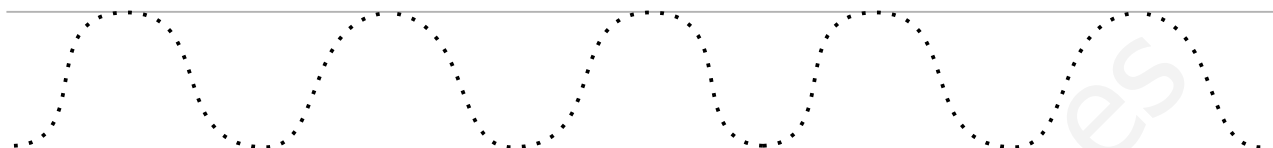

ACTIVIDAD: **ABECEDARIO**

Nombre:

Fecha:

Repasa y escribe:

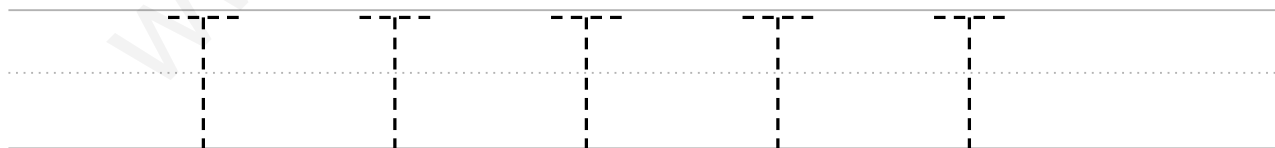
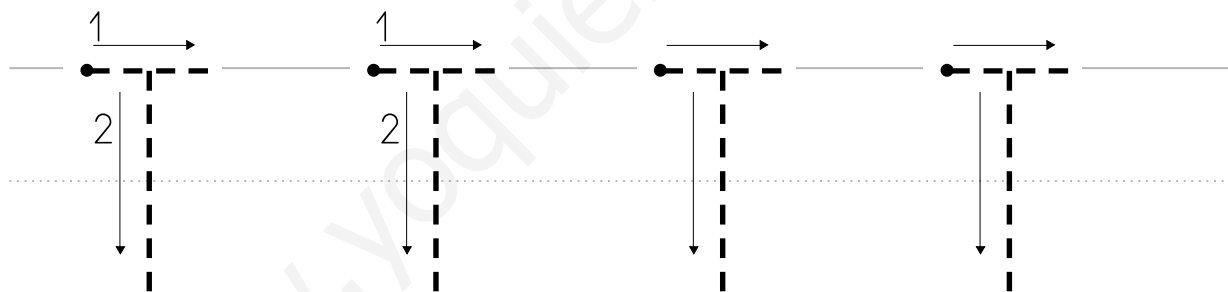
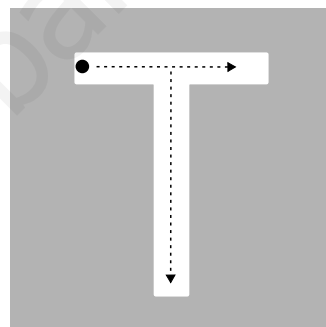
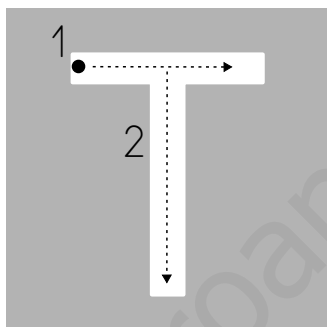
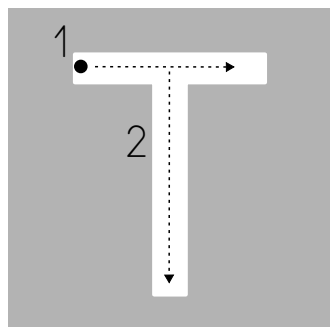
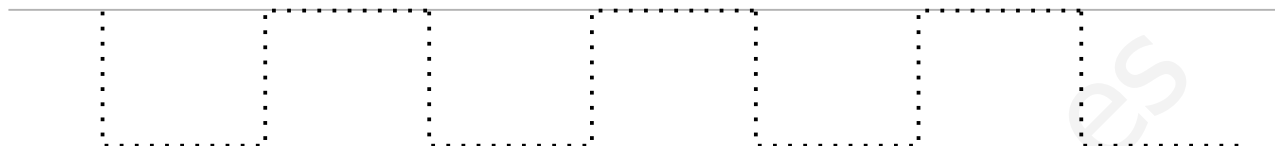

**ACTIVIDAD: ABECEDARIO**

Nombre:

Fecha:

Repasa y escribe:

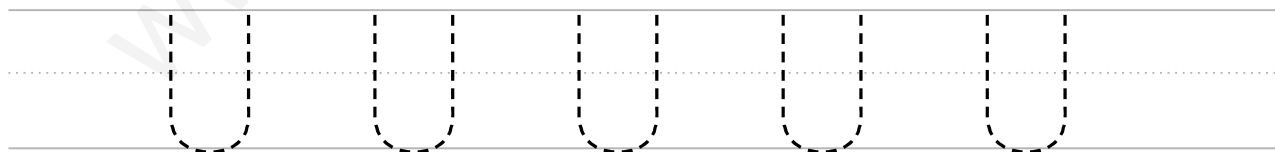
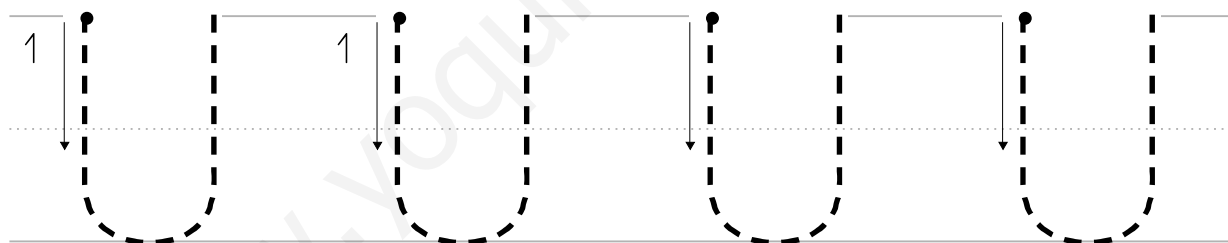
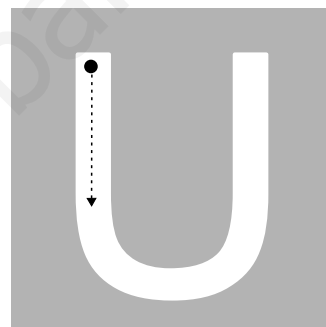
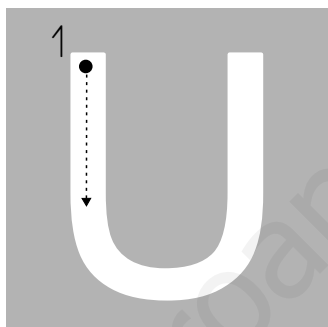
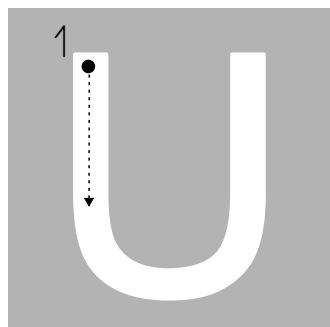
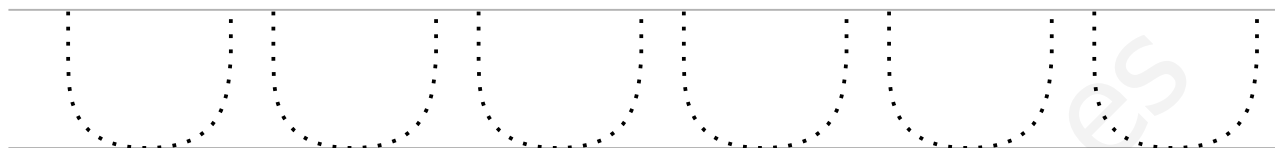

**ACTIVIDAD: ABECEDARIO**

Nombre:

Fecha:

Repasa y escribe:

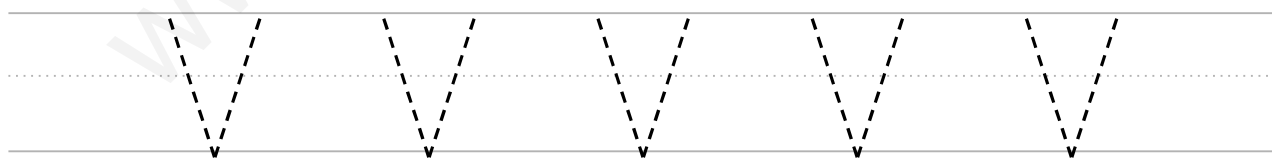
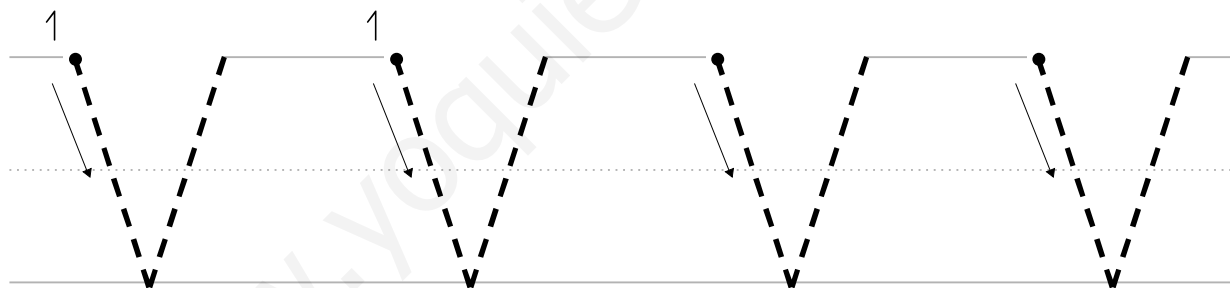
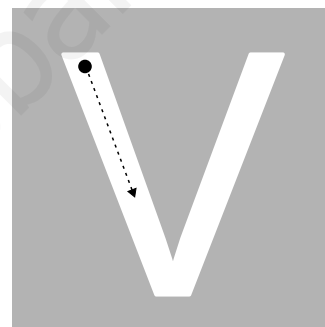
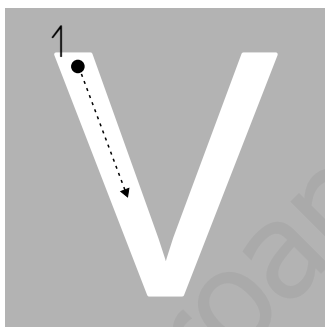
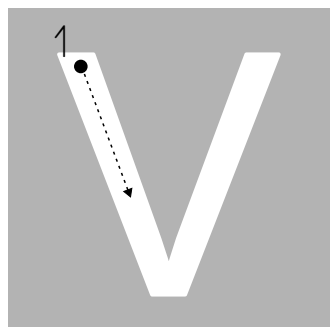



ACTIVIDAD: ABECEDARIO

Nombre:

Fecha:

Repasa y escribe:

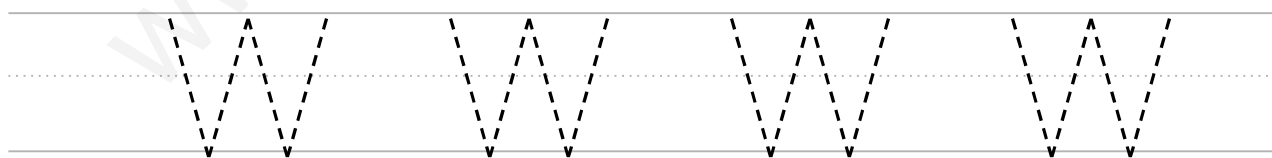
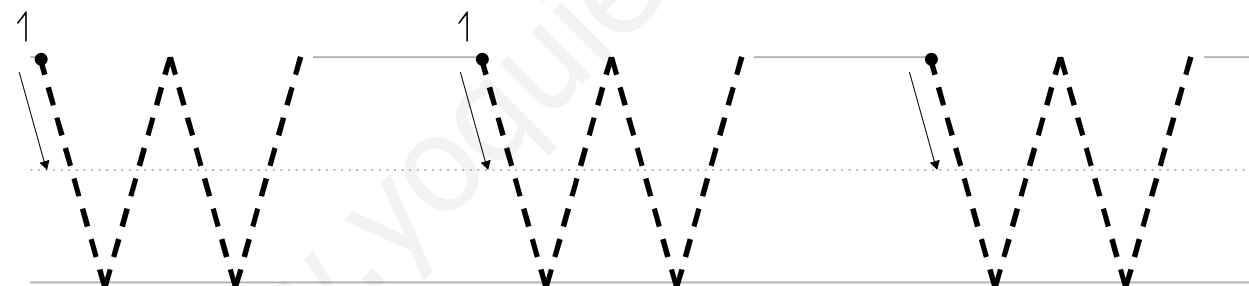
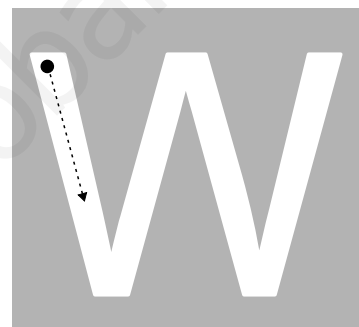
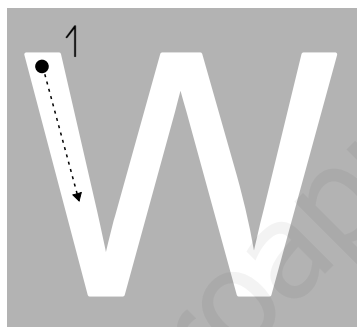
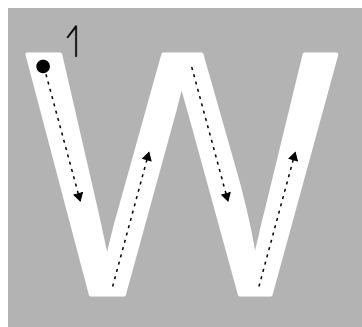



ACTIVIDAD: ABECEDARIO

Nombre:

Fecha:

Repasa y escribe:

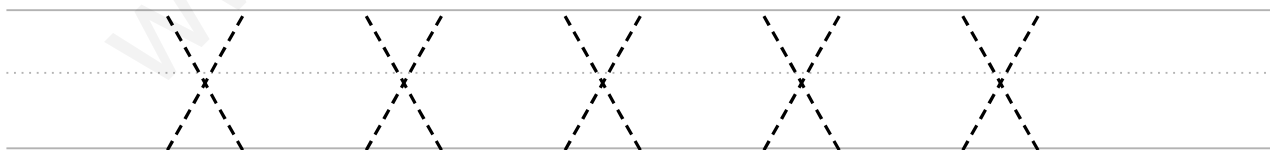
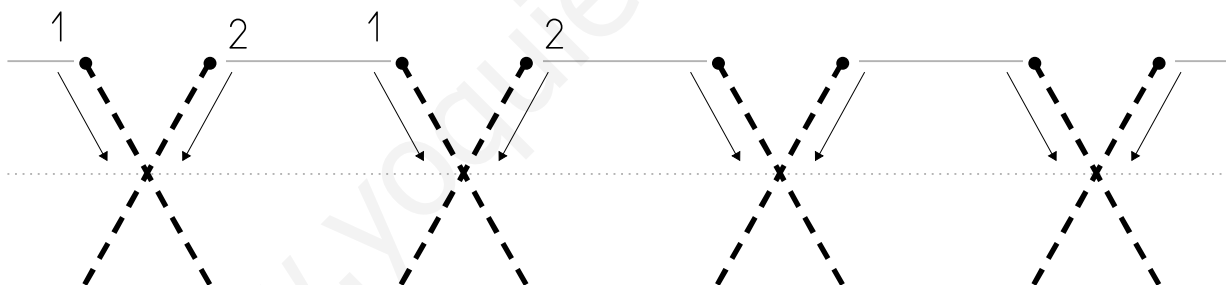
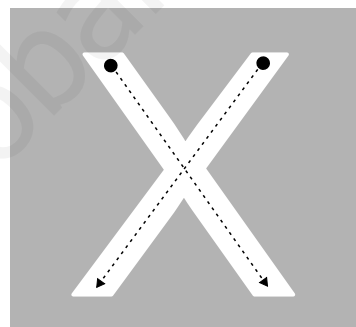
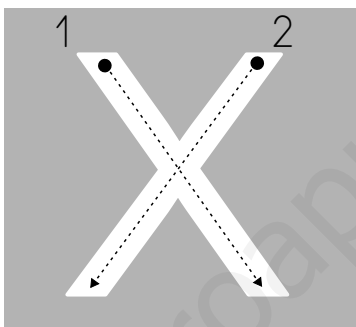
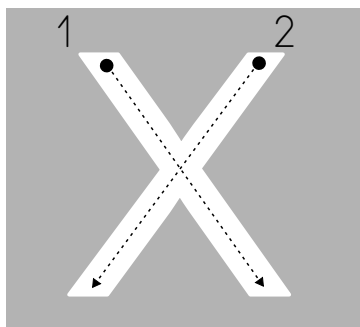

ACTIVIDAD: **ABECEDARIO**

Nombre:

Fecha:

Repasa y escribe:

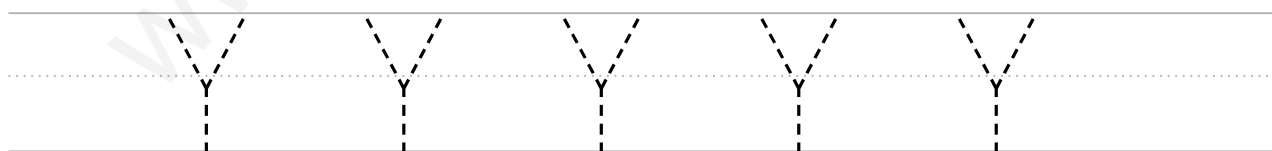
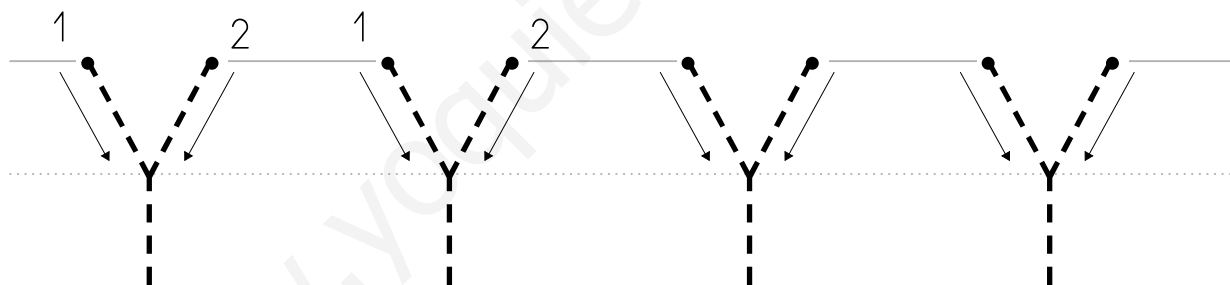
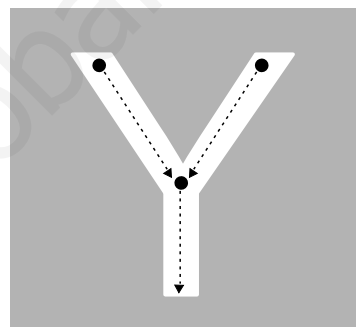
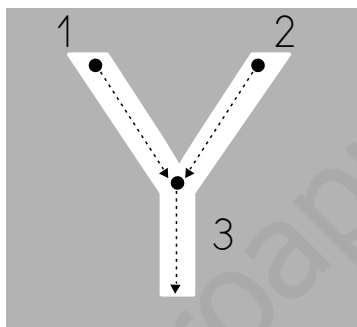
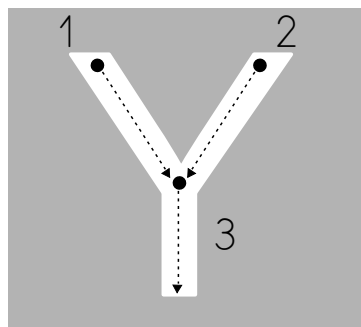
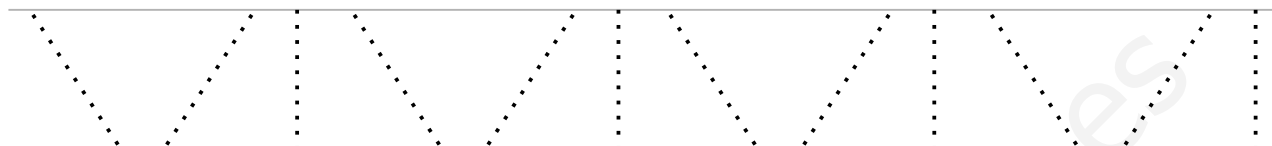

ACTIVIDAD: **ABECEDARIO**

Nombre:

Fecha:

Repasa y escribe:

