

DESARROLLO DE CUERPOS GEOMÉTRICOS

- **POLIEDROS**
 - **TETRAEDRO** 2
 - **HEXAEDRO O CUBO** 3
 - **OCTAEDRO** 4
 - **DODECAEDRO** 5
 - **ICOSAEDRO** 6

- **PRISMA**
 - **PRISMA TRIANGULAR** 7
 - **PRISMA CUADRANGULAR** 8
 - **PRISMA PENTAGONAL** 9
 - **PRISMA HEXAGONAL** 10

- **PIRÁMIDE**
 - **PIRÁMIDE TRIANGULAR** 11
 - **PIRÁMIDE CUADRANGULAR** 12
 - **PIRÁMIDE PENTAGONAL** 13
 - **PIRÁMIDE HEXAGONAL** 14
 - **PIRÁMIDE OCTAGONAL** 15
 - **PIRÁMIDE CUADRANGULAR TRUNCADA** 16

- **CILINDRO** 17

- **CONOS**
 - **CONO TRUNCADO** 18
 - **CONO TRUNCADO** 19

TETRAEDRO

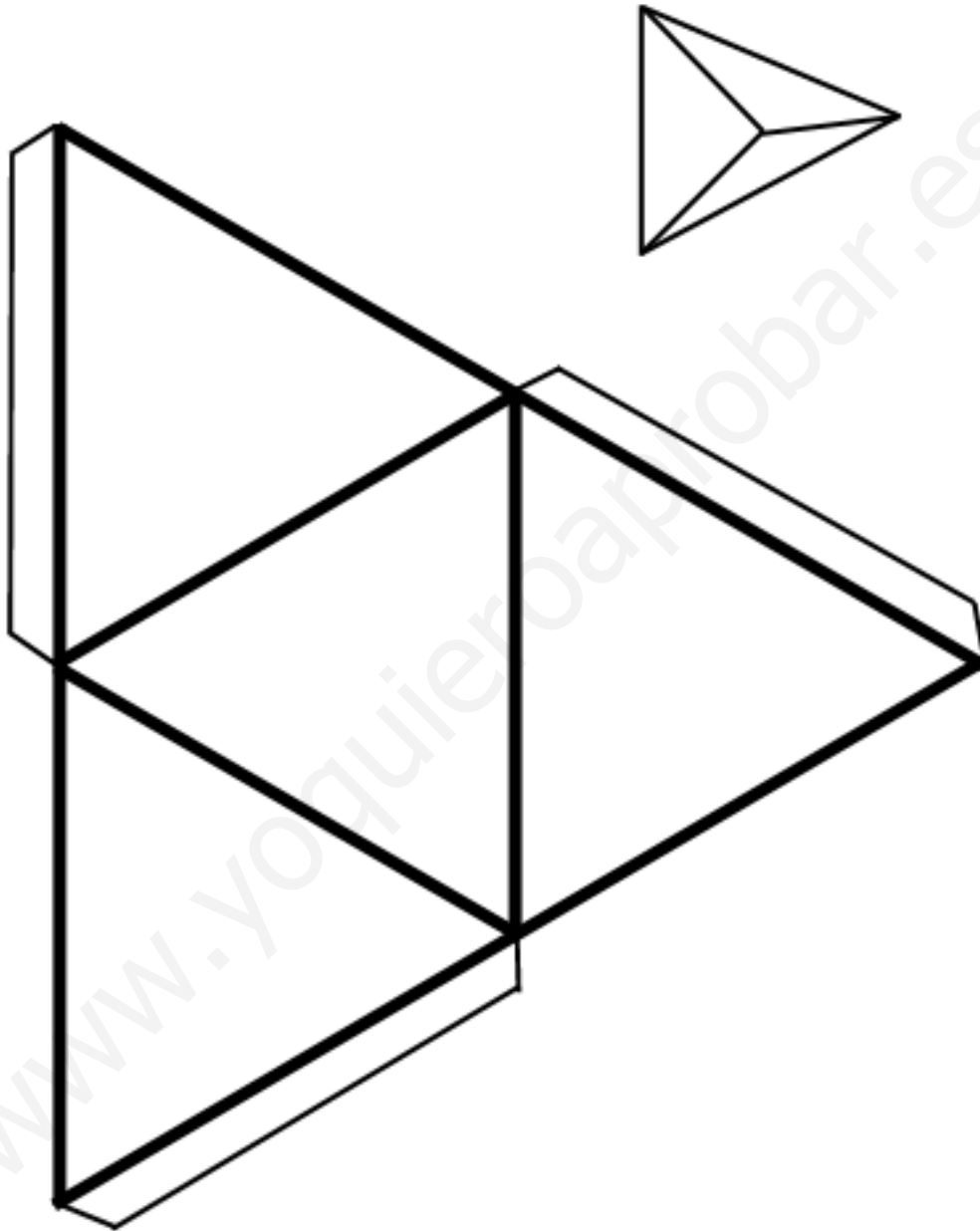

HEXAEDRO O CUBO

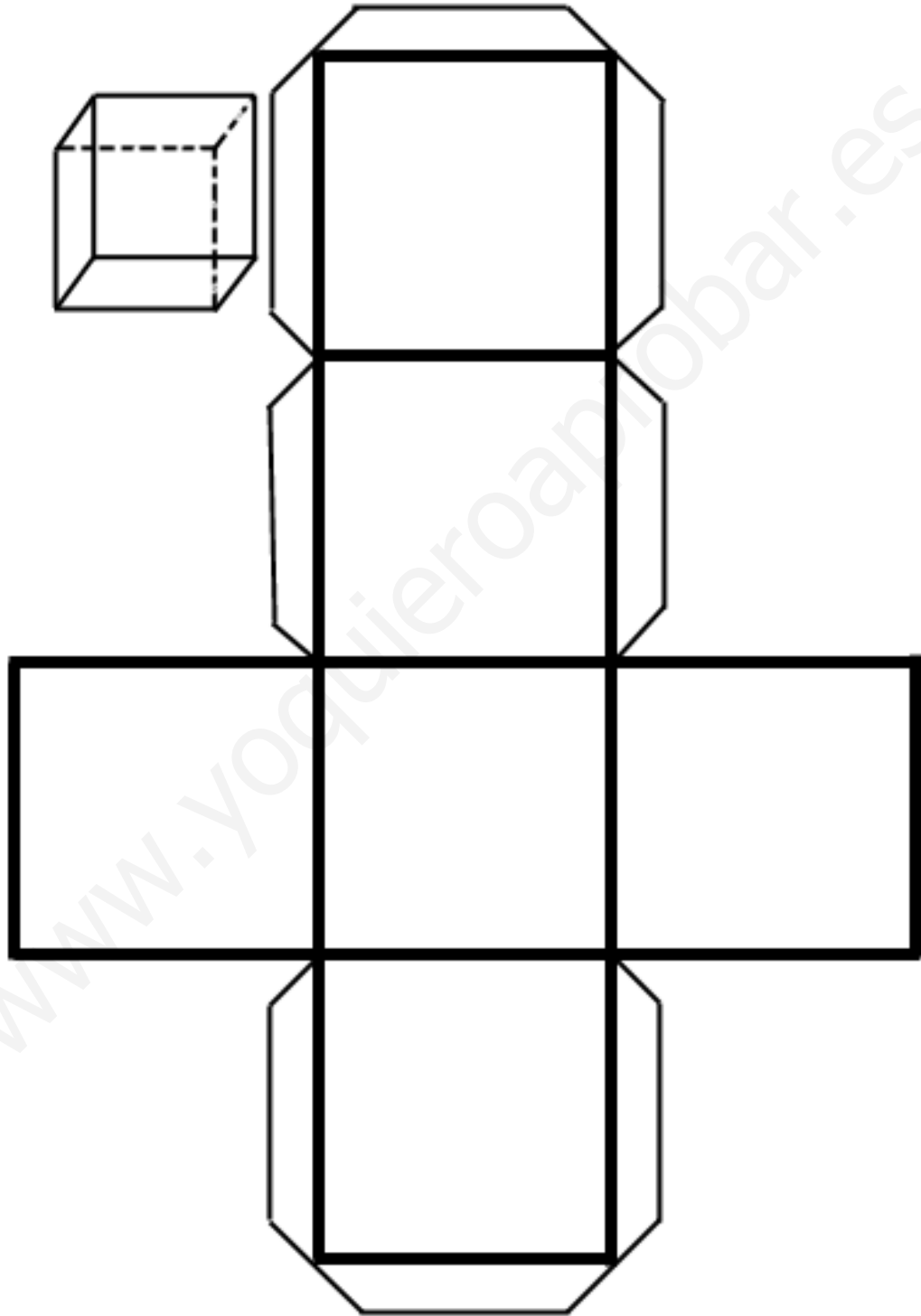

OCTAEDRO

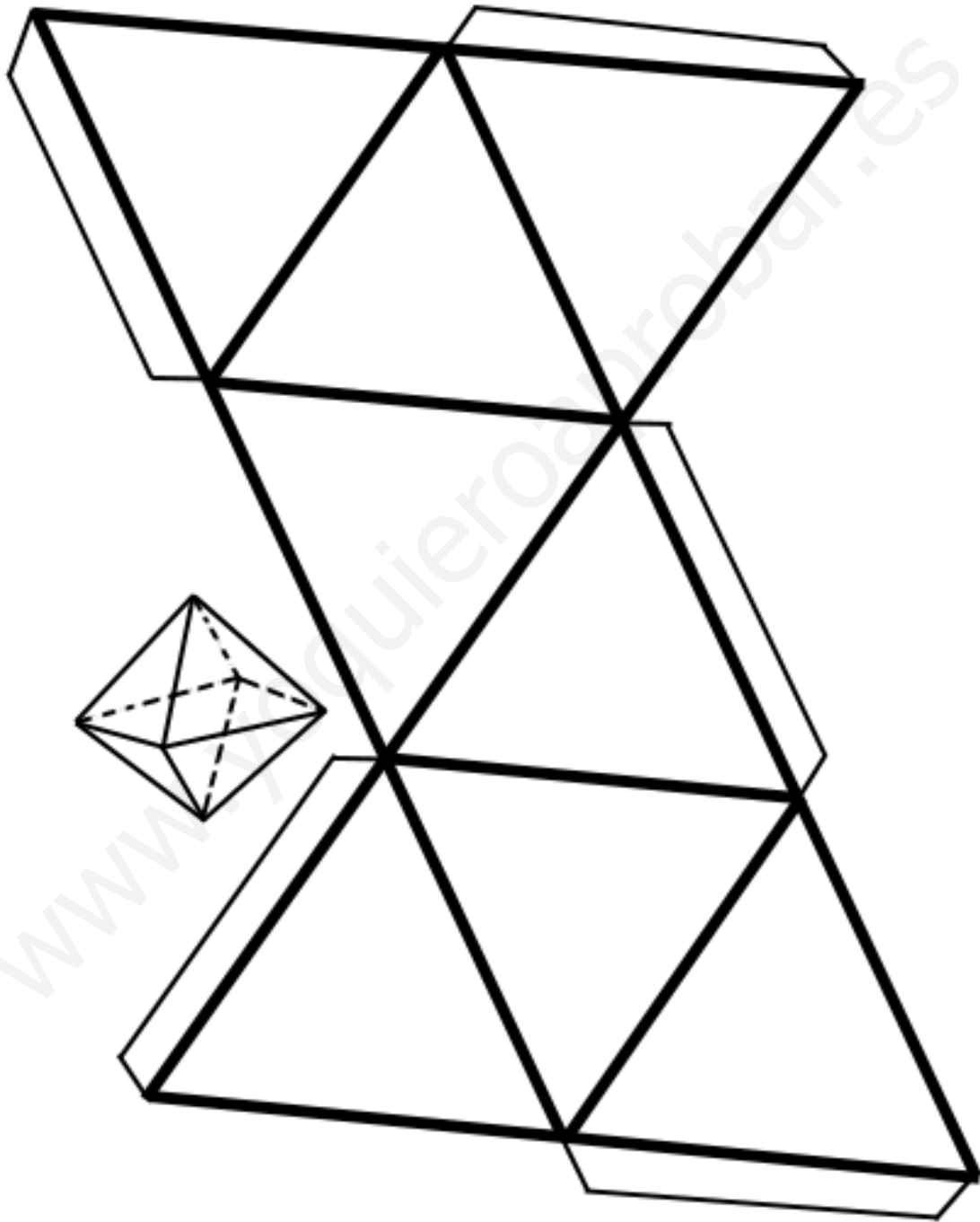

DODECAEDRO

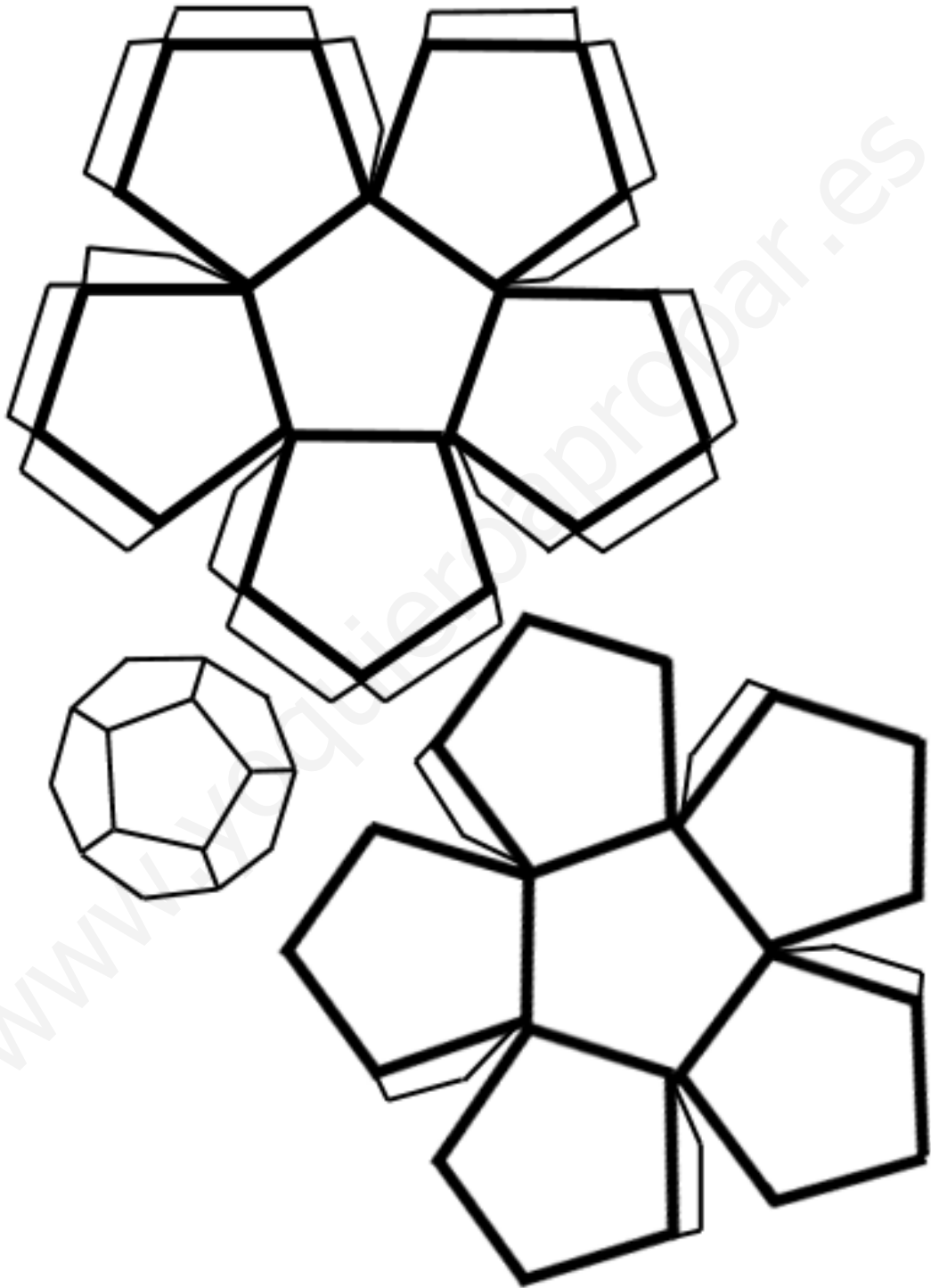

ICOSAEDRO

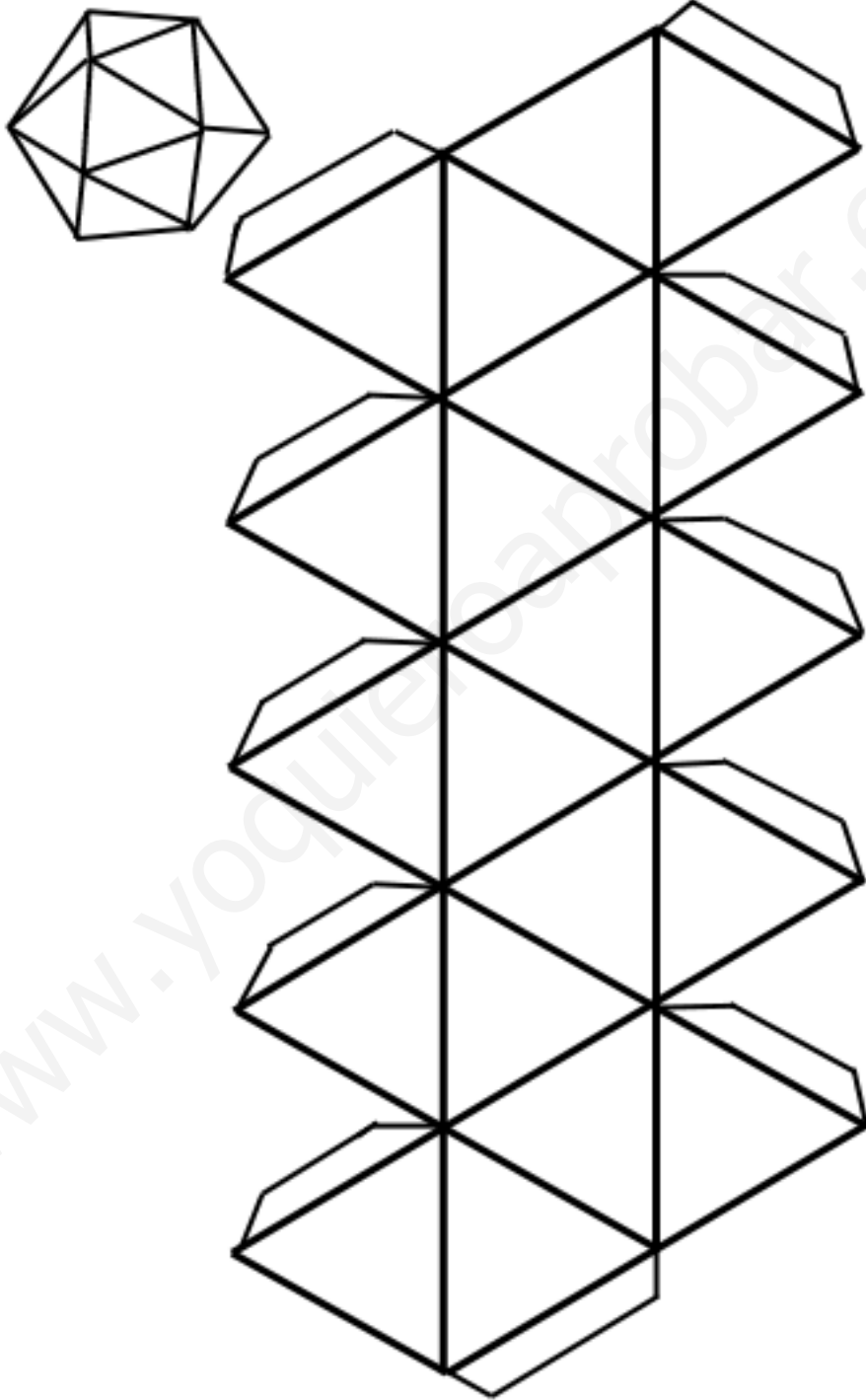

PRISMA TRIANGULAR

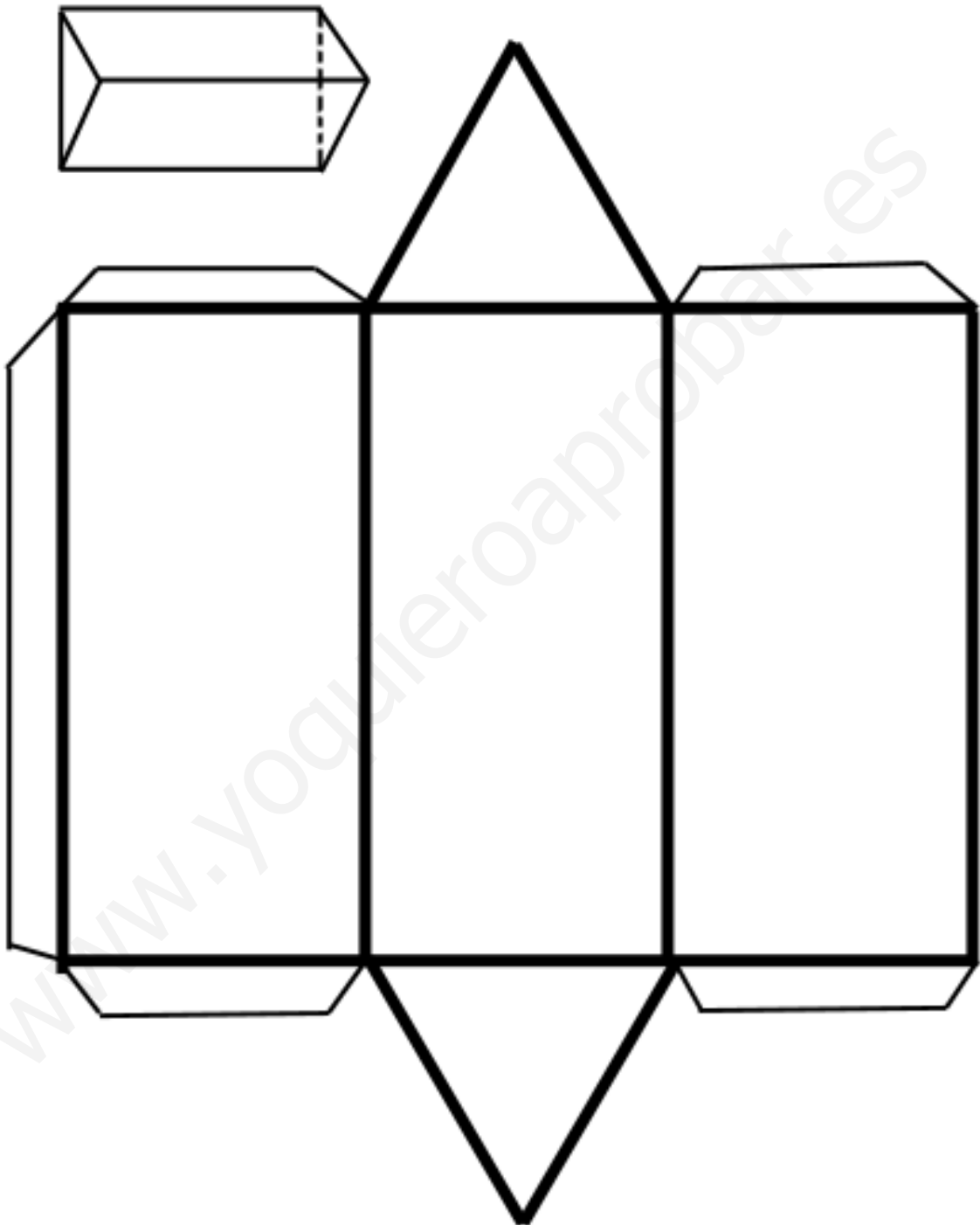

PRISMA CUADRANGULAR:

Este ejemplo se denomina **PARALELEPÍPEDO** porque las bases son paralelogramos.

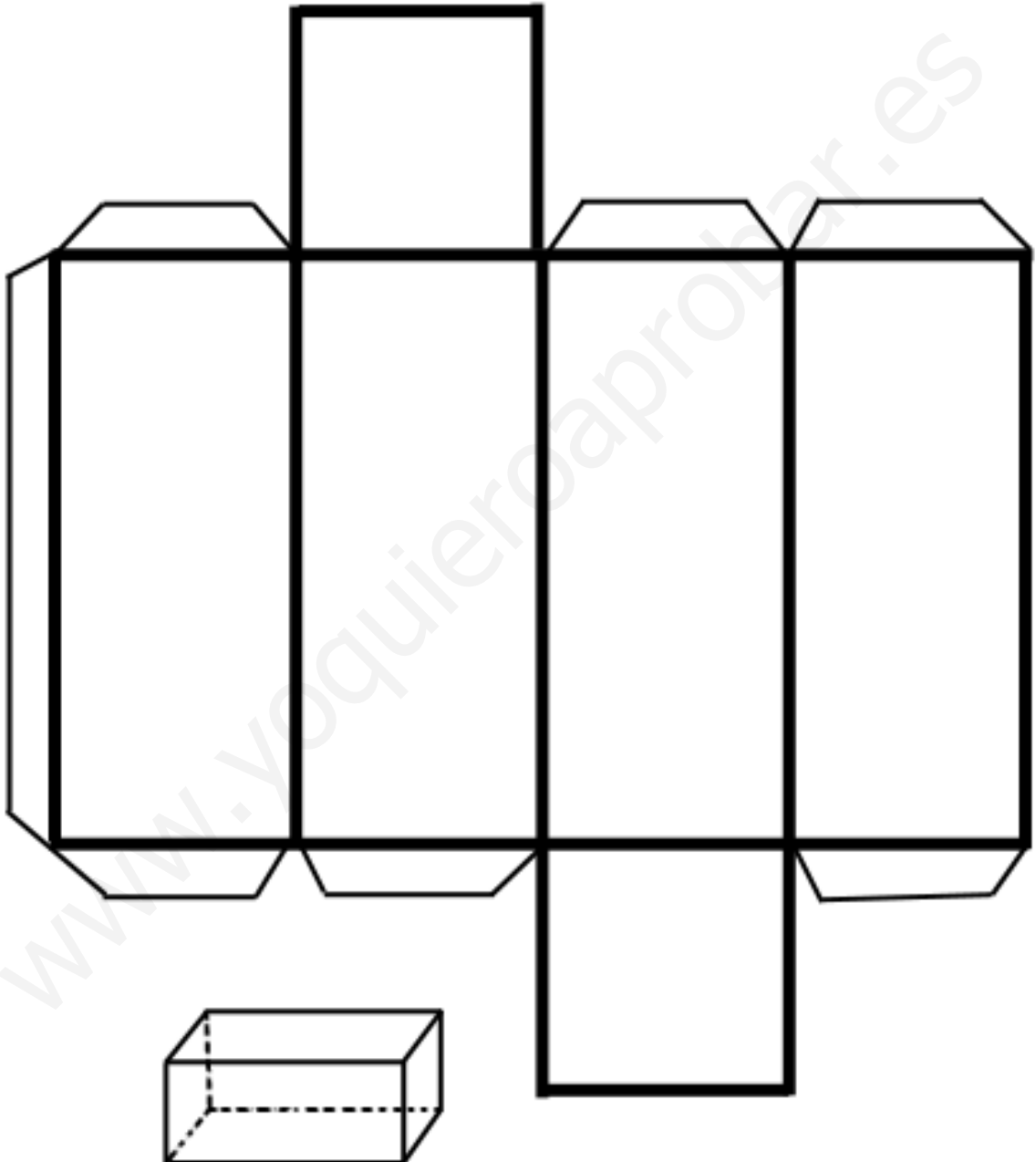

PRISMA PENTAGONAL

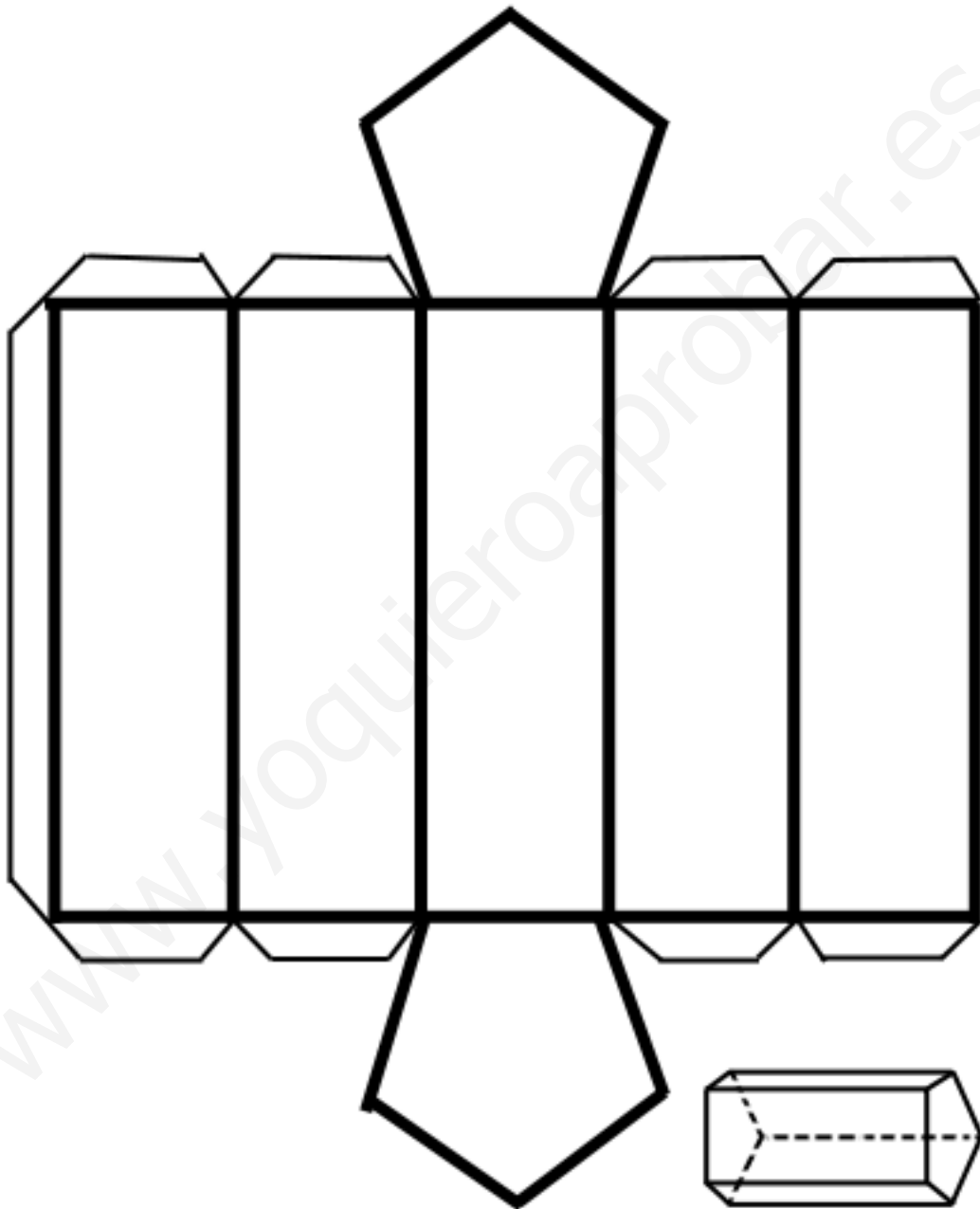

PRISMA HEXAGONAL

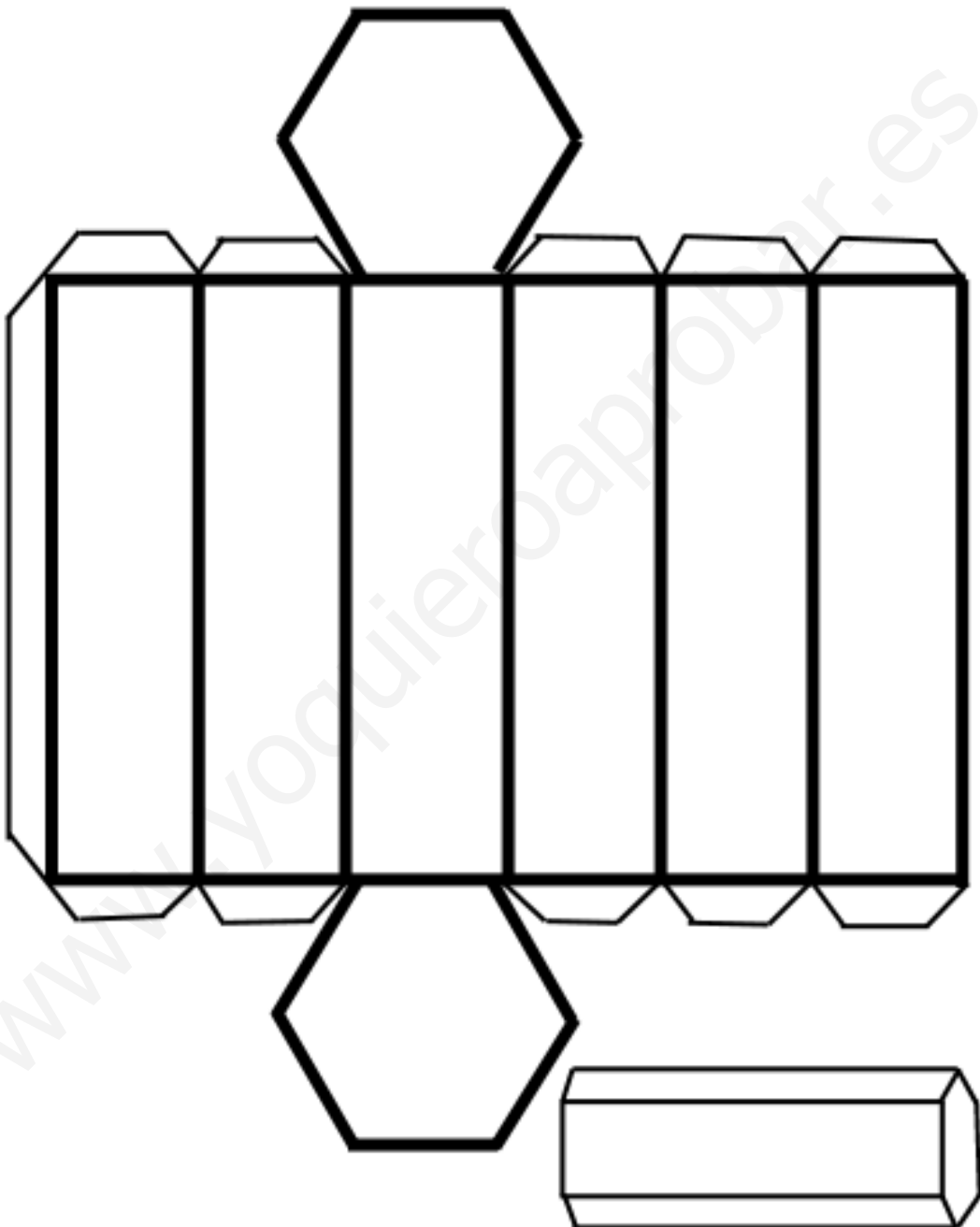

PIRÁMIDE TRIANGULAR

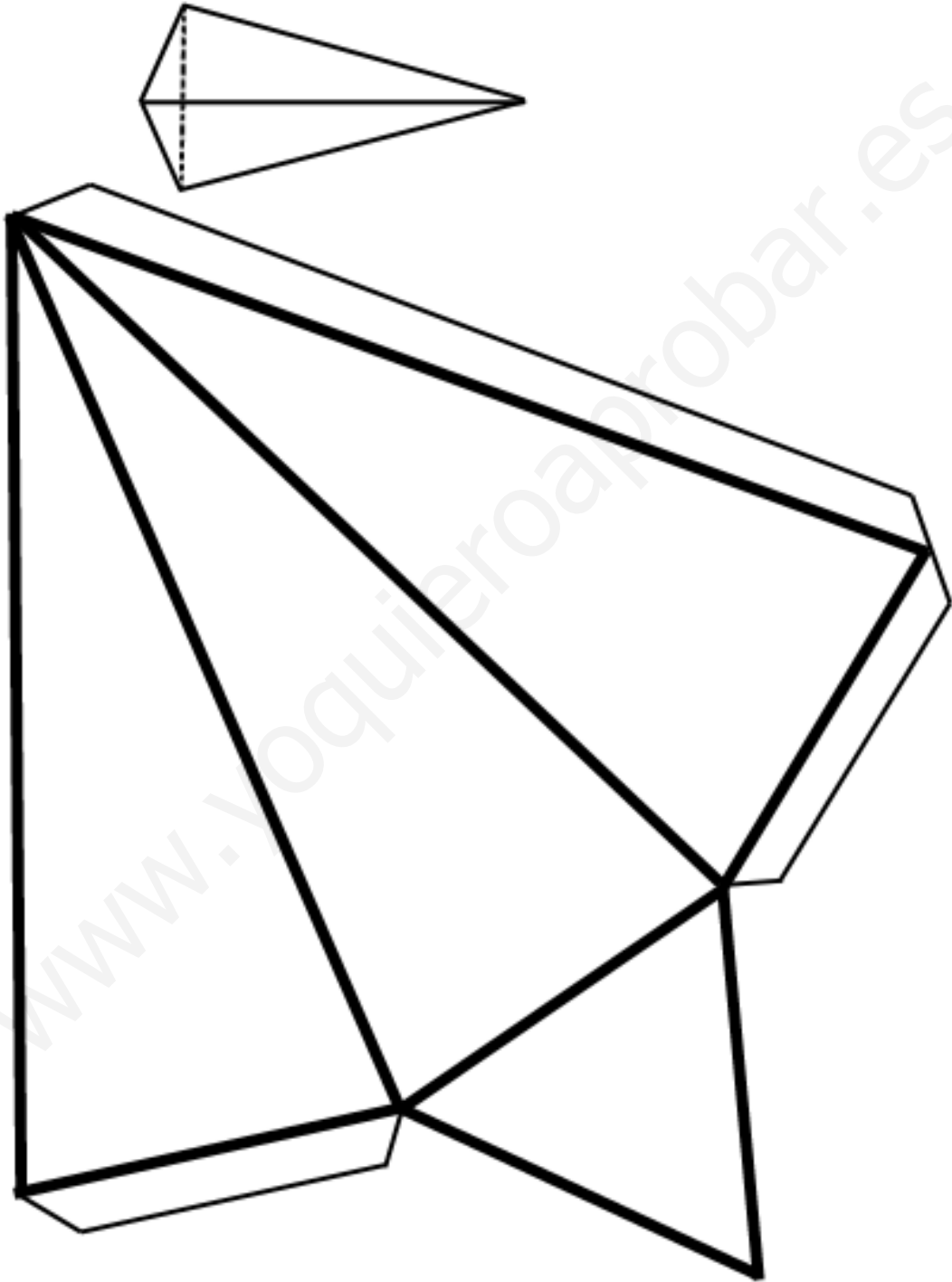

PIRÁMIDE CUADRANGULAR

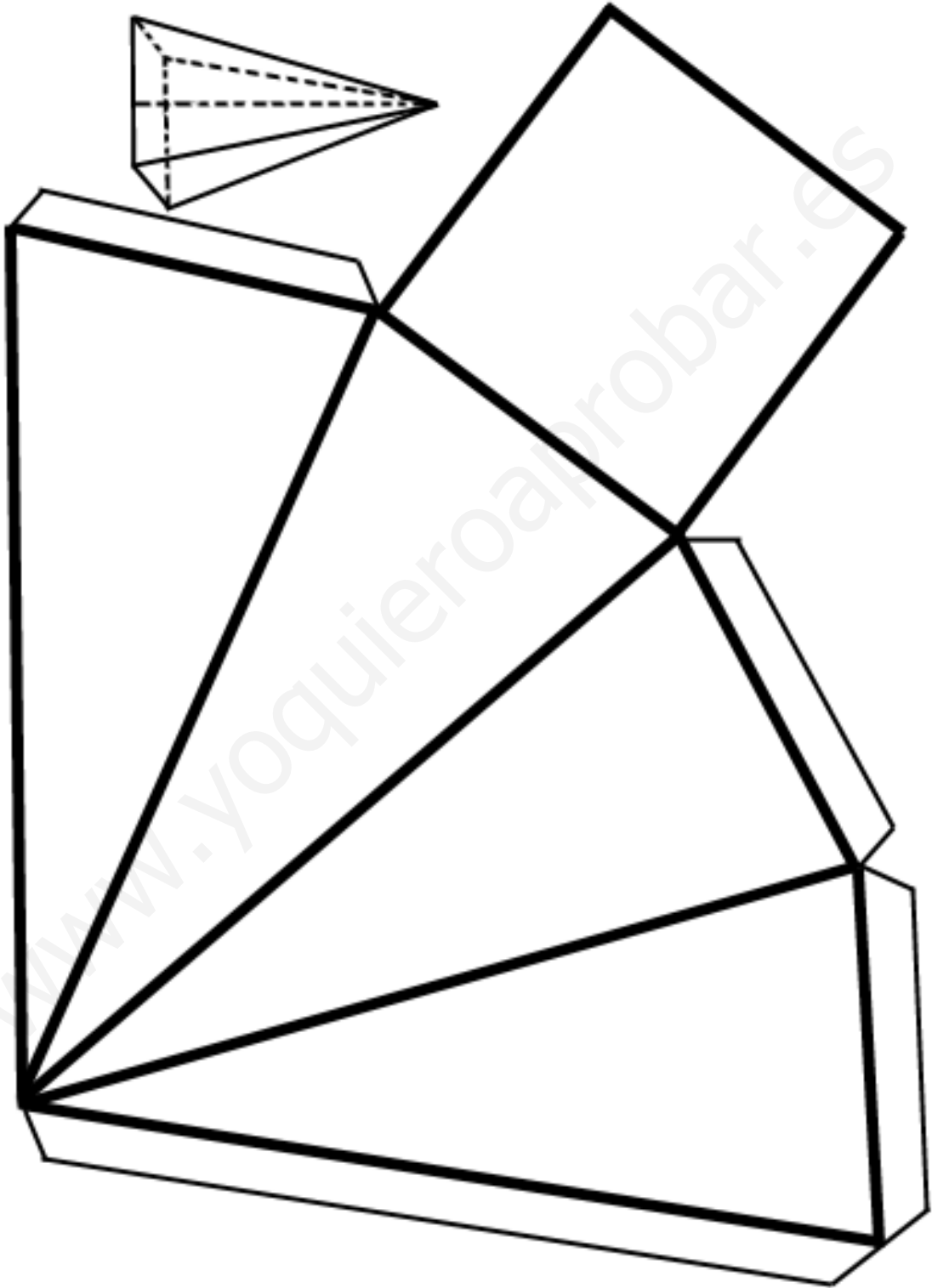

PIRÁMIDE PENTAGONAL

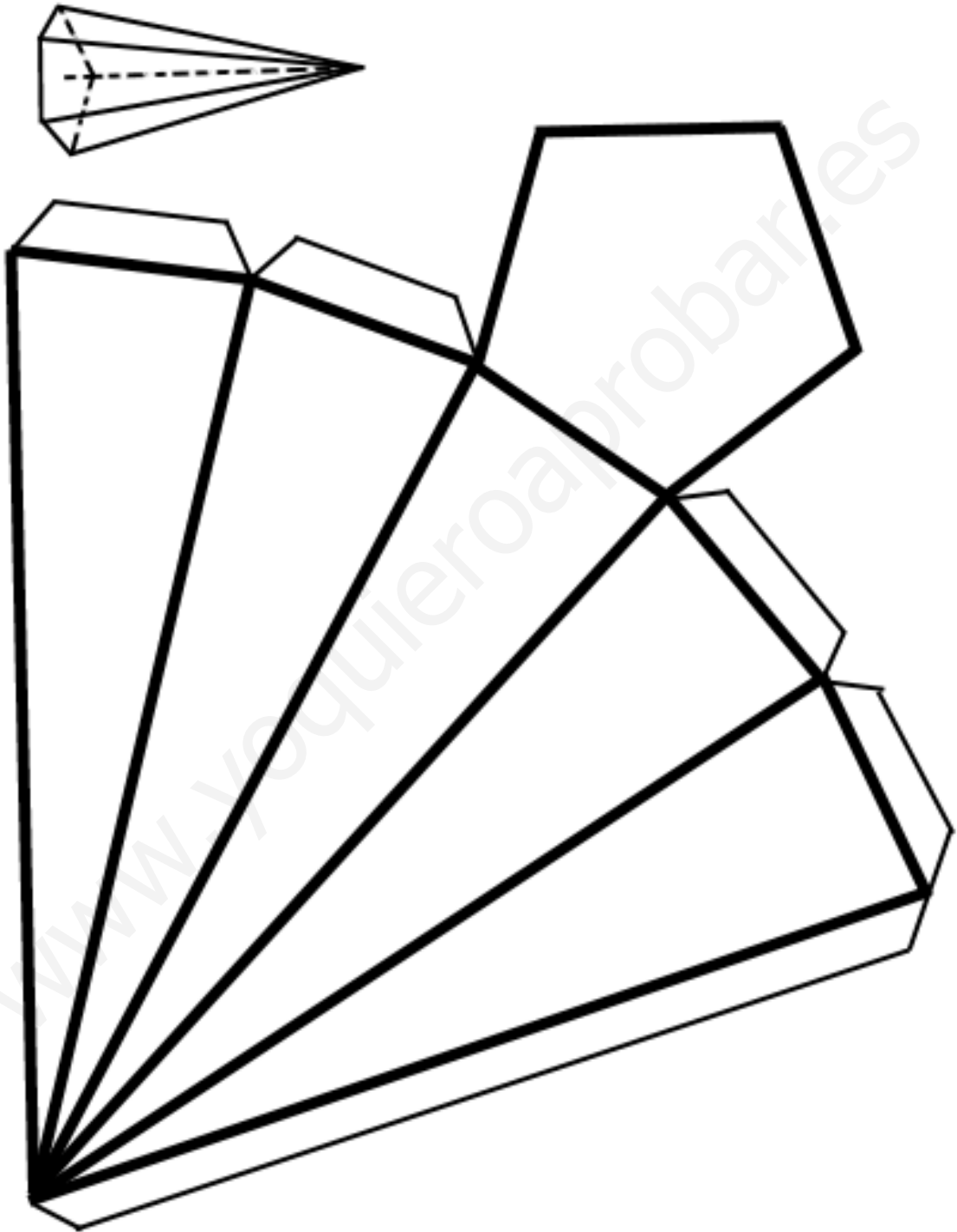

PIRÁMIDE HEXAGONAL

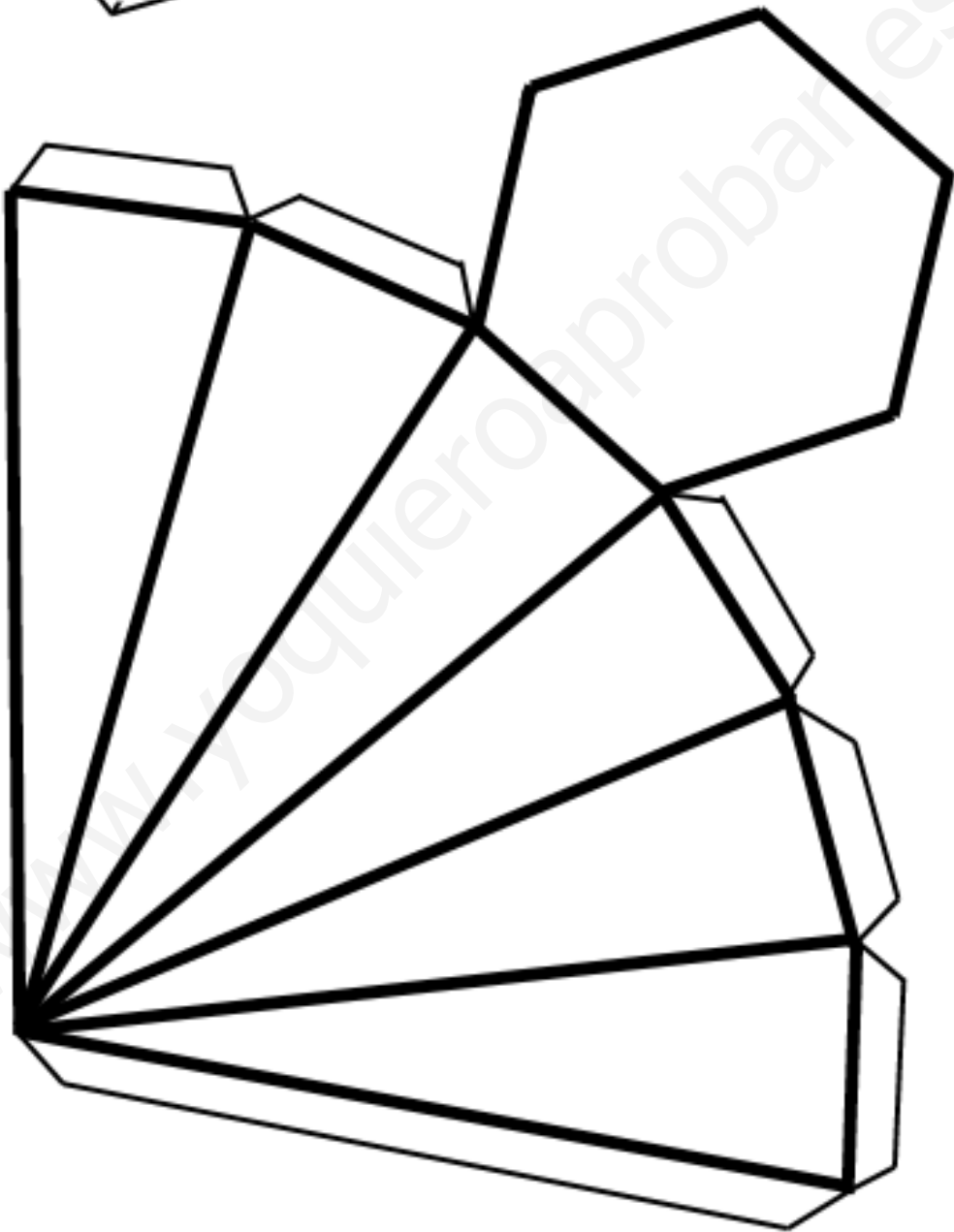
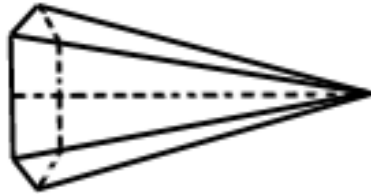

PIRÁMIDE OCTAGONAL

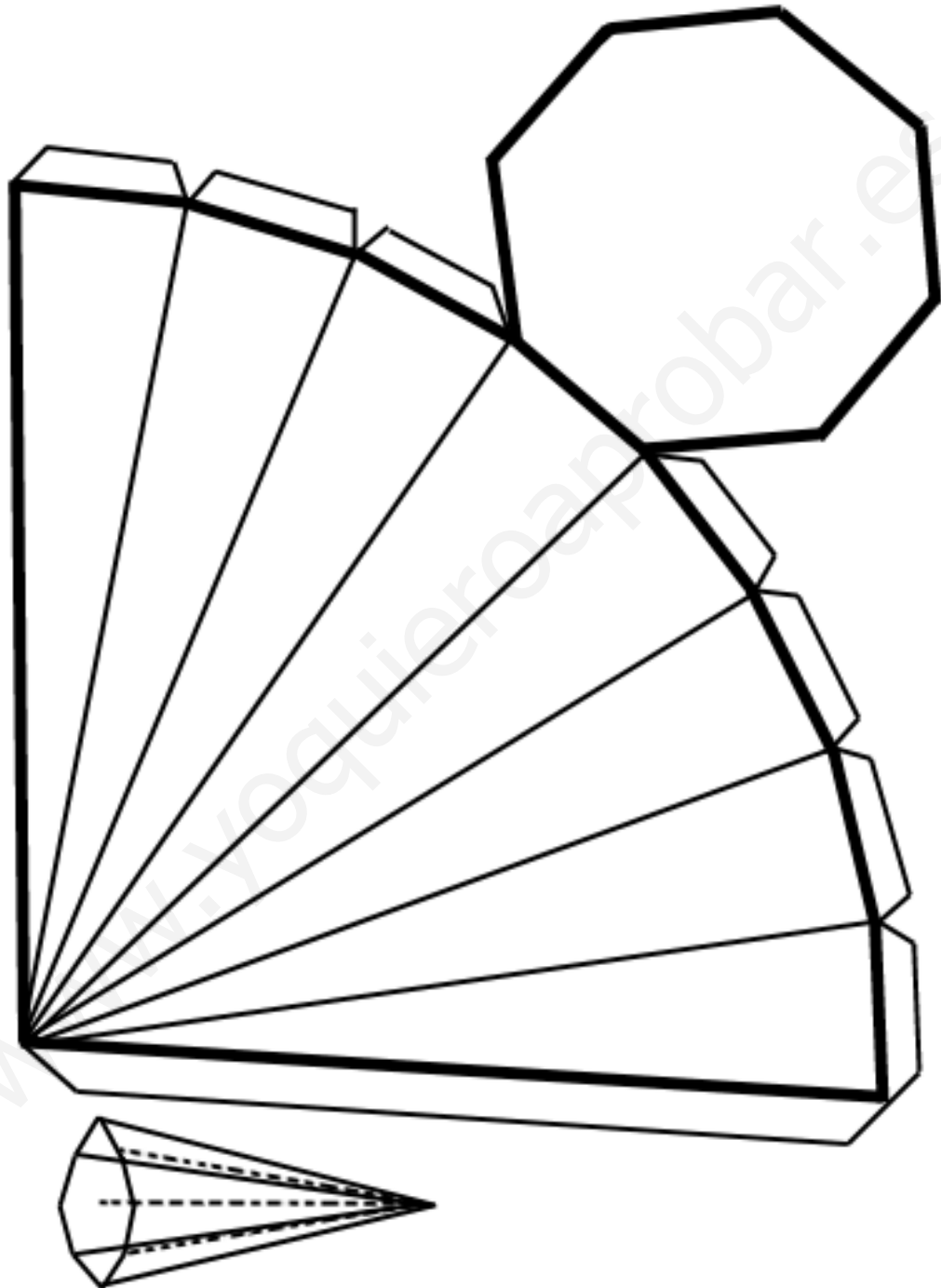

PIRÁMIDE CUADRANGULAR TRUNCADA

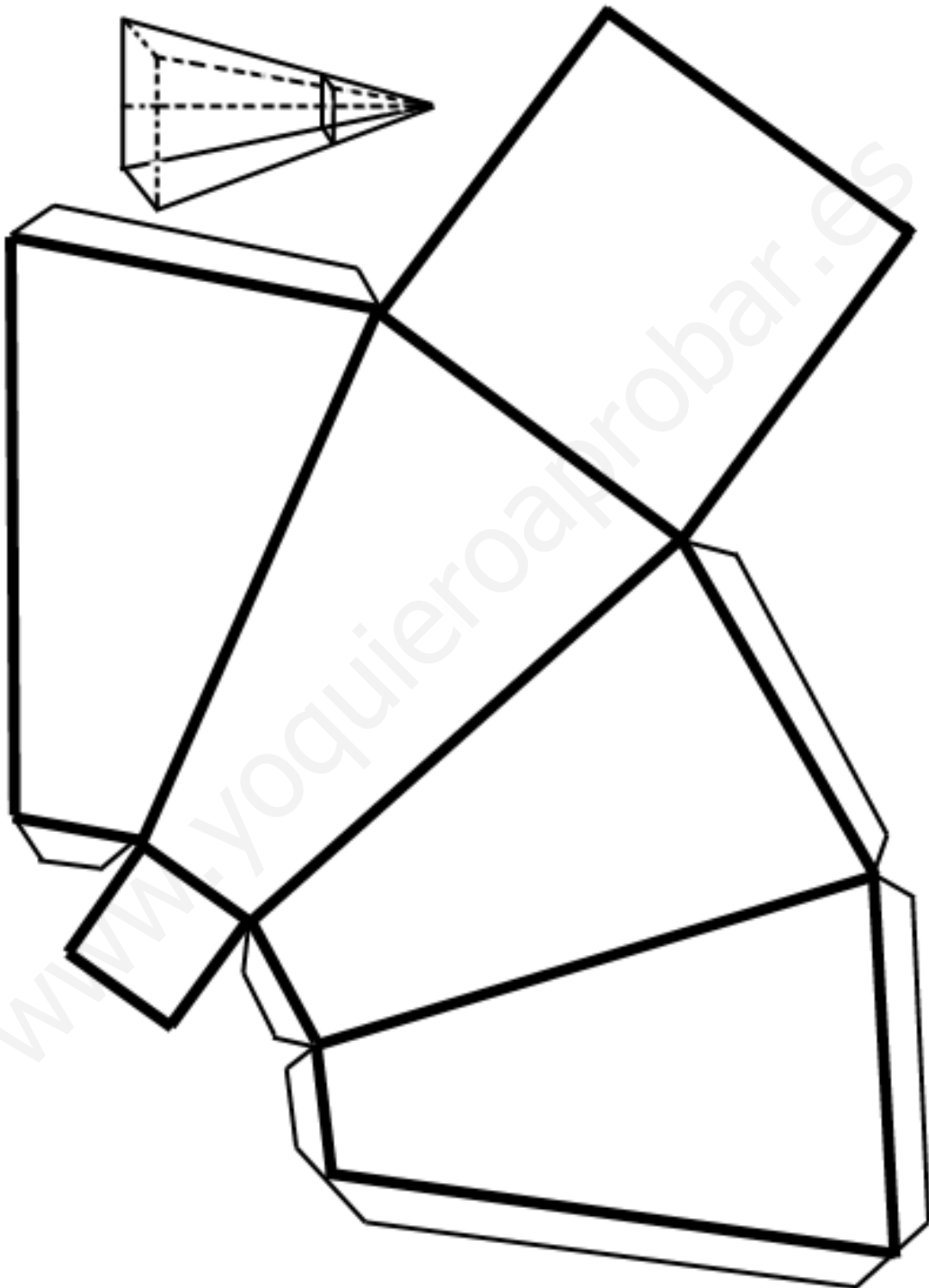

CILINDRO

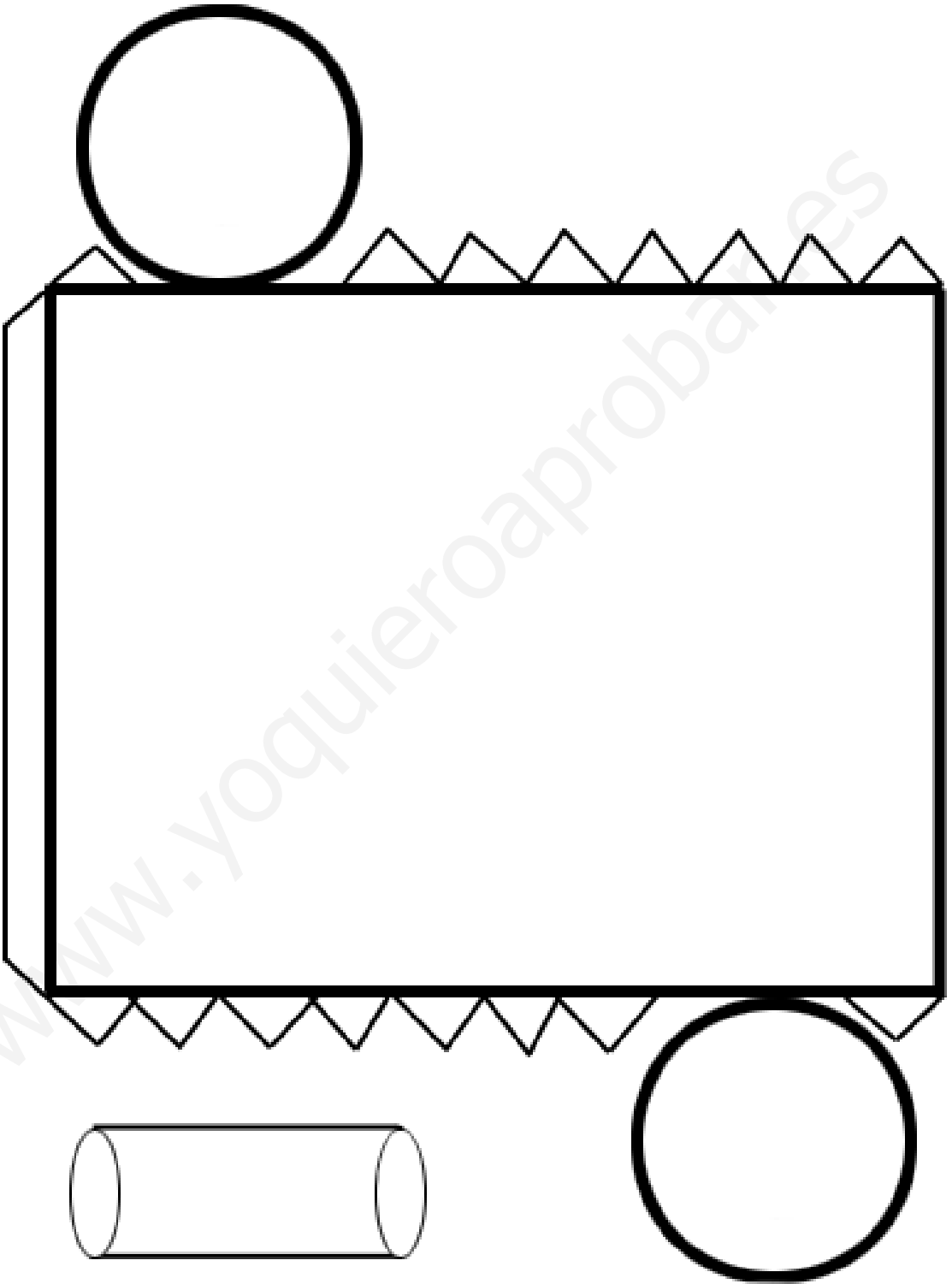

CONO

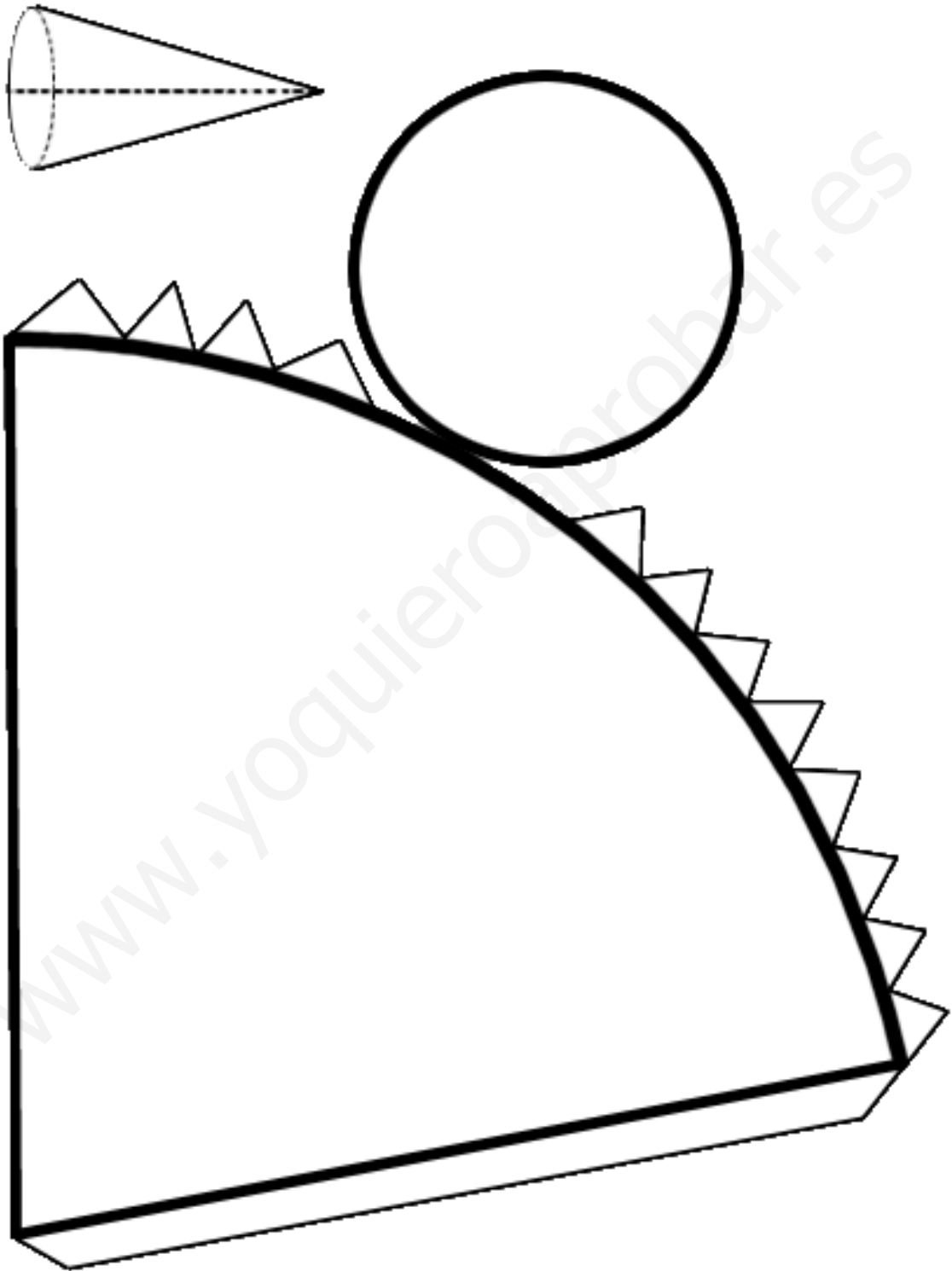

CONO TRUNCADO

